

Pump Performance Datasheet

Customer :	Quote Number / ID :	1471203
Customer ref. / PO :	Model :	40129 VLS
Tag Number : 001	Stages :	1
Service :	Based on curve number :	VLS_40129_4P Rev Aug21
Quantity : 1	Basic model number :	-
	Date last saved :	01/19/2023 4:54 PM

Operating Conditions		Liquid	
Flow, rated	: 566.6 USgpm	Liquid type	: Cold Water
Differential head / pressure, rated (requested)	: 122.5 ft	Additional liquid description	:
Differential head / pressure, rated (actual)	: 122.5 ft	Solids diameter, max	: 0.00 in
Suction pressure, rated / max	: 0.00 / 0.00 psi.g	Solids concentration, by volume	: 0.00 %
NPSH available, rated	: Ample	Temperature, max	: 68.00 deg F
Site Supply Frequency	: 60 Hz	Fluid density, rated / max	: 1.000 / 1.000 SG
		Viscosity, rated	: 1.00 cP
		Vapor pressure, rated	: 0.34 psi.a

Performance		Material	
Speed, rated	: 1760 rpm	Material selected	: Cast iron - 125#
Impeller diameter, rated	: 12.10 in	Pressure Data	
Impeller diameter, maximum	: 12.10 in	Maximum working pressure	: 64.21 psi.g
Impeller diameter, minimum	: 9.50 in	Maximum allowable working pressure	: 175.0 psi.g
Efficiency	: 72.68 %	Maximum allowable suction pressure	: 175.0 psi.g
NPSH required / margin required	: 16.43 / 0.00 ft	Hydrostatic test pressure	: 263.0 psi.g
nq (imp. eye flow) / S (imp. eye flow)	: 22 / 99 Metric units	Driver & Power Data (@Max density)	
MCSF	: 169.5 USgpm	Motor sizing specification	: Max power (non-overloading)
Head, maximum, rated diameter	: 148.4 ft	Margin over specification	: 0.00 %
Head rise to shutoff	: 19.53 %	Service factor	: 1.00
Flow, best eff. point	: 566.6 USgpm	Power, hydraulic	: 17.52 hp
Flow ratio, rated / BEP	: 100.00 %	Rated power (based on duty point)	: 24.11 hp
Diameter ratio (rated / max)	: 100.00 %	Max power (non-overloading)	: 27.35 hp
Head ratio (rated dia / max dia)	: 100.00 %	Nameplate motor rating	: 30.00 hp / 22.37 kW
Cq/Ch/Ce/Cn [ANSI/HI 9.6.7-2010]	: 1.00 / 1.00 / 1.00 / 1.00		
Selection status	: Acceptable		

Energy Indexes	
PEI (CL)	: 1.00
ER (CL)	: 0

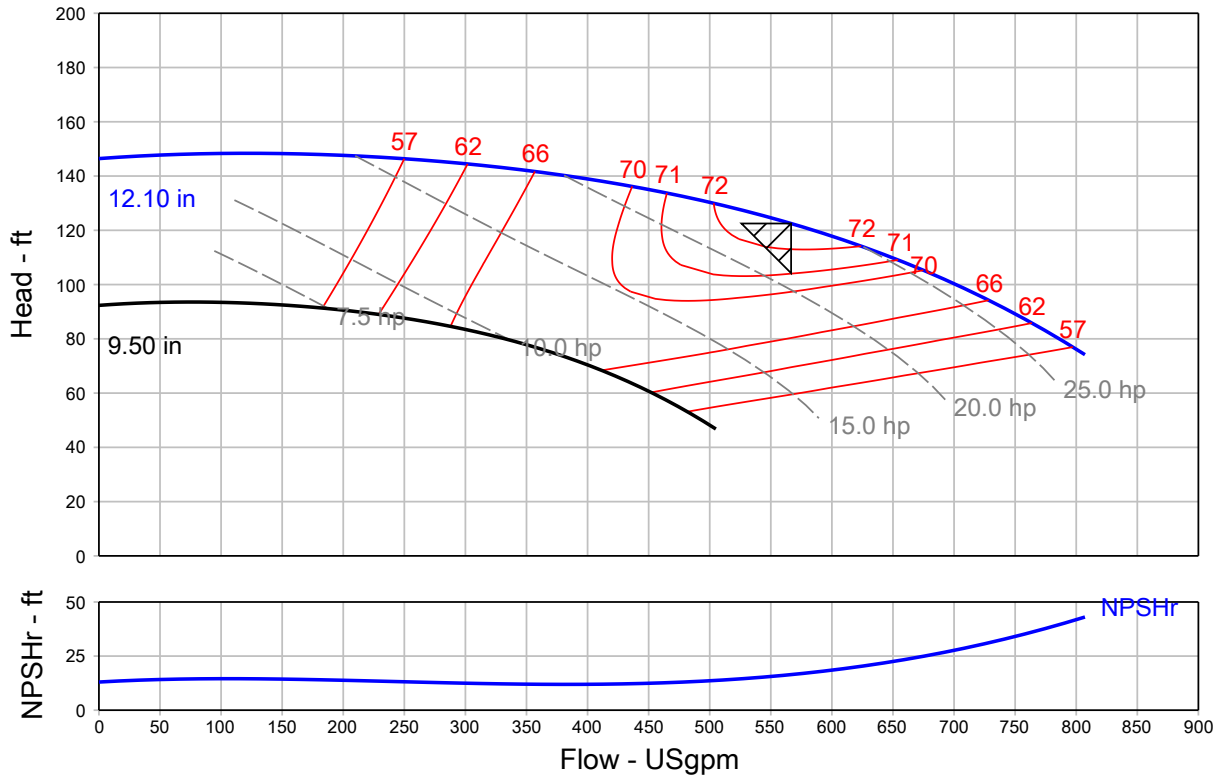

Grundfos Series VLS - In-Line Centrifugal Pump, Split Coupled

QUOTE NUMBER / ID 1471203	UNIT TAG 001	QUANTITY 1
REPRESENTATIVE	SERVICE	
ENGINEER	SUBMITTED BY	DATE
CONTRACTOR	APPROVED BY	DATE
	ORDER #	DATE



VLS 40129
1760 rpm

Part Number N/A

Conditions of Service		Pump Data		Motor Data	
Flow	566.6 USgpm	Impeller Diameter	12.10 in	Motor HP	30 HP
Head	122.5 ft	Max. Imp. Dia.	12.10 in	BHP	24.11 HP
Liquid	Cold Water	Min. Imp. Dia.	9.50 in	Enclosure	TEFC
Temperature	68.00 deg F	Efficiency	72.68 %	Voltage	230/460 V
NPSHr	16.43 ft	Suction	4 in.	Phase	3 Phase
Viscosity	1.00 cP	Discharge	4 in.	Cycle	60
Specific Gravity	1.000 SG	PEI (CL)	1	Frame Size	286TC
		ER (CL)	0		

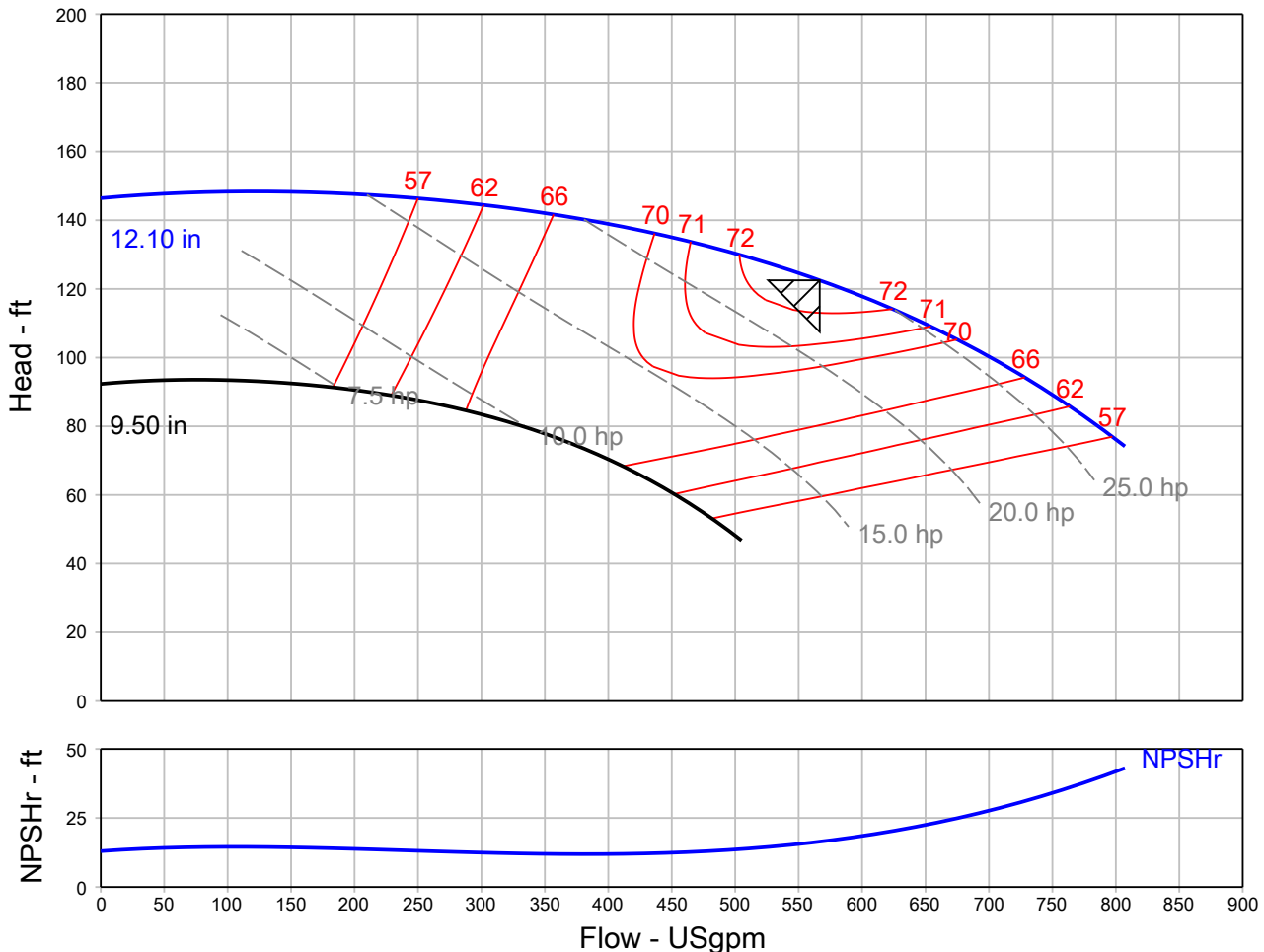

Grundfos Series VLS - In-Line Centrifugal Pump, Split Coupled

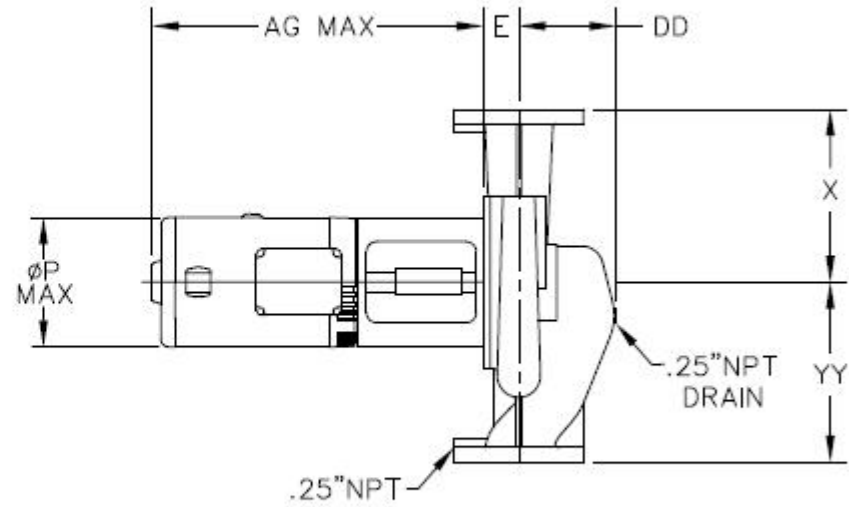
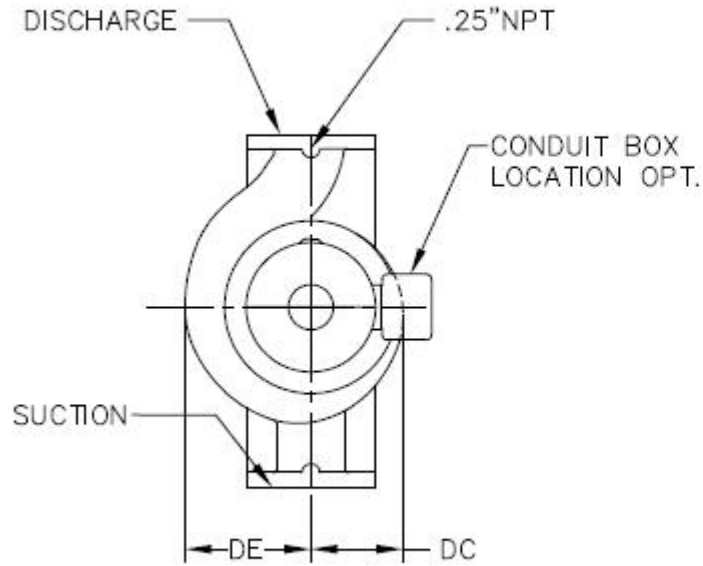

NOT FOR CONSTRUCTION, unless certified and referenced on order

Units	Frame	S x D	AG (Max)	DC	DD	DE	E	P (Max)	X	YY	Weight
inches	286TC	4 X 4	39.50	7.72	6.63	9.56	1.94	18.50	13.00	13.00	TBD