

## Pump Performance Datasheet

Customer :	Quote Number / ID :	1471203
Customer ref. / PO :	Model :	20959 VLS
Tag Number : 001	Stages :	1
Service :	Based on curve number :	VLS_20959_4P Rev 0
Quantity : 1	Basic model number :	-
	Date last saved :	01/18/2023 4:11 PM

Operating Conditions	Liquid
Flow, rated : 139.9 USgpm	Liquid type : Cold Water
Differential head / pressure, rated (requested) : 71.36 ft	Additional liquid description :
Differential head / pressure, rated (actual) : 71.36 ft	Solids diameter, max : 0.00 in
Suction pressure, rated / max : 0.00 / 0.00 psi.g	Solids concentration, by volume : 0.00 %
NPSH available, rated : Ample	Temperature, max : 68.00 deg F
Site Supply Frequency : 60 Hz	Fluid density, rated / max : 1.000 / 1.000 SG
	Viscosity, rated : 1.00 cP
	Vapor pressure, rated : 0.34 psi.a

Performance	Material
Speed, rated : 1760 rpm	Material selected : Cast iron - 125#
Impeller diameter, rated : 8.72 in	
Impeller diameter, maximum : 9.60 in	
Impeller diameter, minimum : 7.00 in	
Efficiency : 62.85 %	
NPSH required / margin required : 8.39 / 0.00 ft	
nq (imp. eye flow) / S (imp. eye flow) : 14 / 77 Metric units	
MCSF : 37.01 USgpm	
Head, maximum, rated diameter : 81.78 ft	
Head rise to shutoff : 13.32 %	
Flow, best eff. point : 139.9 USgpm	
Flow ratio, rated / BEP : 100.00 %	
Diameter ratio (rated / max) : 90.83 %	
Head ratio (rated dia / max dia) : 77.68 %	
Cq/Ch/Ce/Cn [ANSI/HI 9.6.7-2010] : 1.00 / 1.00 / 1.00 / 1.00	
Selection status : Acceptable	

Pressure Data
Maximum working pressure : 35.39 psi.g
Maximum allowable working pressure : 175.0 psi.g
Maximum allowable suction pressure : 175.0 psi.g
Hydrostatic test pressure : 263.0 psi.g

Driver & Power Data (@Max density)
Motor sizing specification : Max power (non-overloading)
Margin over specification : 0.00 %
Service factor : 1.00
Power, hydraulic : 2.52 hp
Rated power (based on duty point) : 4.01 hp
Max power (non-overloading) : 4.99 hp
Nameplate motor rating : 5.00 hp / 3.73 kW

Energy Indexes
PEI (CL) : 0.90
ER (CL) : 10

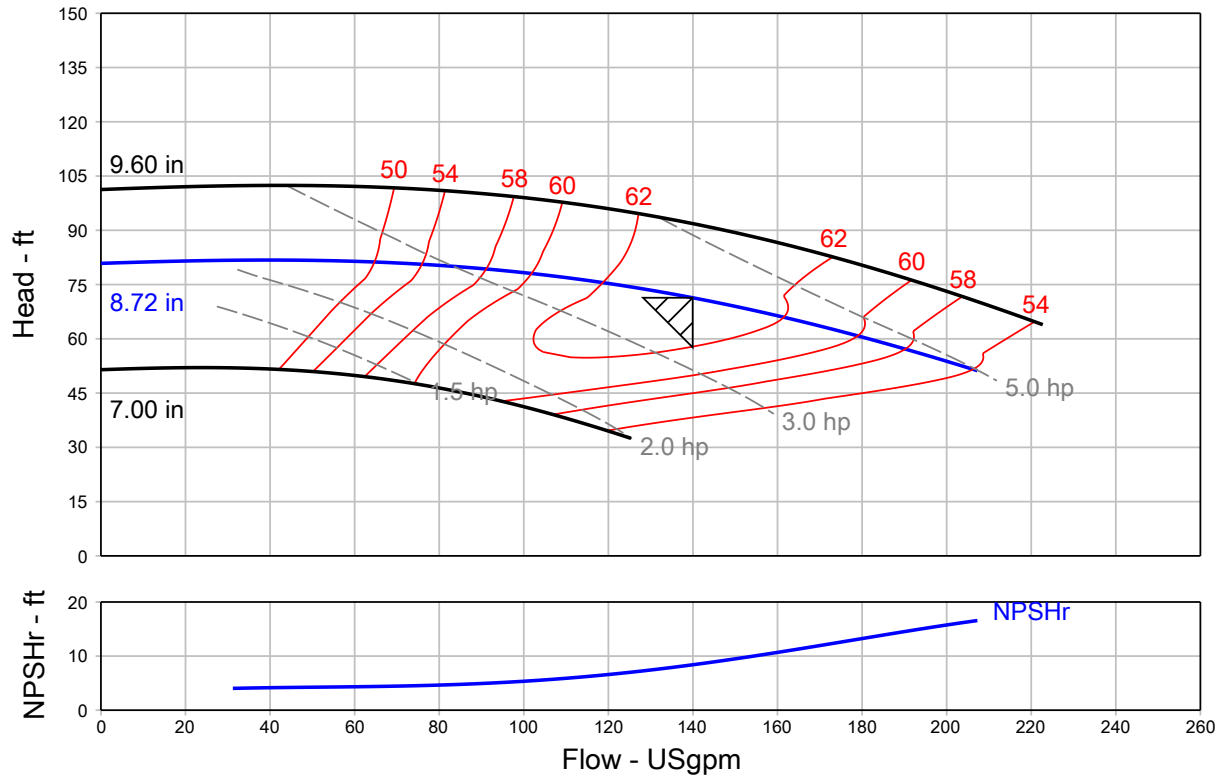

## Grundfos Series VLS - In-Line Centrifugal Pump, Split Coupled

QUOTE NUMBER / ID 1471203	UNIT TAG 001	QUANTITY 1
REPRESENTATIVE	SERVICE	
ENGINEER	SUBMITTED BY	DATE
CONTRACTOR	APPROVED BY	DATE
	ORDER #	DATE



**VLS 20959**  
**1760 rpm**

Part Number N/A

Conditions of Service		Pump Data		Motor Data	
Flow	139.9 USgpm	Impeller Diameter	8.72 in	Motor HP	5 HP
Head	71.36 ft	Max. Imp. Dia.	9.60 in	BHP	4.01 HP
Liquid	Cold Water	Min. Imp. Dia.	7.00 in	Enclosure	TEFC
Temperature	68.00 deg F	Efficiency	62.85 %	Voltage	230/460 V
NPSHr	8.39 ft	Suction	2 in.	Phase	3 Phase
Viscosity	1.00 cP	Discharge	2 in.	Cycle	60
Specific Gravity	1.000 SG	PEI (CL)	0.9	Frame Size	184TC
		ER (CL)	10		

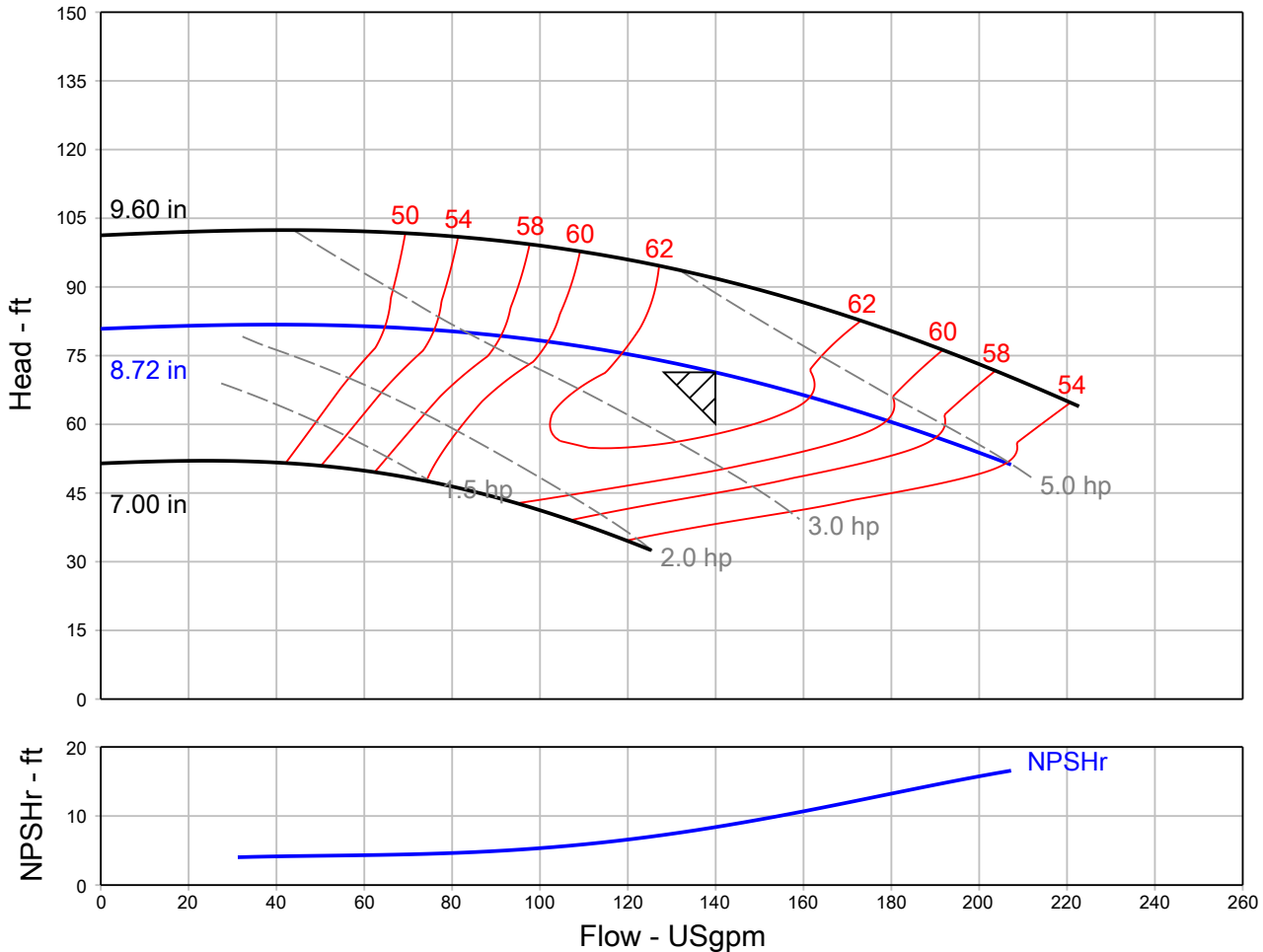

**Grundfos Series VLS - In-Line Centrifugal Pump, Split Coupled**

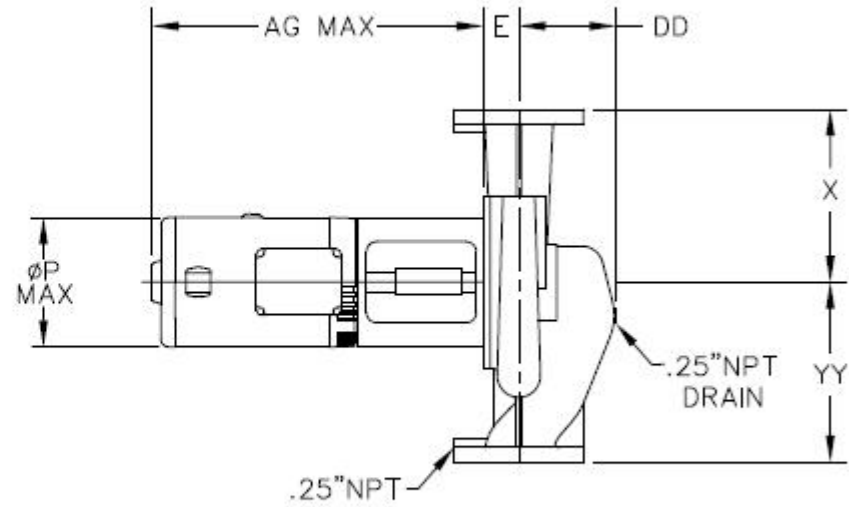
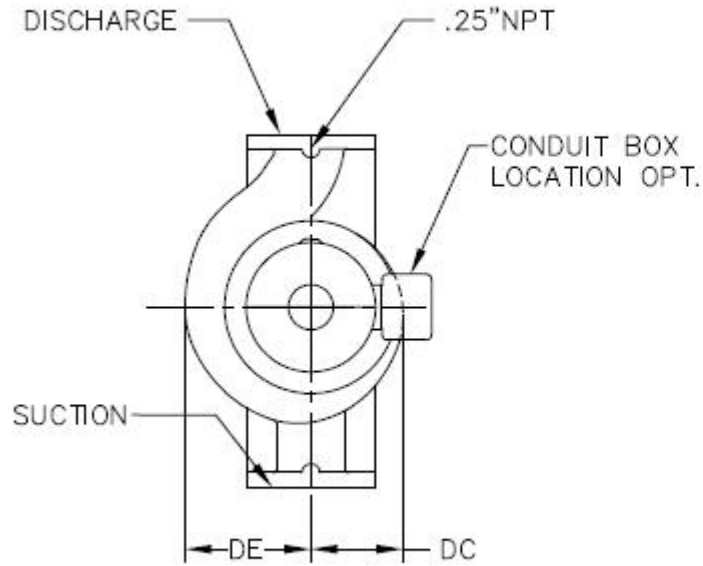

NOT FOR CONSTRUCTION, unless certified and referenced on order

Units	Frame	S x D	AG (Max)	DC	DD	DE	E	P (Max)	X	YY	Weight
inches	184TC	2 X 2	28.50	6.00	4.88	6.25	1.50	13.25	9.00	9.00	TBD