

PROJECT: _____	UNIT TAG: _____	QUANTITY: _____
REPRESENTATIVE: _____	TYPE OF SERVICE: _____	DATE: _____
ENGINEER: _____	SUBMITTED BY: _____	DATE: _____
CONTRACTOR: _____	APPROVED BY: _____	DATE: _____
	ORDER NO.: _____	DATE: _____



UPS 32-80 F

UPS is a three-speed circulator pump designed for heating and air-conditioning systems and is also used for central and district heating systems. The pump provides reliable and maintenance-free operation.

Note! Product picture may differ from actual product

Conditions of Service		Pump Data		Motor Data	
Liquid:	Water	Maximum operating pressure:	145.04 psi	Max. power input:	280 W
Temperature:	140 °F	Liquid temperature range:	14 .. 248 °F	Rated voltage:	460 V
Specific Gravity:	0.985	Maximum ambient temperature:	104 °F	Mains frequency:	60 Hz
		Approvals:	CUL	Enclosure class:	X4D
		Type of connection:	F	Insulation class:	F
		Flange standard:	USA Oval	Motor protection:	CONTACT
		Pipe connection:	GF 15/26	Thermal protection:	external
		Product number:	96402711		

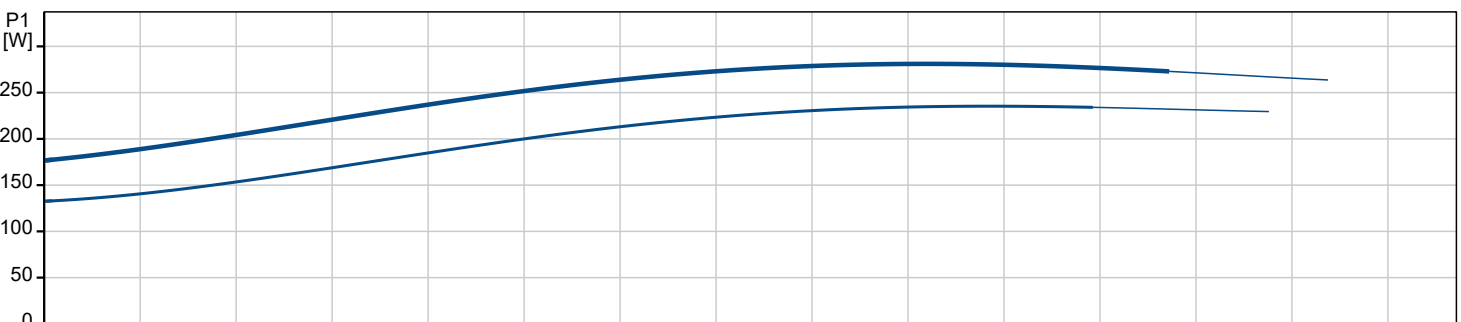
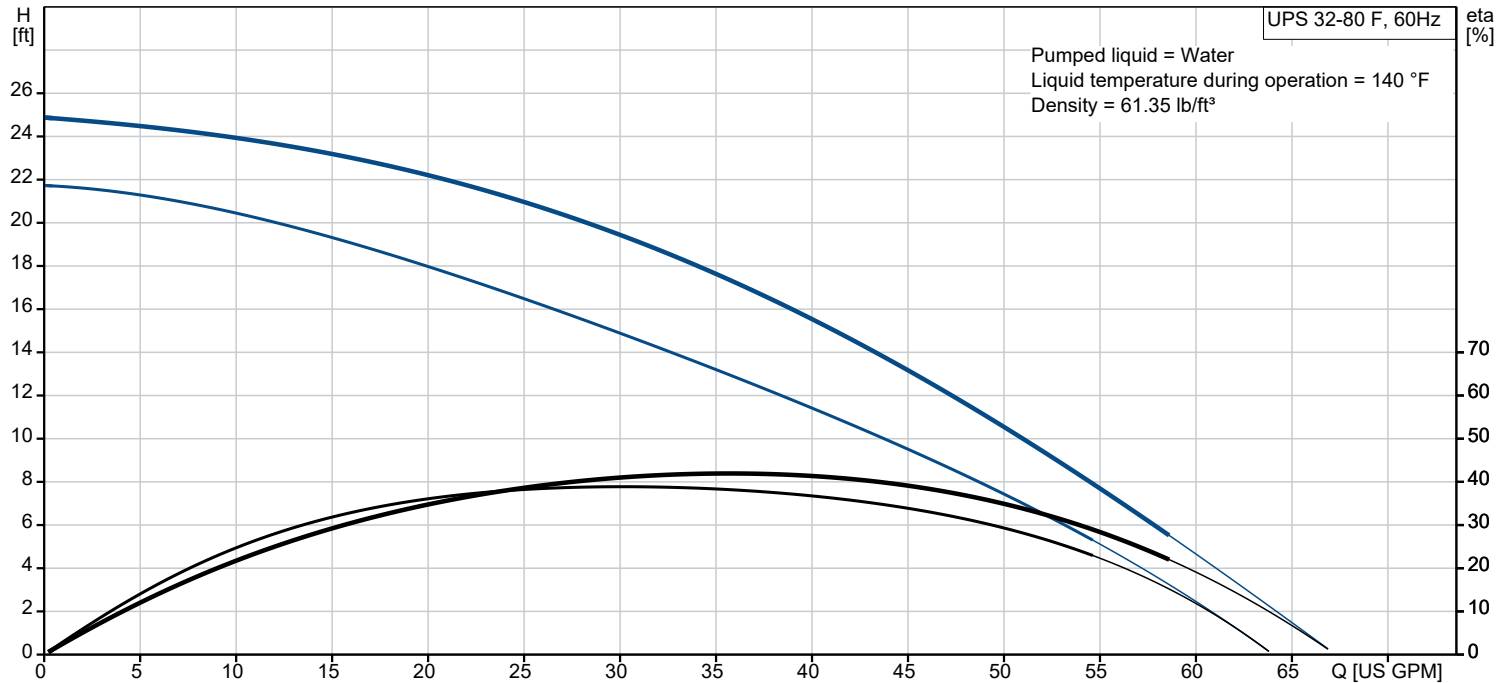

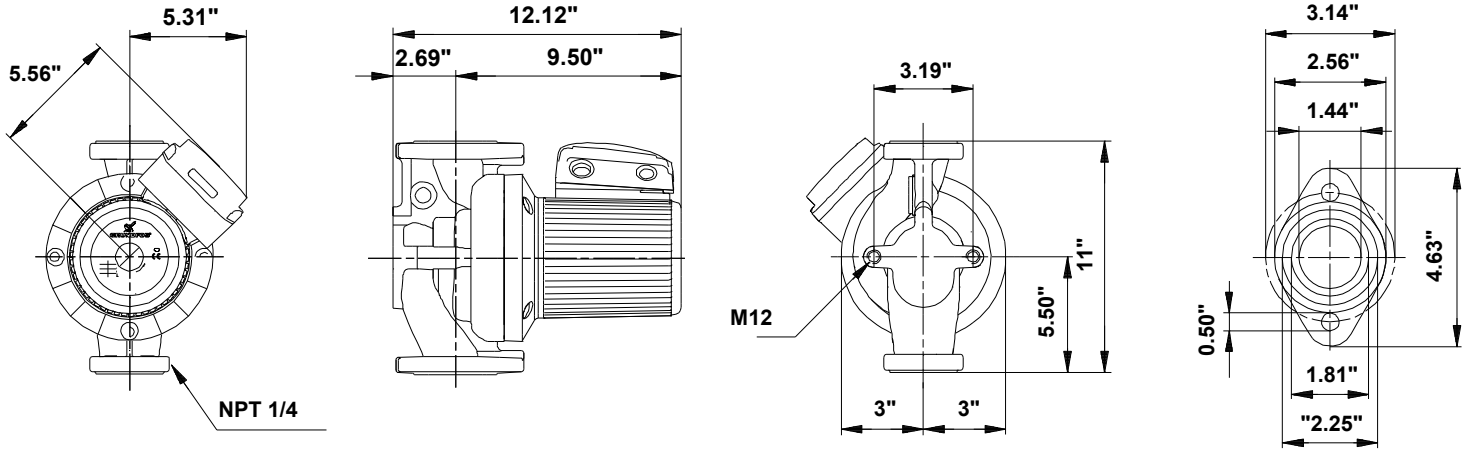

Materials:

- Pump housing: Cast iron
- Pump housing: EN-JL1040
- Pump housing: ASTM 35 B - 40 B
- Impeller: Stainless steel
- Impeller: DIN W.-Nr. 1.4301
- Impeller: AISI 304

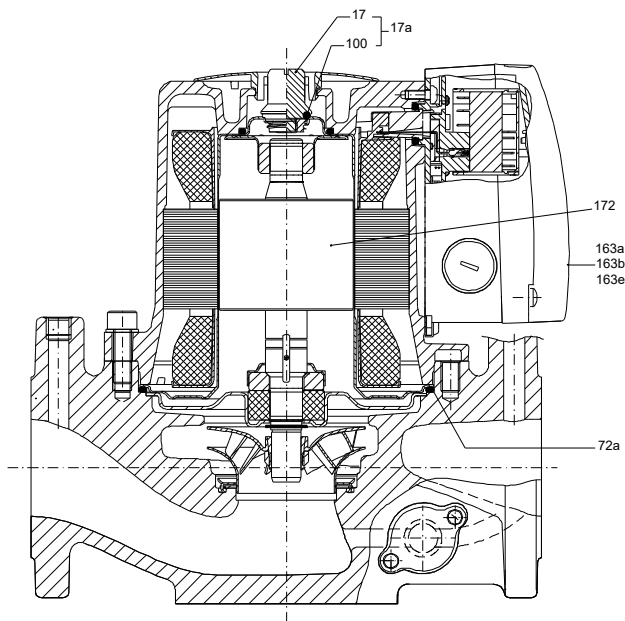

Qty.	Description
1	<p>UPS 32-80 F Product No.: 96402711 The pump is of the canned rotor type, i.e. pump and motor form an integral unit without shaft seal and with only two gaskets for sealing. The bearings are lubricated by the pumped liquid.</p> <p>In order to avoid problems in connection with disposal, great importance has been attached to using as few different materials as possible. The pump is characterized by:</p> <ul style="list-style-type: none"> * 2 speed motor. * Ceramic radial bearings. * Carbon axial bearing. * Stainless steel rotor can, bearing plate and rotor cladding. * Aluminium alloy stator housing. * Cast iron pump housing. * Stator with built-in thermal switch. <p>The motor is a 3-phase motor.</p> <p>The pump is supplied with a standard module in the terminal box. The standard module is to be connected to the mains supply via external contactor.</p> <p>Controls:</p> <p>Relay: without relay</p> <p>Liquid:</p> <p>Pumped liquid: Water Liquid temperature range: 14 .. 248 °F Selected liquid temperature: 140 °F Density: 61.35 lb/ft³</p> <p>Technical:</p> <p>Approvals: CUL</p> <p>Materials:</p> <p>Pump housing: Cast iron EN-JL1040 ASTM 35 B - 40 B</p> <p>Impeller: Stainless steel DIN W.-Nr. 1.4301 AISI 304</p> <p>Installation:</p> <p>Range of ambient temperature: 32 .. 104 °F Maximum operating pressure: 145.04 psi Flange standard: USA Oval Type of connection: F Pipe connection: GF 15/26 Pressure rating: 145 psi Port-to-port length: 11 in</p> <p>Electrical data:</p> <p>Power input in speed 2: 235 W Max. power input: 280 W Mains frequency: 60 Hz Rated voltage: 3 x 460 V Current in speed 2: 0.36 A Current in speed 3: 0.55 A Cos phi in speed 2: 0.82</p>



Company name: Hurley Engineering

Created by:

Phone:

Date: 05/12/2022

Qty.	Description																
1	<table><tr><td>Cos phi:</td><td>0.64</td></tr><tr><td>Enclosure class (IEC 34-5):</td><td>X4D</td></tr><tr><td>Insulation class (IEC 85):</td><td>F</td></tr><tr><td>Winding resistance:</td><td>83.5 - 110.0 ohm</td></tr><tr><td colspan="2">Others:</td></tr><tr><td>Net weight:</td><td>35.9 lb</td></tr><tr><td>Gross weight:</td><td>43.4 lb</td></tr><tr><td>Shipping volume:</td><td>2.08 ft³</td></tr></table>	Cos phi:	0.64	Enclosure class (IEC 34-5):	X4D	Insulation class (IEC 85):	F	Winding resistance:	83.5 - 110.0 ohm	Others:		Net weight:	35.9 lb	Gross weight:	43.4 lb	Shipping volume:	2.08 ft ³
Cos phi:	0.64																
Enclosure class (IEC 34-5):	X4D																
Insulation class (IEC 85):	F																
Winding resistance:	83.5 - 110.0 ohm																
Others:																	
Net weight:	35.9 lb																
Gross weight:	43.4 lb																
Shipping volume:	2.08 ft ³																

96402711 UPS 32-80 F 60 Hz

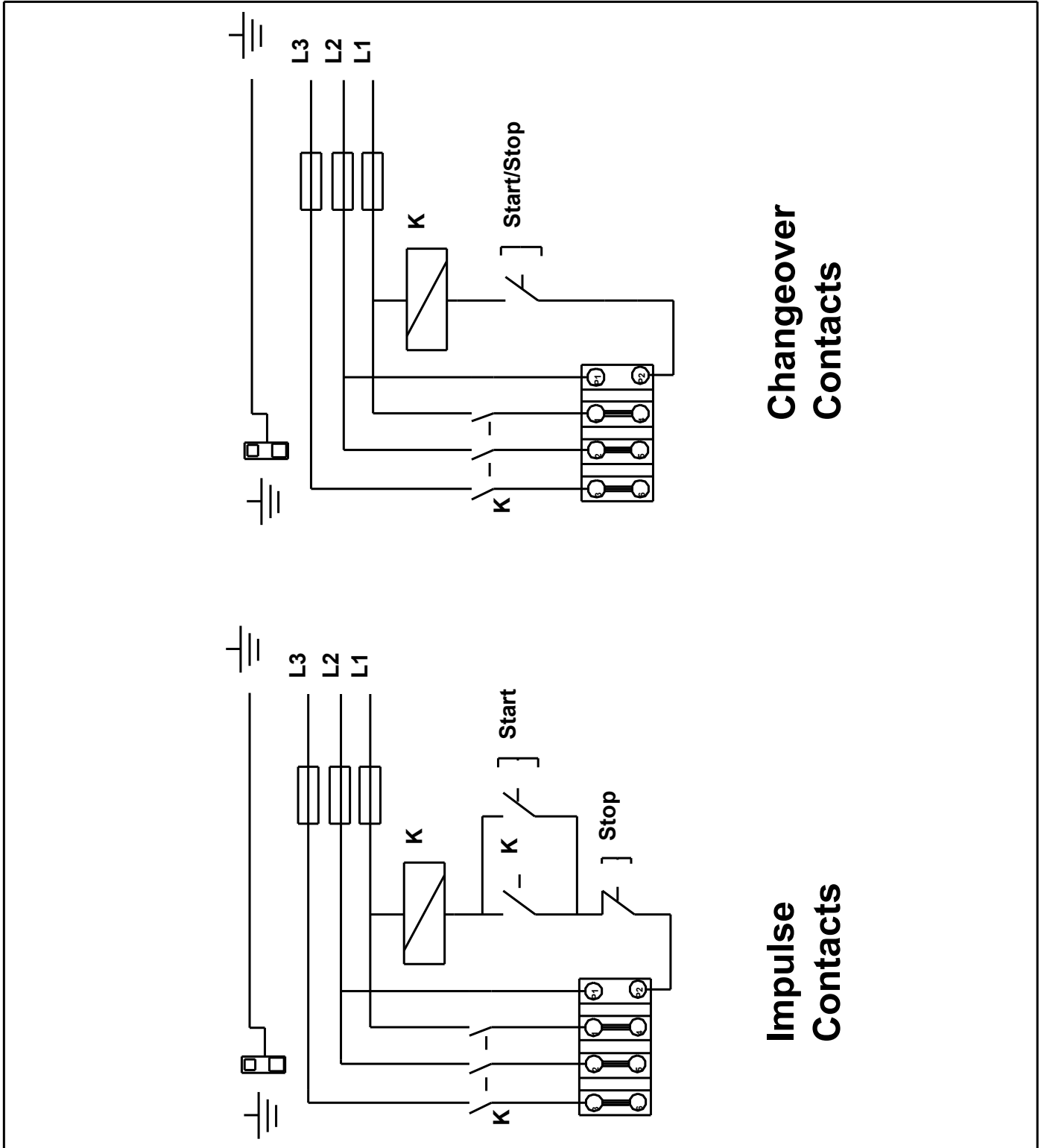

**Changeover
Contacts**

**Impulse
Contacts**

Note! All units are in [in] unless others are stated.