

PROJECT: _____	UNIT TAG: _____	QUANTITY: _____
REPRESENTATIVE: _____	TYPE OF SERVICE: _____	DATE: _____
ENGINEER: _____	SUBMITTED BY: _____	DATE: _____
CONTRACTOR: _____	APPROVED BY: _____	DATE: _____
	ORDER NO.: _____	DATE: _____



## NBSE 020-110/9.92 AASG6S2ESBQQEMCA

Split-coupled End-suction pumps with NEMA MLE motors and ANSI flange fittings.

Note! Product picture may differ from actual product

Conditions of Service		Pump Data		Motor Data	
Efficiency:	%	Liquid temperature range:	-13 .. 248 °F	Rated voltage:	440-480 V
Liquid:	Water	Maximum ambient temperature:	122 °F	Mains frequency:	60 Hz
Temperature:	68 °F	Shaft seal:	BQQE	Enclosure class:	TEFC
NPSH required:	ft	Product number:	On request	Enclosure class:	IP55
Specific Gravity:	1.000			Insulation class:	F
				Motor protection:	ELEC
				Motor type:	132H
				Eta 1/1:	93.6 %

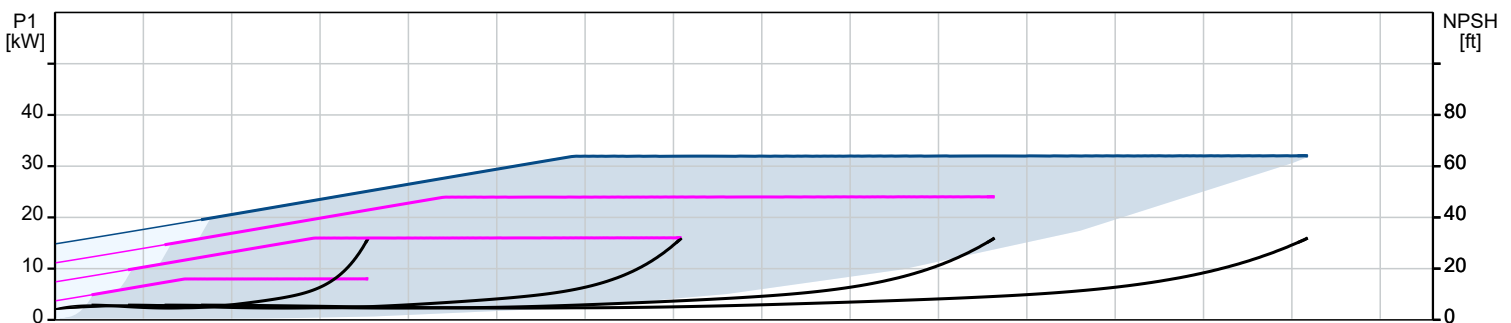
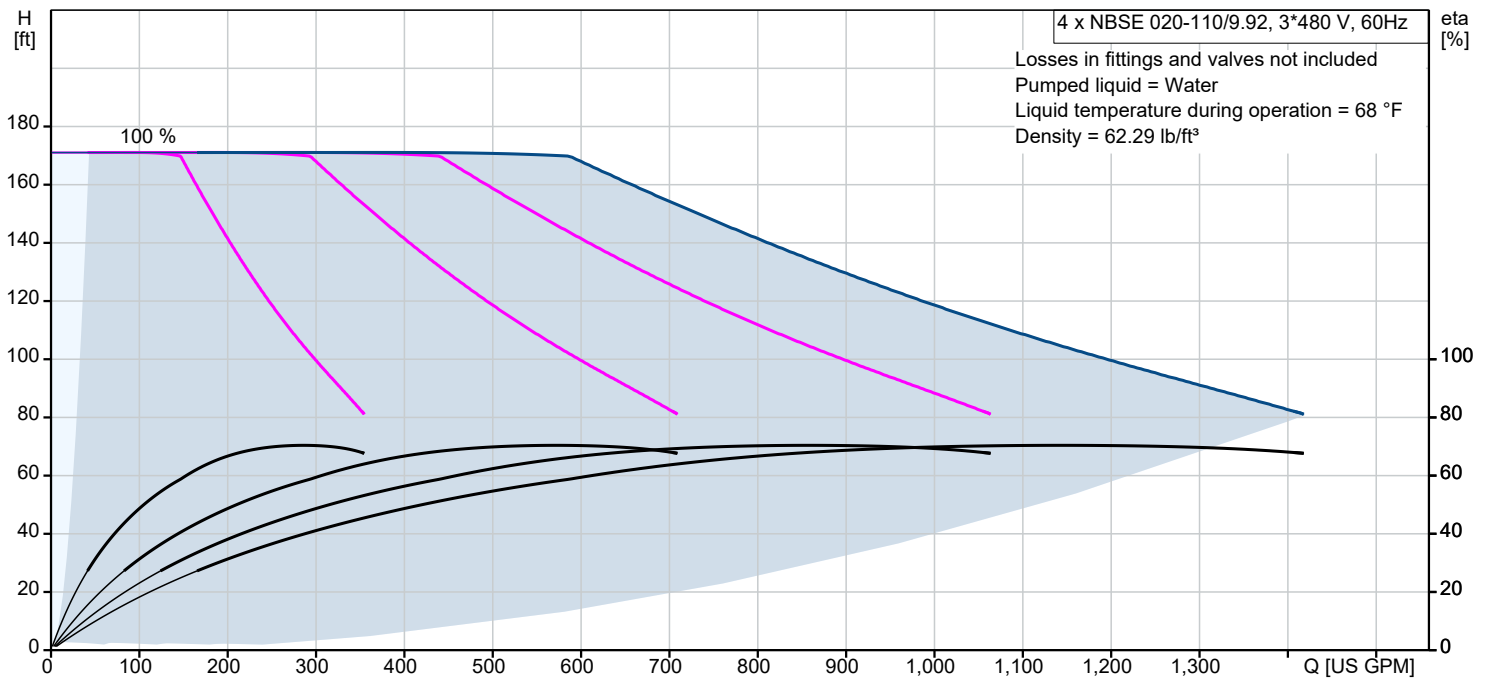

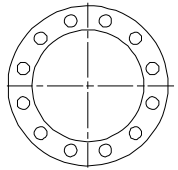
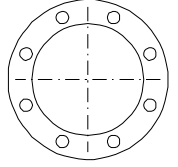
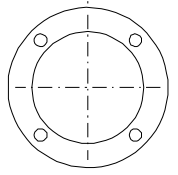
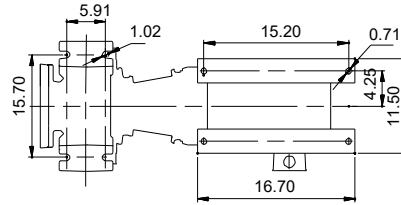
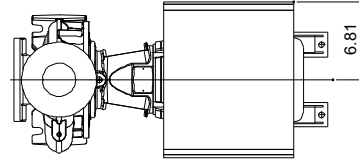
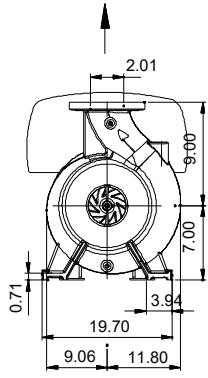
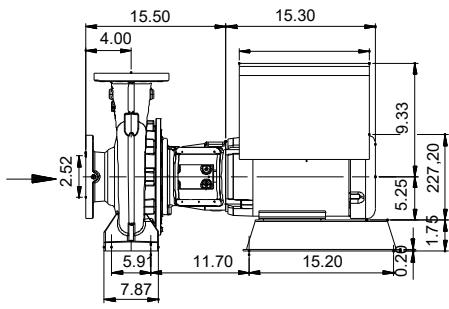

**Materials:**

- Pump housing: Cast iron
- Pump housing: ASTM A48-35
- Impeller: Stainless steel
- Impeller: AISI 304
- Impeller: EN 1.4308
- Material code: S2
- Code for rubber: E

Description	Value
<b>General information:</b>	
Product name:	NBSE 020-110/9.92 AASG6S2ESBQQEMCA
Product No:	On request
EAN number:	On request
<b>Technical:</b>	
Pump speed on which pump data are based:	2200 rpm
Rated flow:	290 US GPM
Rated head:	103.3 ft
Actual impeller diameter:	9.92 in
Code for shaft seal:	BQQE
Curve tolerance:	2B HI 14.6:2016
Pump version:	AS
<b>Materials:</b>	
Pump housing:	Cast iron
Pump housing:	EN-GJL-250
Pump housing:	ASTM A48-35
Impeller:	Stainless steel
Impeller:	EN 1.4308
Impeller:	AISI 304
Internal pump house coating:	No coating
Material code:	S2
Code for rubber:	E
Shaft:	Stainless steel
Shaft:	EN 1.4201/1.4034
Shaft:	AISI 420
<b>Installation:</b>	
Maximum ambient temperature:	122 °F
Maximum operating pressure:	174.05 psi
Type of connection:	ANSI
Size of inlet connection:	2.5 inch
Size of outlet connection:	2 inch
Pressure rating for connection:	Class 125
Mounting options design code:	B
Support block (Yes/No):	Y
Connect code:	G
<b>Liquid:</b>	
Pumped liquid:	Water
Liquid temperature range:	-13 .. 248 °F
Selected liquid temperature:	68 °F
Density:	62.29 lb/ft³
<b>Electrical data:</b>	
Motor standard:	NEMA
Motor type:	132H
IE efficiency class:	IE5
Rated power - P2:	10 HP
Mains frequency:	60 Hz
Rated voltage:	3 x 440-480 V
Rated current:	12.2-11.3 A
Cos phi - power factor:	0.91-0.90
Rated speed:	180-2200 rpm
Motor efficiency at full load:	93.6 %
Number of poles:	4
Enclosure class (IEC 34-5):	IP55
Insulation class (IEC 85):	F
Built-in motor protection:	ELEC
Motor No:	99198235
Mounting designation (IEC 34-7, Code I):	NEMA type C / foot
Bearing insulation type N-end:	STEEL BEARING
<b>Controls:</b>	
Control panel:	HMI300 - Advanced
Function Module:	FM300 - Advanced

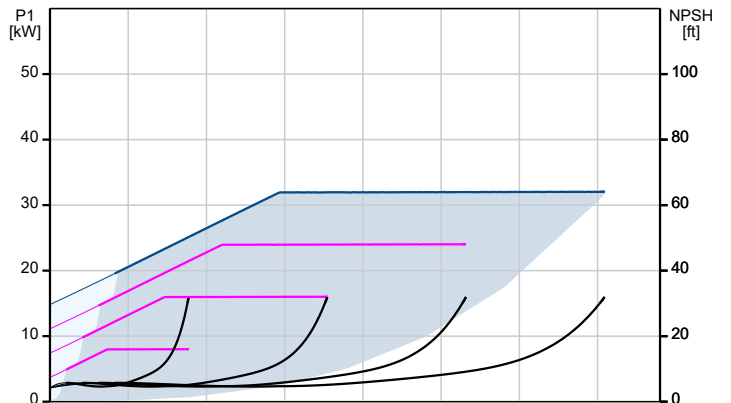
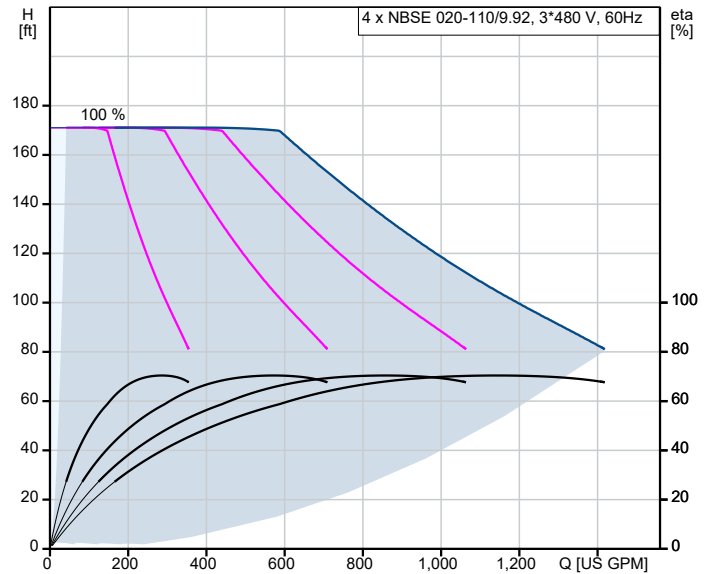



Company name:

Created by:

Phone:

Date:

05/10/2023

Description	Value
<b>Others:</b>	
DOE Pump Energy Index CL:	0.00
DOE Pump Energy Index VL:	0.40
Net weight:	281 lb
Gross weight:	282 lb
Shipping volume:	9.43 ft <sup>3</sup>