

PROJECT: _____	UNIT TAG: _____	QUANTITY: _____
REPRESENTATIVE: _____	TYPE OF SERVICE: _____	DATE: _____
ENGINEER: _____	SUBMITTED BY: _____	DATE: _____
CONTRACTOR: _____	APPROVED BY: _____	DATE: _____
	ORDER NO.: _____	DATE: _____



NBSE 030-070/6.85 AASG6S2ESBQQEKCA

Split-coupled End-suction pumps with NEMA MLE motors and ANSI flange fittings.

Note! Product picture may differ from actual product

Conditions of Service		Pump Data		Motor Data	
Efficiency:	%	Liquid temperature range:	-13 .. 248 °F	Rated voltage:	440-480 V
Liquid:	Water	Maximum ambient temperature:	122 °F	Mains frequency:	60 Hz
Temperature:	68 °F	Shaft seal:	BQQE	Enclosure class:	TEFC
NPSH required:	ft	Product number:	On request	Enclosure class:	IP55
Specific Gravity:	1.000			Insulation class:	F
				Motor protection:	ELEC
				Motor type:	112E
				Eta 1/1:	92.2 %

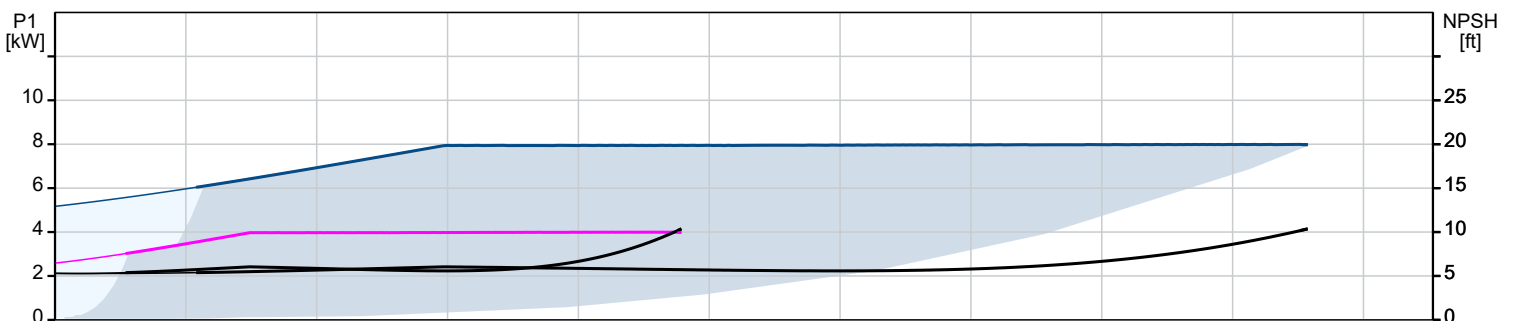
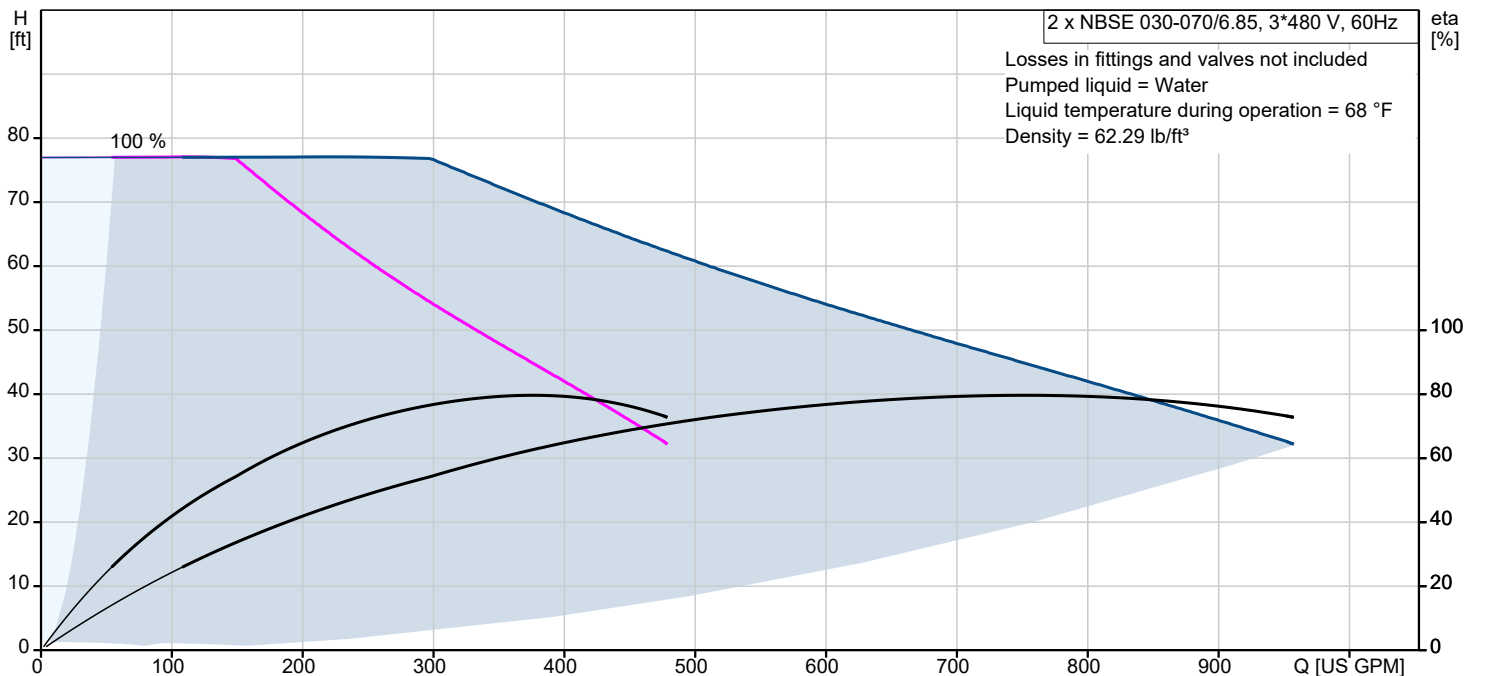

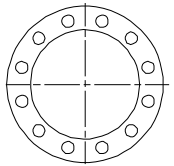
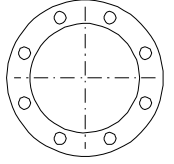
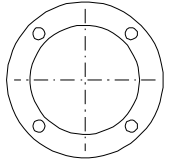
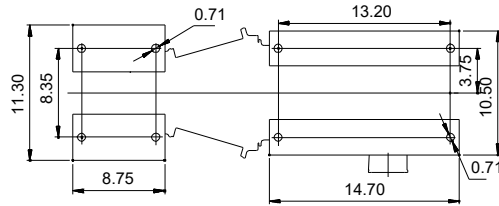
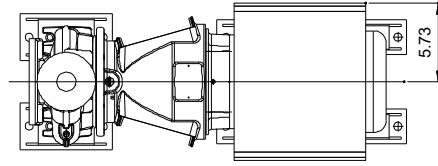
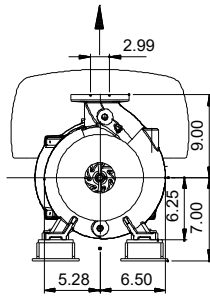
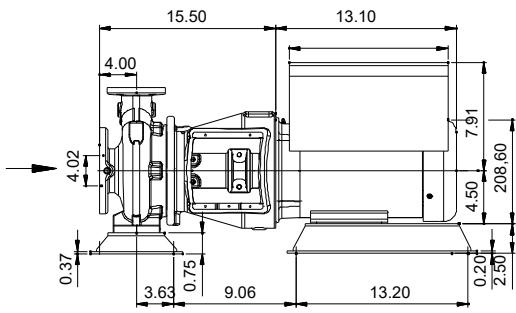

Materials:

- Pump housing: Cast iron
- Pump housing: ASTM A48-35
- Impeller: Stainless steel
- Impeller: AISI 304
- Impeller: EN 1.4308
- Material code: S2
- Code for rubber: E

Description	Value
General information:	
Product name:	NBSE 030-070/6.85 AASG6S2ESBQQEKCA
Product No:	On request
EAN number:	On request
Technical:	
Pump speed on which pump data are based:	2200 rpm
Rated flow:	377 US GPM
Rated head:	44.78 ft
Actual impeller diameter:	6.85 in
Code for shaft seal:	BQQE
Curve tolerance:	2B HI 14.6:2016
Pump version:	AS
Materials:	
Pump housing:	Cast iron
Pump housing:	EN-GJL-250
Pump housing:	ASTM A48-35
Impeller:	Stainless steel
Impeller:	EN 1.4308
Impeller:	AISI 304
Internal pump house coating:	No coating
Material code:	S2
Code for rubber:	E
Shaft:	Stainless steel
Shaft:	EN 1.4201/1.4034
Shaft:	AISI 420
Installation:	
Maximum ambient temperature:	122 °F
Maximum operating pressure:	174.05 psi
Type of connection:	ANSI
Size of inlet connection:	4 inch
Size of outlet connection:	3 inch
Pressure rating for connection:	Class 125
Mounting options design code:	C
Support block (Yes/No):	Y
Connect code:	G
Liquid:	
Pumped liquid:	Water
Liquid temperature range:	-13 .. 248 °F
Selected liquid temperature:	68 °F
Density:	62.29 lb/ft³
Electrical data:	
Motor standard:	NEMA
Motor type:	112E
IE efficiency class:	IE5
Rated power - P2:	5 HP
Mains frequency:	60 Hz
Rated voltage:	3 x 440-480 V
Rated current:	6.20-5.80 A
Cos phi - power factor:	0.90-0.88
Rated speed:	180-2200 rpm
Motor efficiency at full load:	92.2 %
Number of poles:	4
Enclosure class (IEC 34-5):	IP55
Insulation class (IEC 85):	F
Built-in motor protection:	ELEC
Motor No:	99198232
Mounting designation (IEC 34-7, Code I):	NEMA type C / foot
Bearing insulation type N-end:	STEEL BEARING
Controls:	
Control panel:	HMI300 - Advanced
Function Module:	FM300 - Advanced

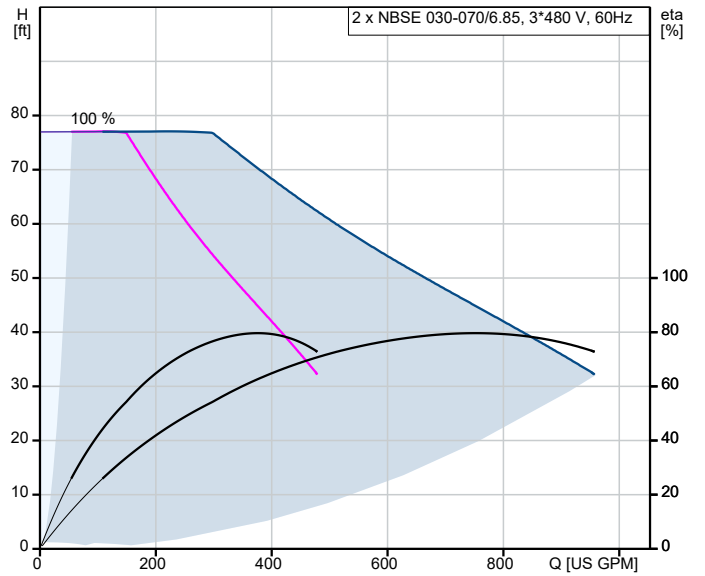

Losses in fittings and valves not included
 Pumped liquid = Water
 Liquid temperature during operation = 68 °F
 Density = 62.29 lb/ft³

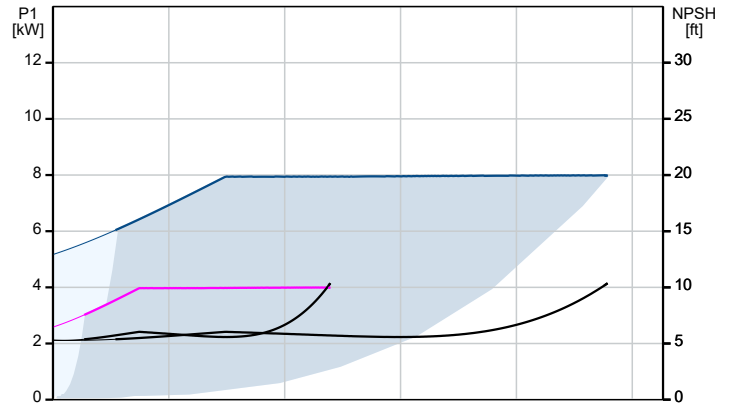



Company name:

Created by:

Phone:

Date:

05/10/2023

Description	Value
Others:	
DOE Pump Energy Index CL:	0.00
DOE Pump Energy Index VL:	0.41
Net weight:	236 lb
Gross weight:	237 lb
Shipping volume:	5.54 ft ³