

| | | |
|-----------------------|------------------------|-----------------|
| PROJECT: _____ | UNIT TAG: _____ | QUANTITY: _____ |
| REPRESENTATIVE: _____ | TYPE OF SERVICE: _____ | DATE: _____ |
| ENGINEER: _____ | SUBMITTED BY: _____ | DATE: _____ |
| CONTRACTOR: _____ | APPROVED BY: _____ | DATE: _____ |
| | ORDER NO.: _____ | DATE: _____ |



NBSE 050-095/6.85-6.06 AASG6S2ESBQQEMCA

Split-coupled End-suction pumps with NEMA MLE motors and ANSI flange fittings.

Note! Product picture may differ from actual product

| Conditions of Service | | Pump Data | | Motor Data | |
|-----------------------|-------|------------------------------|---------------|-------------------|-----------|
| Efficiency: | % | Liquid temperature range: | -13 .. 248 °F | Rated voltage: | 440-480 V |
| Liquid: | Water | Maximum ambient temperature: | 122 °F | Mains frequency: | 60 Hz |
| Temperature: | 68 °F | Shaft seal: | BQQE | Enclosure class: | TEFC |
| NPSH required: | ft | Product number: | On request | Enclosure class: | IP55 |
| Specific Gravity: | 1.000 | | | Insulation class: | F |
| | | | | Motor protection: | ELEC |
| | | | | Motor type: | 132H |
| | | | | Eta 1/1: | 93.6 % |

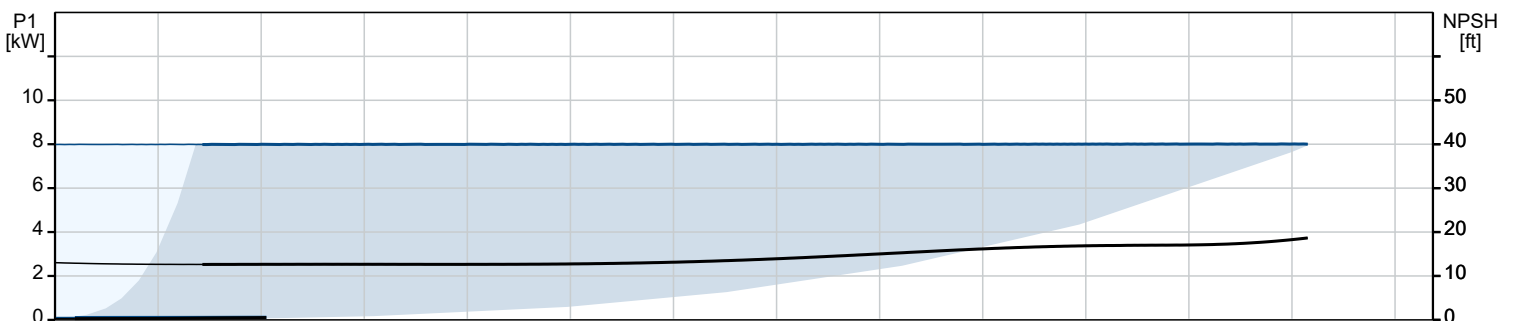
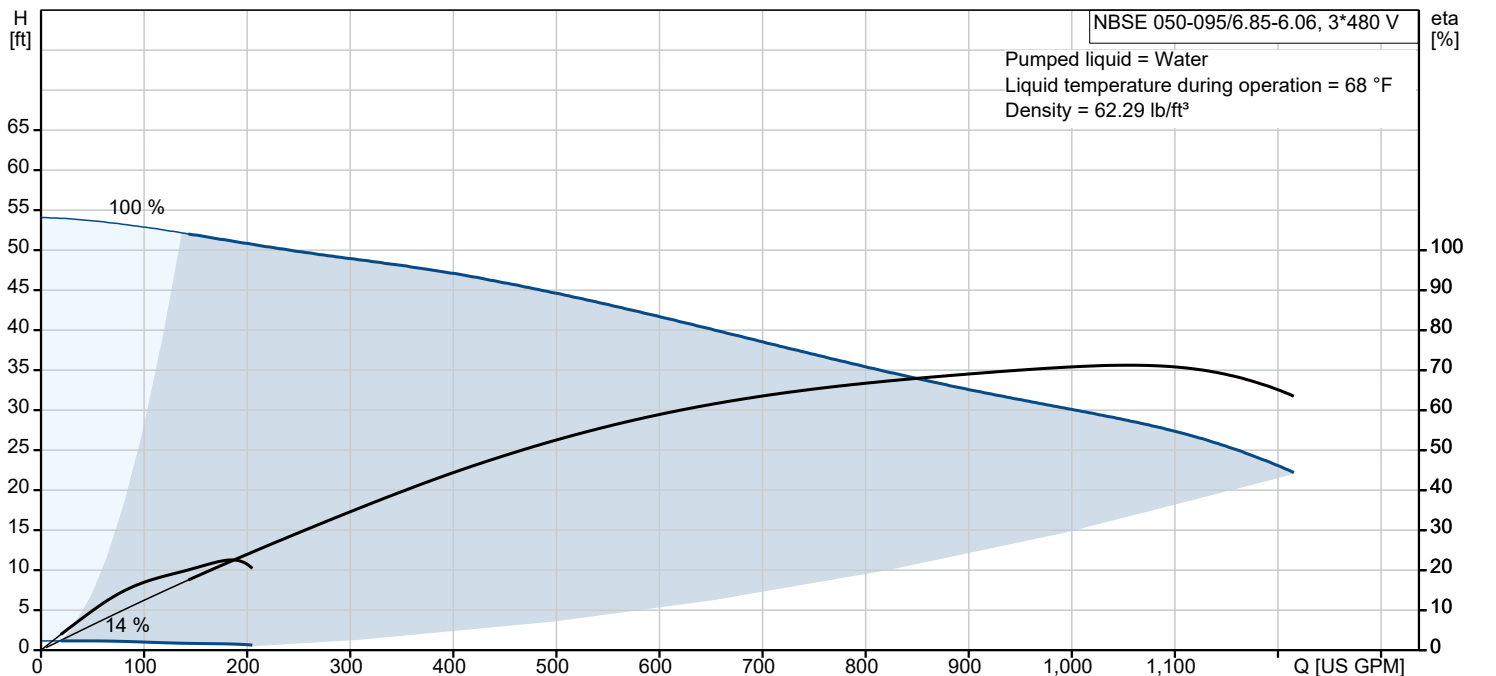

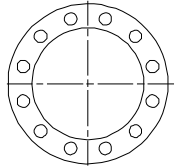
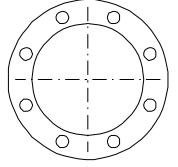
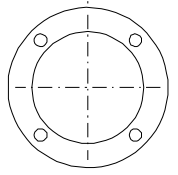
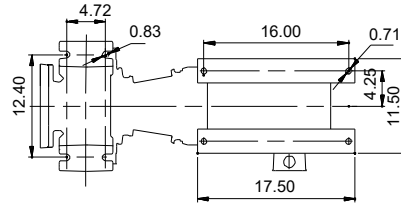
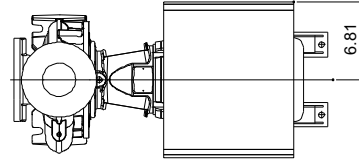
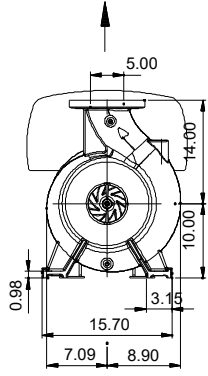
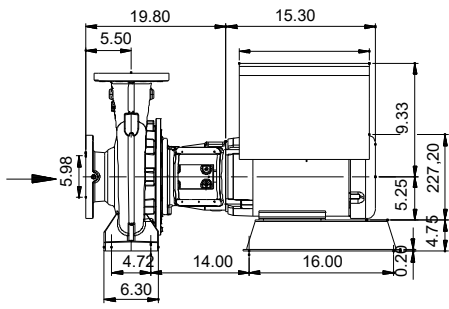

Materials:

- Pump housing: Cast iron
- Pump housing: ASTM A48-35
- Impeller: Stainless steel
- Impeller: AISI 304
- Impeller: EN 1.4308
- Material code: S2
- Code for rubber: E

| Description | Value |
|--|--|
| General information: | |
| Product name: | NBSE 050-095/6.85-6.06 AASG6S2ESBQQEMCA |
| Product No: | On request |
| EAN number: | On request |
| Technical: | |
| Pump speed on which pump data are based: | 2200 rpm |
| Rated flow: | 1060 US GPM |
| Rated head: | 28.7 ft |
| Actual impeller diameter: | 6.46 in |
| Code for shaft seal: | BQQE |
| Curve tolerance: | 2B HI 14.6:2016 |
| Pump version: | AS |
| Materials: | |
| Pump housing: | Cast iron |
| Pump housing: | EN-GJL-250 |
| Pump housing: | ASTM A48-35 |
| Impeller: | Stainless steel |
| Impeller: | EN 1.4308 |
| Impeller: | AISI 304 |
| Internal pump house coating: | No coating |
| Material code: | S2 |
| Code for rubber: | E |
| Shaft: | Stainless steel |
| Shaft: | EN 1.4201/1.4034 |
| Shaft: | AISI 420 |
| Installation: | |
| Maximum ambient temperature: | 122 °F |
| Maximum operating pressure: | 174.05 psi |
| Type of connection: | ANSI |
| Size of inlet connection: | 6 inch |
| Size of outlet connection: | 5 inch |
| Pressure rating for connection: | Class 125 |
| Mounting options design code: | B |
| Support block (Yes/No): | Y |
| Connect code: | G |
| Liquid: | |
| Pumped liquid: | Water |
| Liquid temperature range: | -13 .. 248 °F |
| Selected liquid temperature: | 68 °F |
| Density: | 62.29 lb/ft³ |
| Electrical data: | |
| Motor standard: | NEMA |
| Motor type: | 132H |
| IE efficiency class: | IE5 |
| Rated power - P2: | 10 HP |
| Mains frequency: | 60 Hz |
| Rated voltage: | 3 x 440-480 V |
| Rated current: | 12.2-11.3 A |
| Cos phi - power factor: | 0.91-0.90 |
| Rated speed: | 180-2200 rpm |
| Motor efficiency at full load: | 93.6 % |
| Number of poles: | 4 |
| Enclosure class (IEC 34-5): | IP55 |
| Insulation class (IEC 85): | F |
| Built-in motor protection: | ELEC |
| Motor No: | 99198235 |
| Mounting designation (IEC 34-7, Code I): | NEMA type C / foot |
| Bearing insulation type N-end: | STEEL BEARING |
| Controls: | |
| Control panel: | HMI300 - Advanced |
| Function Module: | FM300 - Advanced |

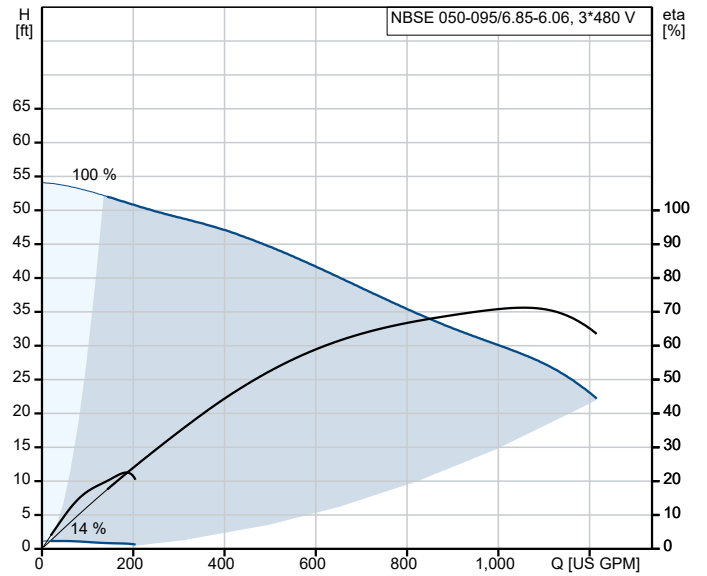

Pumped liquid = Water
 Liquid temperature during operation = 68 °F
 Density = 62.29 lb/ft³

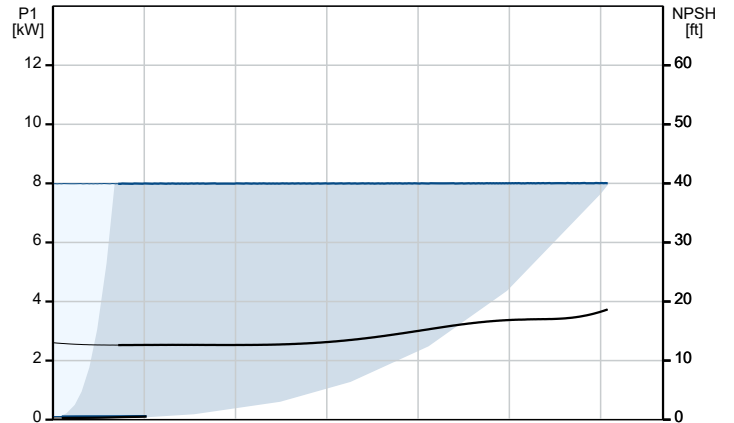



Company name: GoGrundfos.com

Created by:

Phone:

Date: 05/10/2023

| Description | Value |
|---------------------------|----------------------|
| Others: | |
| DOE Pump Energy Index CL: | 0.00 |
| DOE Pump Energy Index VL: | 0.46 |
| Net weight: | 420 lb |
| Gross weight: | 421 lb |
| Shipping volume: | 12.1 ft ³ |
| Country of origin: | US |