

Pump Performance Datasheet

Customer :	Quote Number / ID : 1471203
Customer ref. / PO :	Model : NBS 030-135-4P
Tag Number : 001	Stages : 1
Service :	Based on curve number : 030-135-4P_Std
Quantity : 1	Basic model number : -
	Date last saved : 10/11/2022 3:35 PM

Operating Conditions	Liquid
Flow, rated : 605.7 USgpm	Liquid type : Cold Water
Differential head / pressure, rated (requested) : 128.2 ft	Additional liquid description :
Differential head / pressure, rated (actual) : 128.2 ft	Solids diameter, max : 0.00 in
Suction pressure, rated / max : 0.00 / 0.00 psi.g	Solids concentration, by volume : 0.00 %
NPSH available, rated : Ample	Temperature, max : 68.00 deg F
Site Supply Frequency : 60 Hz	Fluid density, rated / max : 1.000 / 1.000 SG
	Viscosity, rated : 1.00 cP
	Vapor pressure, rated : 0.34 psi.a

Performance	Material
Speed, rated : 1765 rpm	Material selected : Cast iron / 125 Class
Impeller diameter, rated : 11.26 in	
Impeller diameter, maximum : 12.91 in	
Impeller diameter, minimum : 8.98 in	
Efficiency : 77.67 %	

Performance	Pressure Data
NPSH required / margin required : 12.80 / 0.00 ft	Maximum working pressure : 63.92 psi.g
nq (imp. eye flow) / S (imp. eye flow) : 20 / 104 Metric units	Maximum allowable working pressure : 175.0 psi.g
MCSF : 54.89 USgpm	Maximum allowable suction pressure : 130.0 psi.g
Head, maximum, rated diameter : 147.7 ft	Hydrostatic test pressure : 263.0 psi.g
Head rise to shutoff : 15.17 %	
Flow, best eff. point : 605.7 USgpm	
Flow ratio, rated / BEP : 100.00 %	
Diameter ratio (rated / max) : 87.22 %	
Head ratio (rated dia / max dia) : 74.96 %	
Cq/Ch/Ce/Cn [ANSI/HI 9.6.7-2010] : 1.00 / 1.00 / 1.00 / 1.00	
Selection status : Acceptable	

Performance	Driver & Power Data (@Max density)
Head, maximum, rated diameter : 147.7 ft	Motor sizing specification : Max power (non-overloading)
Head rise to shutoff : 15.17 %	Margin over specification : 0.00 %
Flow, best eff. point : 605.7 USgpm	Service factor : 1.15 (used)
Flow ratio, rated / BEP : 100.00 %	Power, hydraulic : 19.61 hp
Diameter ratio (rated / max) : 87.22 %	Rated power (based on duty point) : 25.25 hp
Head ratio (rated dia / max dia) : 74.96 %	Max power (non-overloading) : 29.33 hp
Cq/Ch/Ce/Cn [ANSI/HI 9.6.7-2010] : 1.00 / 1.00 / 1.00 / 1.00	Nameplate motor rating : 30.00 hp / 22.37 kW
Selection status : Acceptable	

Energy Indexes
PEI (CL) : 0.91
ER (CL) : 9

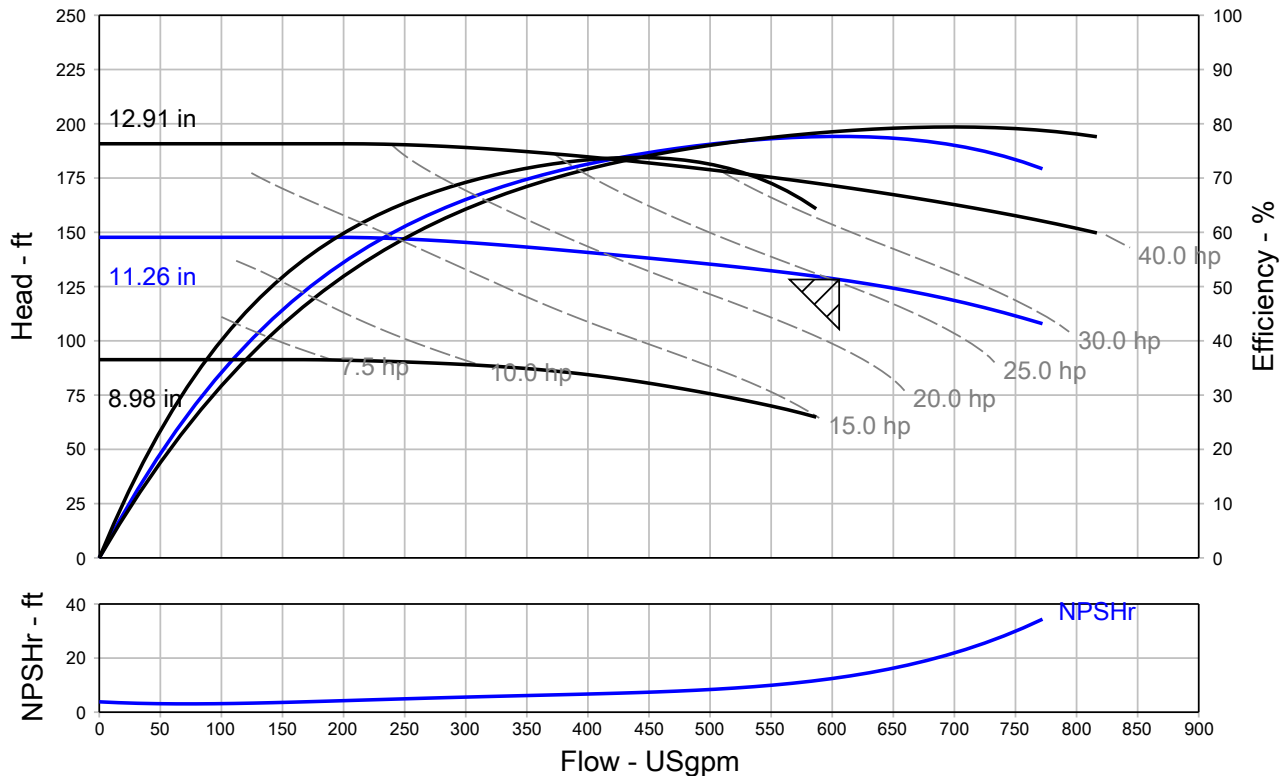

Grundfos Series NBS - Split Coupled End Suction Pump

QUOTE NUMBER / ID 1471203	UNIT TAG 001	QUANTITY 1
REPRESENTATIVE	SERVICE	
ENGINEER	SUBMITTED BY	DATE
CONTRACTOR	APPROVED BY	DATE
	ORDER #	DATE



NBS 030-135-4P
1765 rpm

Conditions of Service		Pump Data		Motor Data	
Flow	605.7 USgpm	Impeller Diameter	11.26 in	Motor HP	30 HP
Head	128.2 ft	Max. Imp. Dia.	12.91 in	BHP	25.25 HP
Liquid	Cold Water	Min. Imp. Dia.	8.98 in	Enclosure	TEFC
Temperature	68.00 deg F	Efficiency	77.67 %	Voltage	230/460 V
NPSHr	12.80 ft	Suction	4 in	Phase	3 Phase
Viscosity	1.00 cP	Discharge	3 in	Cycle	60
Specific Gravity	1.000 SG	PEI (CL)	0.91	Frame Size	286TC
		ER (CL)	9	Shaft Grounding	Include

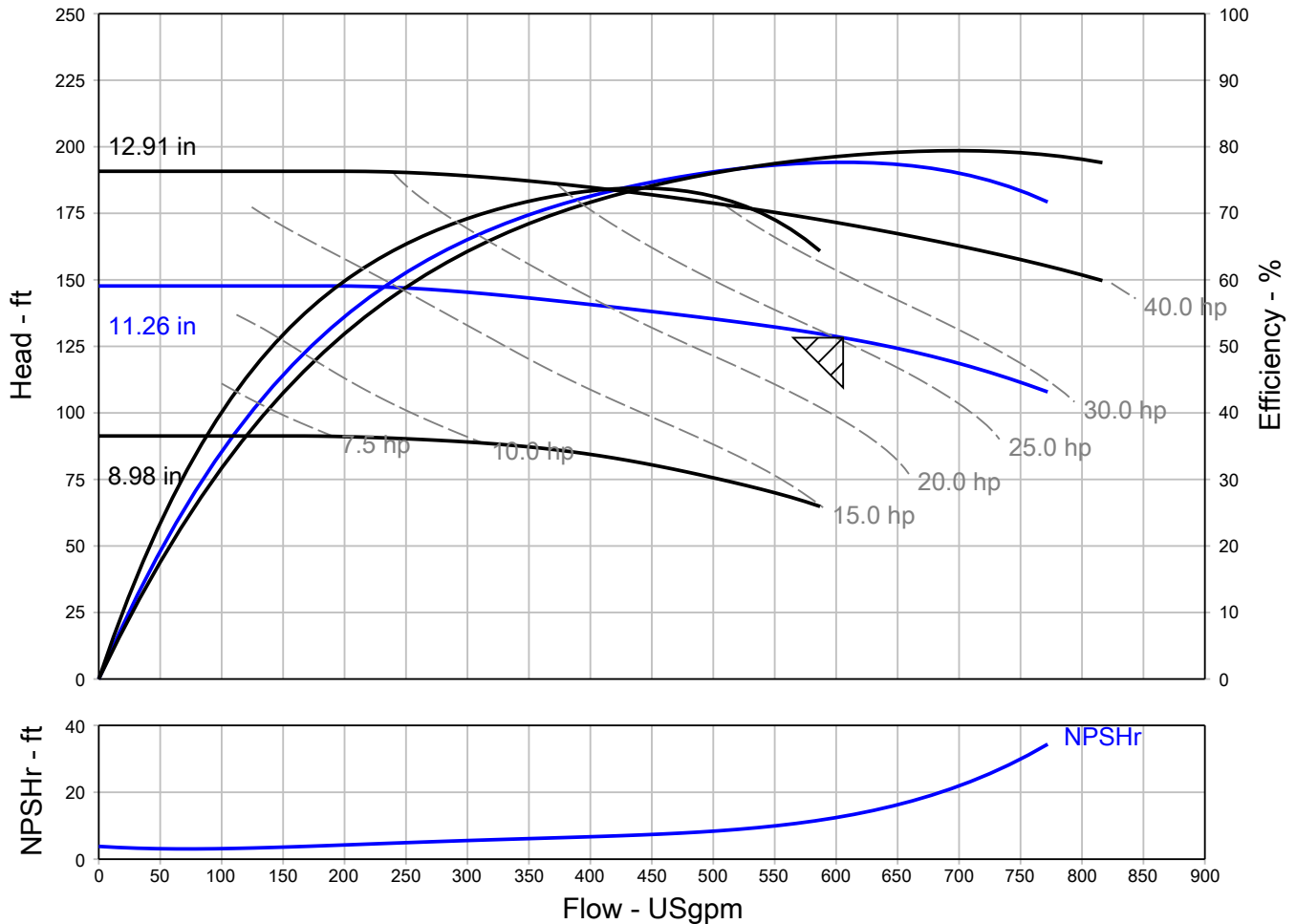

Grundfos Series NBS - Split Coupled End Suction Pump

Mounting design B
Centre-line outlet
Motor with support rails

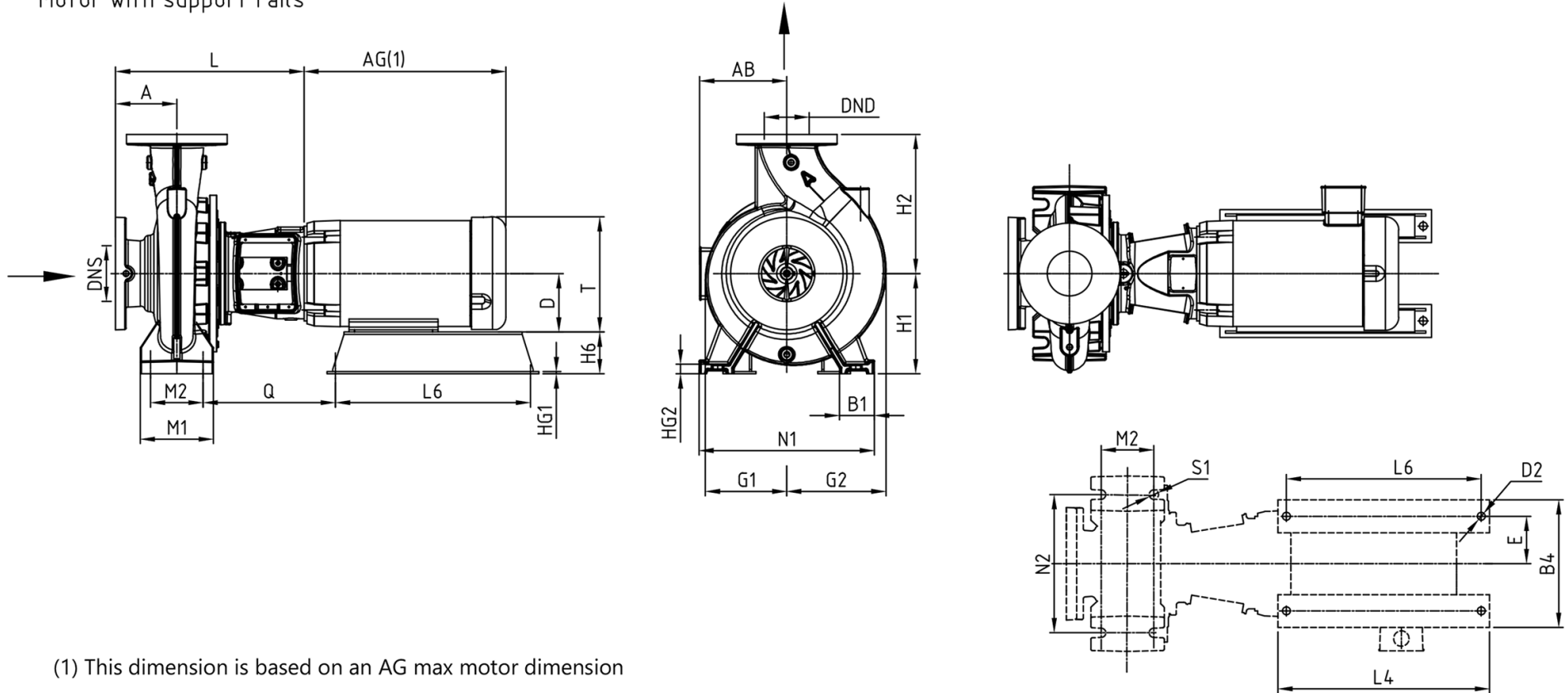

NOT FOR CONSTRUCTION, unless certified and referenced on order

Units	Frame	DNS	DND	Class	A	AB	AG	B1	B4	D	D2	E	G1	G2	H1	H2	H6	HG1	HG2	L	L4	L6	M1	M2	N1	N2	Q	S1	T
inches	286TC	4	3	125	5.00	13.13	23.63	2.99	15.17	7.00	0.69	5.50	8.19	9.39	10.00	12.50	3.00	0.31	0.55	18.94	22.25	20.75	6.30	4.72	15.75	12.40	14.57	0.83	14.63