

PROJECT: _____	UNIT TAG: _____	QUANTITY: _____
REPRESENTATIVE: _____	TYPE OF SERVICE: _____	DATE: _____
ENGINEER: _____	SUBMITTED BY: _____	DATE: _____
CONTRACTOR: _____	APPROVED BY: _____	DATE: _____
	ORDER NO.: _____	DATE: _____

SL1.30.A40 .75.EX.4.61R.C



Submersible Grundfos SL sewage pumps (1.1-11 kW) are fitted with an S-tube® impeller. The free passage through the pump varies from 50-100 mm depending on size.

Note! Product picture may differ from actual product

Conditions of Service	Pump Data	Motor Data
Specific Gravity: 1.000	Liquid temperature range: 50 .. 104 °F Maximum ambient temperature: 104 °F Approvals: CSA, FM Flange standard: ANSI Product number: 99030145	Mains frequency: 60 Hz Number of poles: 4 Enclosure class: IP68 Motor protection: THERMAL SWITCH Eta 1/1: 88.9 %

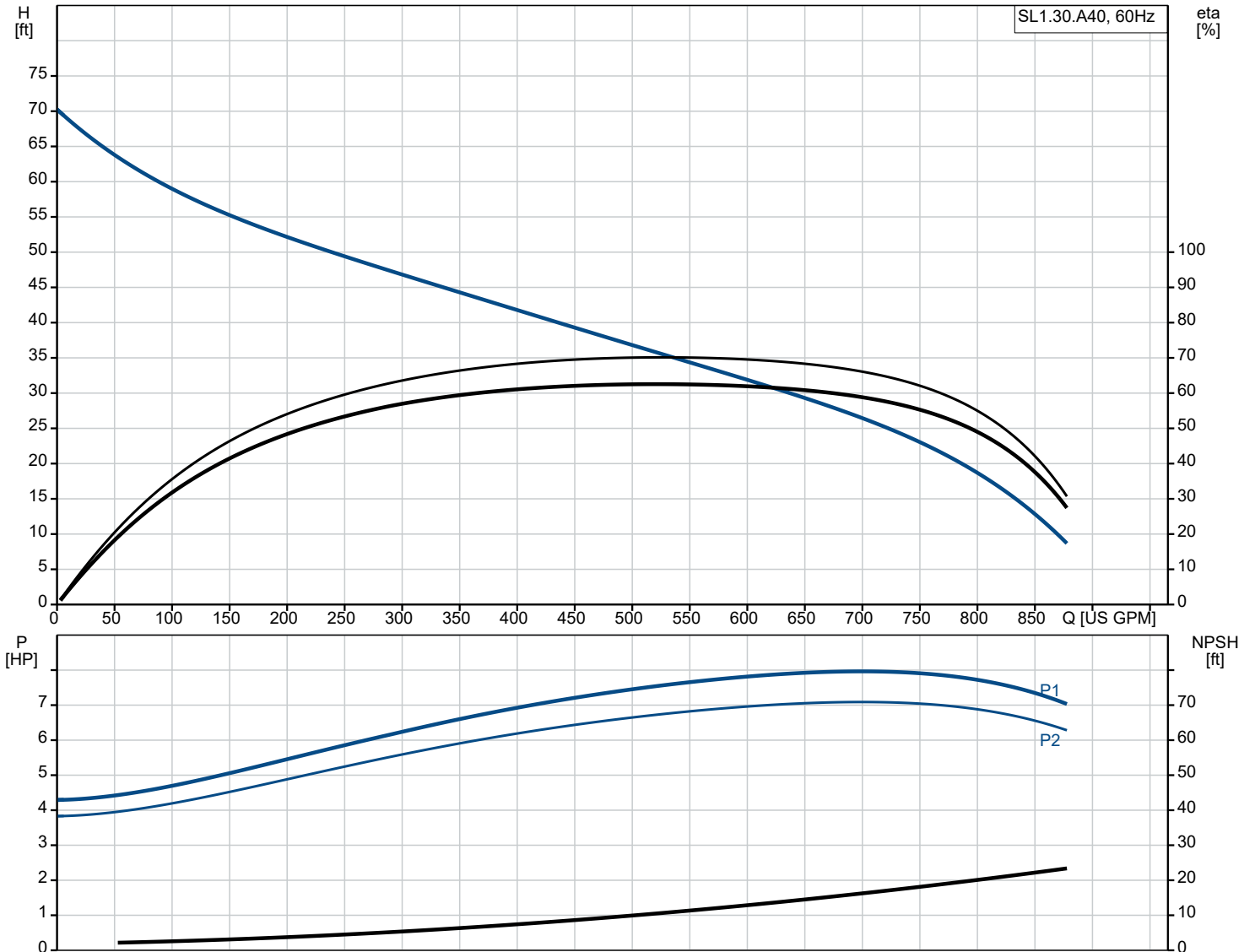

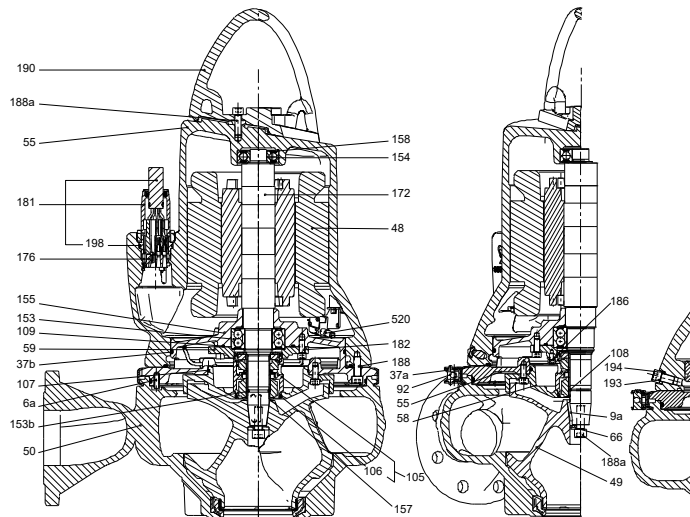
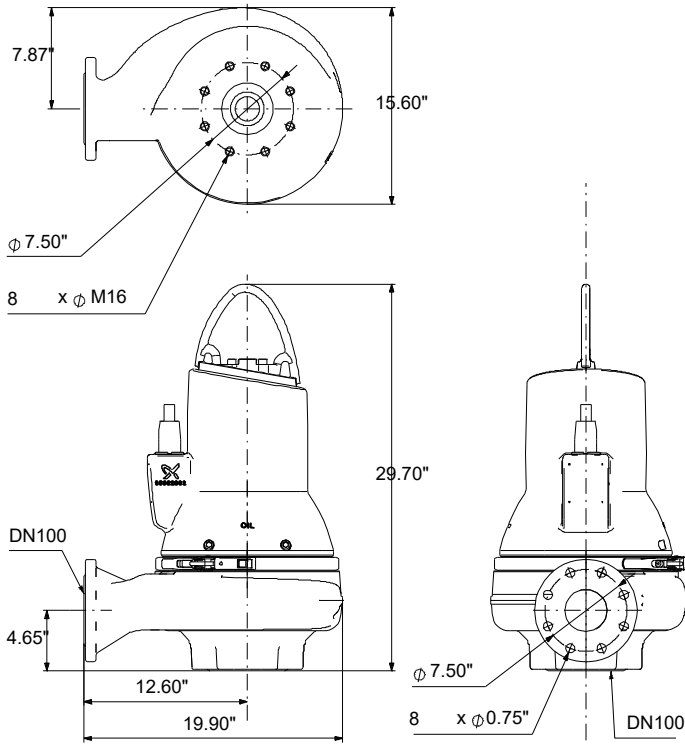

Materials:

- Pump housing: Cast iron
- Pump housing: EN 5.1301 EN-GJL-250
- Pump housing: ASTM ASTM A48-250B
- Impeller: Cast iron
- Impeller: ASTM A48-250B
- Impeller: EN 5.1301 EN-GJL-250
- Motor: EN-GJL-250

Description	Value
General information:	
Product name:	SL1.30.A40 .75.EX.4.61R.C
Product No:	99030145
EAN number:	5712605415664
Technical:	
Maximum flow:	881 US GPM
Maximum head:	70.21 ft
Type of impeller:	S-TUBE
Maximum particle size:	3 1/8 in
Primary shaft seal:	SIC/SIC
Approvals on nameplate:	CSA, FM
Curve tolerance:	ANSI/HI11.6:2017 3B2
Cooling jacket:	without cooling jacket
Rated speed:	1750 rpm
Materials:	
Pump housing:	Cast iron
Pump housing:	EN 5.1301 EN-GJL-250
Pump housing:	ASTM ASTM A48-250B
Impeller:	Cast iron
Impeller:	EN 5.1301 EN-GJL-250
Impeller:	ASTM A48-250B
Motor:	EN-GJL-250
Installation:	
Range of ambient temperature:	-4 .. 104 °F
Maximum operating pressure:	87.02 psi
Flange standard:	ANSI
Type of inlet connection:	ANSI
Type of outlet connection:	ANSI
Size of inlet connection:	DN 100
Size of outlet connection:	DN 100
Pressure rating:	PN 10
Maximum installation depth:	65.6 ft
Inst dry/wet:	SUBMERGED
Installation:	Vertical
Auto-coupling:	97626238
Frame range:	C
Liquid:	
Liquid temperature range:	50 .. 104 °F
Density:	62.29 lb/ft ³
Electrical data:	
Power input - P1:	6.4 kW
Rated power - P2:	7.5 HP
Mains frequency:	60 Hz
Rated voltage [V]:	3 x 460 V
Voltage tolerance:	+10/-10 %
Max starts per. hour:	20
Rated current:	19.2/10.1 A
Starting current:	120 A
Cos phi - power factor:	0.87
Cos phi - p.f. at 3/4 load:	0.84
Cos phi - p.f. at 1/2 load:	0.77
Rated speed:	1750 rpm
Motor efficiency at full load:	88.9 %
Motor efficiency at 3/4 load:	89.65 %
Motor efficiency at 1/2 load:	89.2 %
Number of poles:	4
Start. method:	star/delta
Enclosure class (IEC 34-5):	IP68
Insulation class (IEC 85):	H
Explosion proof:	yes
Built-in motor protection:	THERMAL SWITCH
Length of power cable:	49.2 ft
Cable type:	SEOOW 600V
Controls:	
Control box:	not included
Moisture sensor:	with moisture sensors
Water-in-oil sensor:	without water-in-oil sensor
Others:	
Net weight:	350 lb

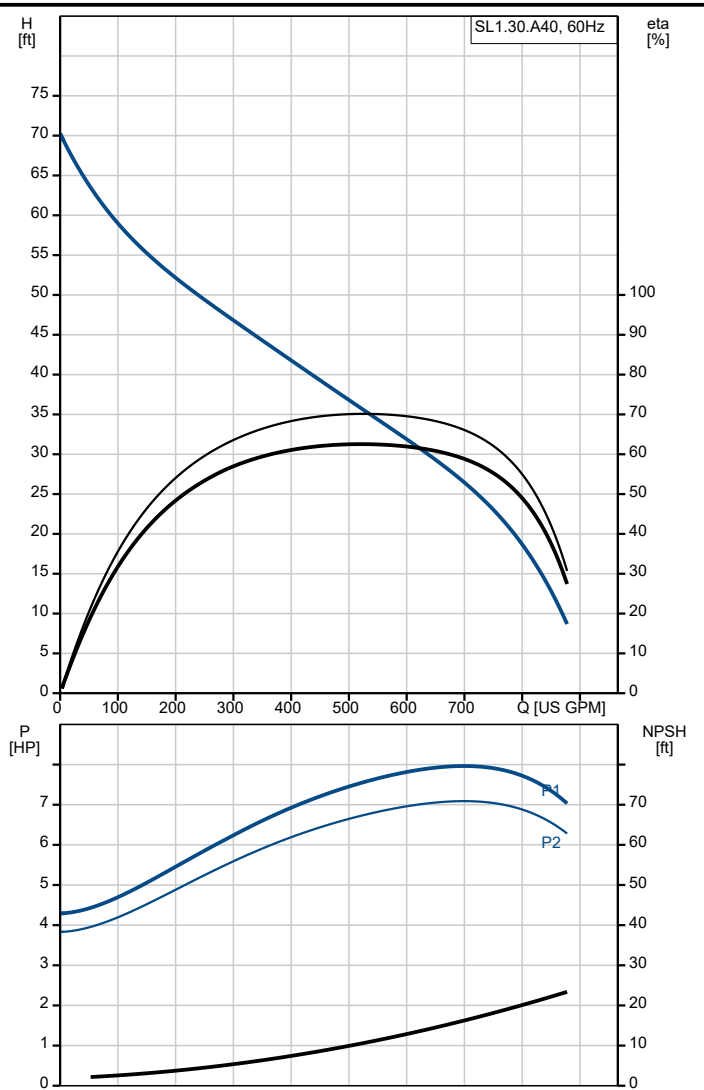

99030145 SL1.30.A40 .75.EX.4.61R.C 60 Hz

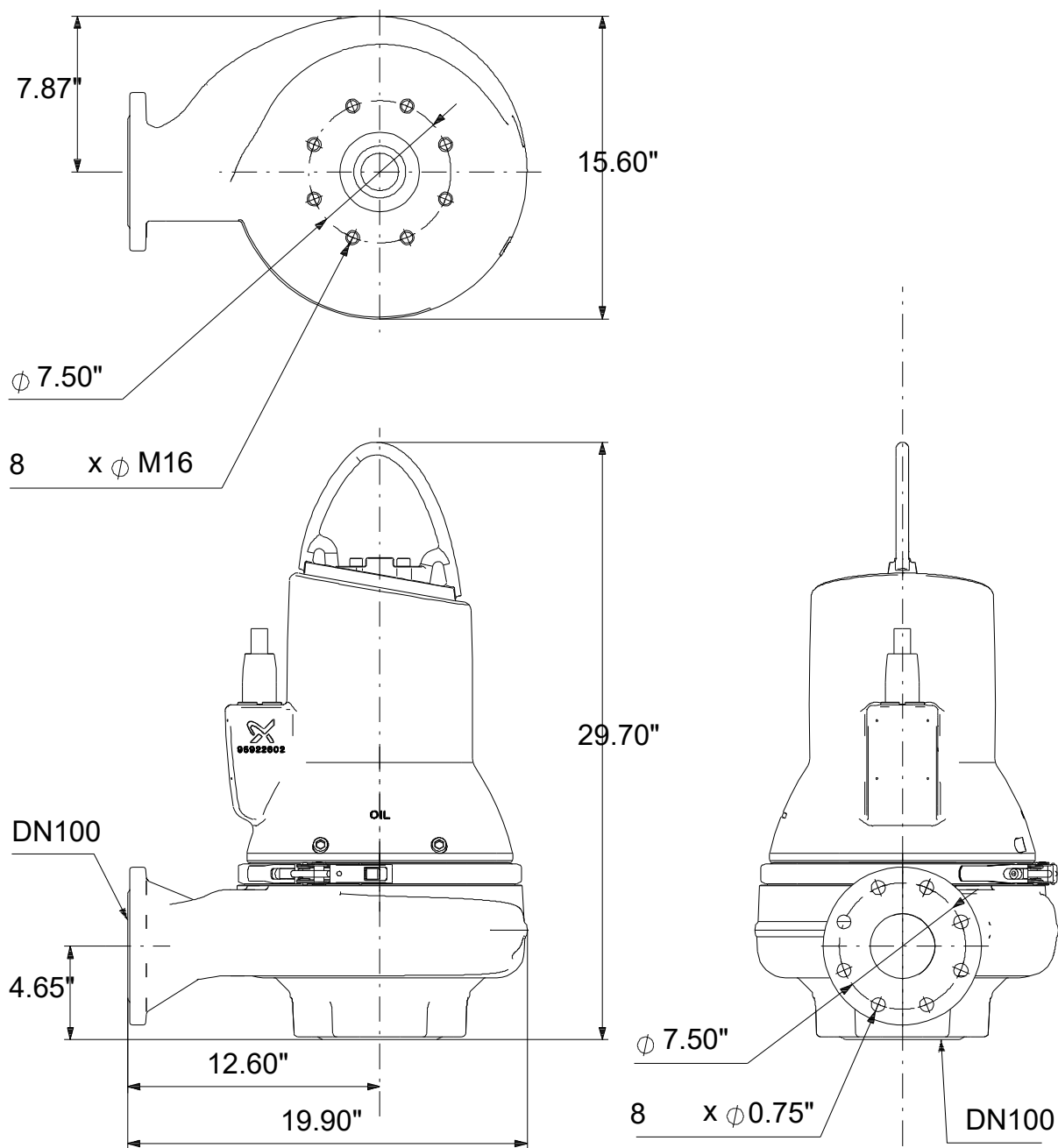

Note! All units are in [in] unless others are stated.
Disclaimer: This simplified dimensional drawing does not show all details.

99030145 SL1.30.A40 .75.EX.4.61R.C 60 Hz

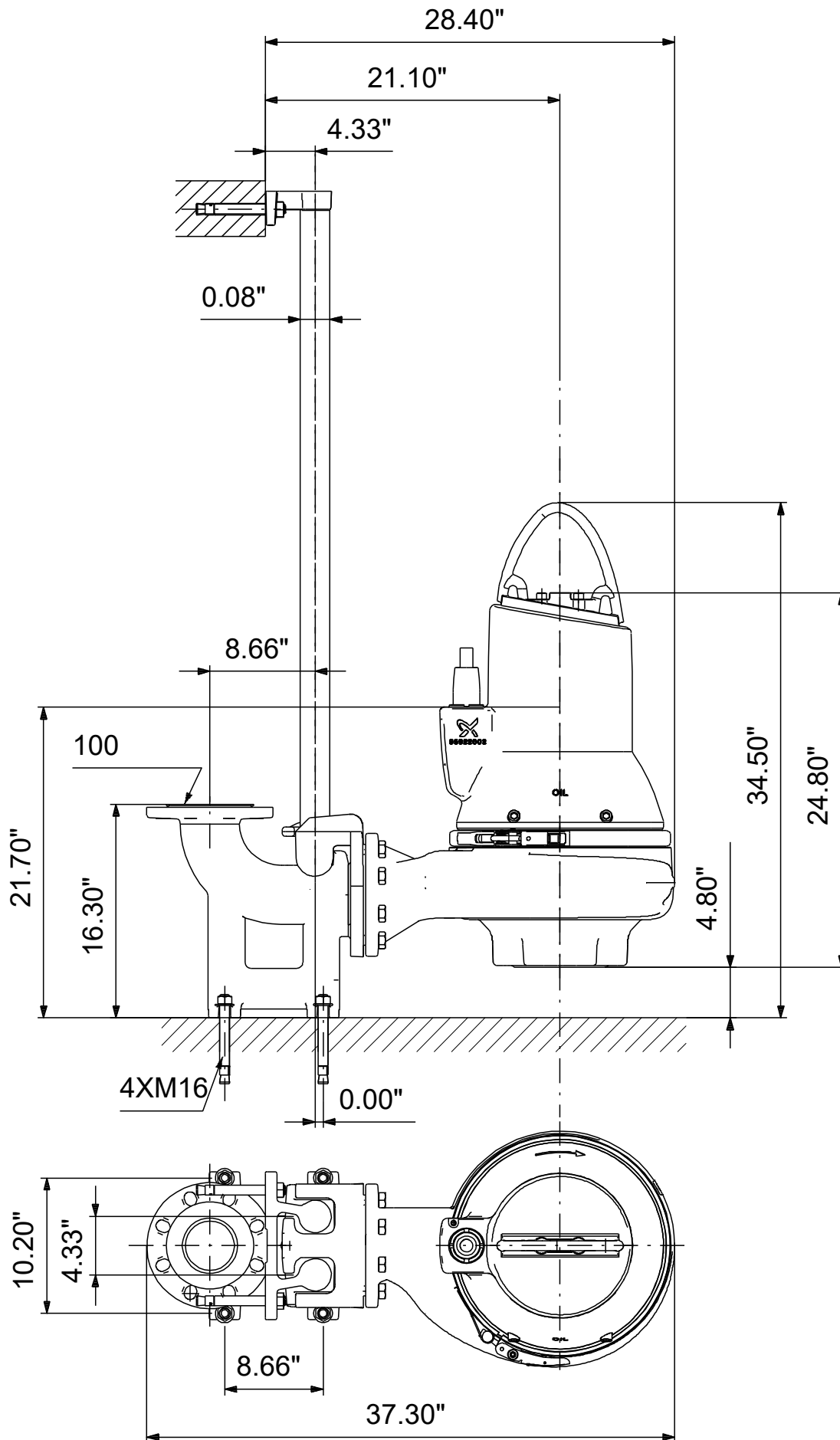

Note! All units are in [in] unless others are stated
Disclaimer: This simplified dimensional drawing does not show all details.

99030145 SL1.30.A40 .75.EX.4.61R.C 60 Hz

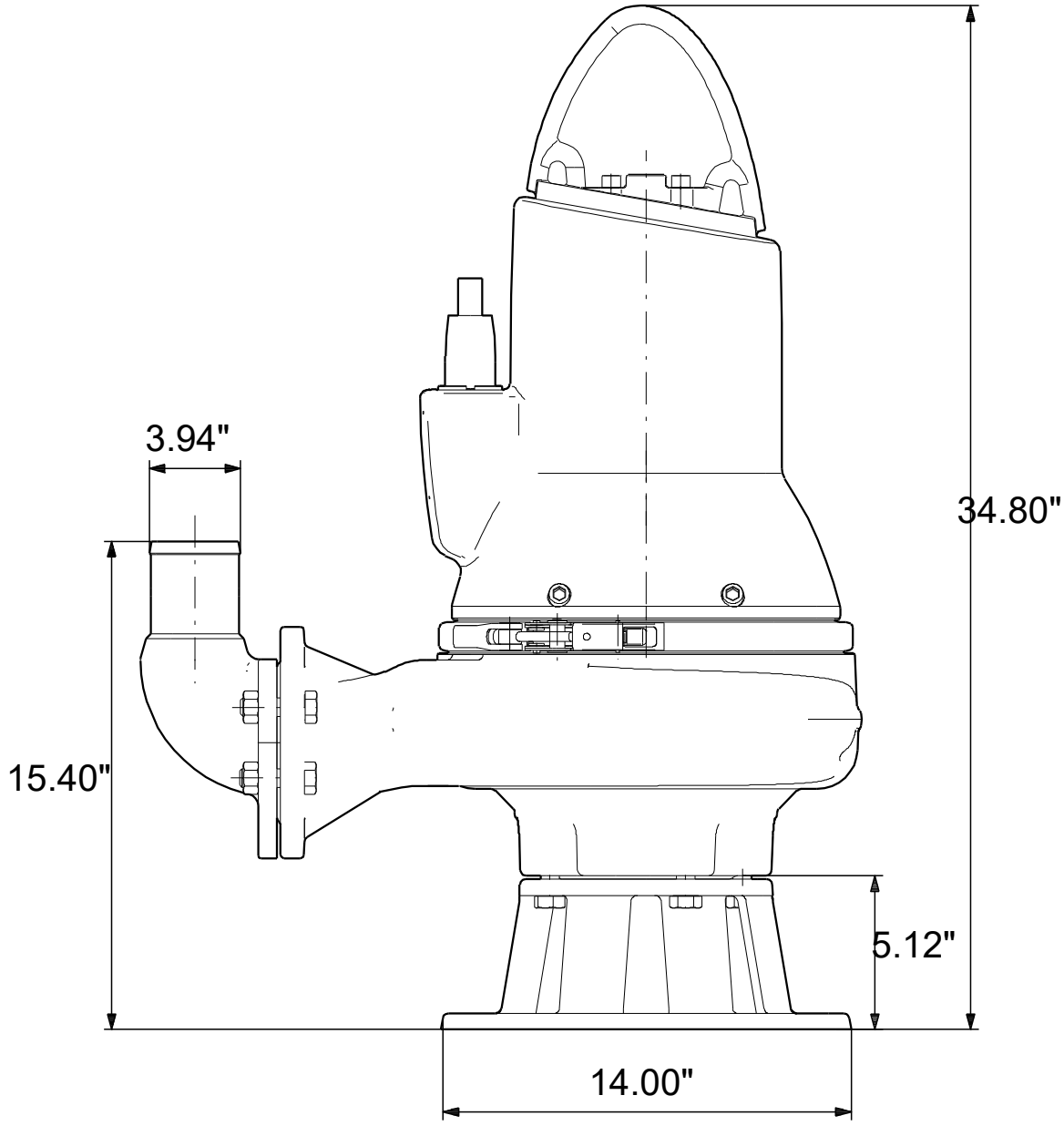
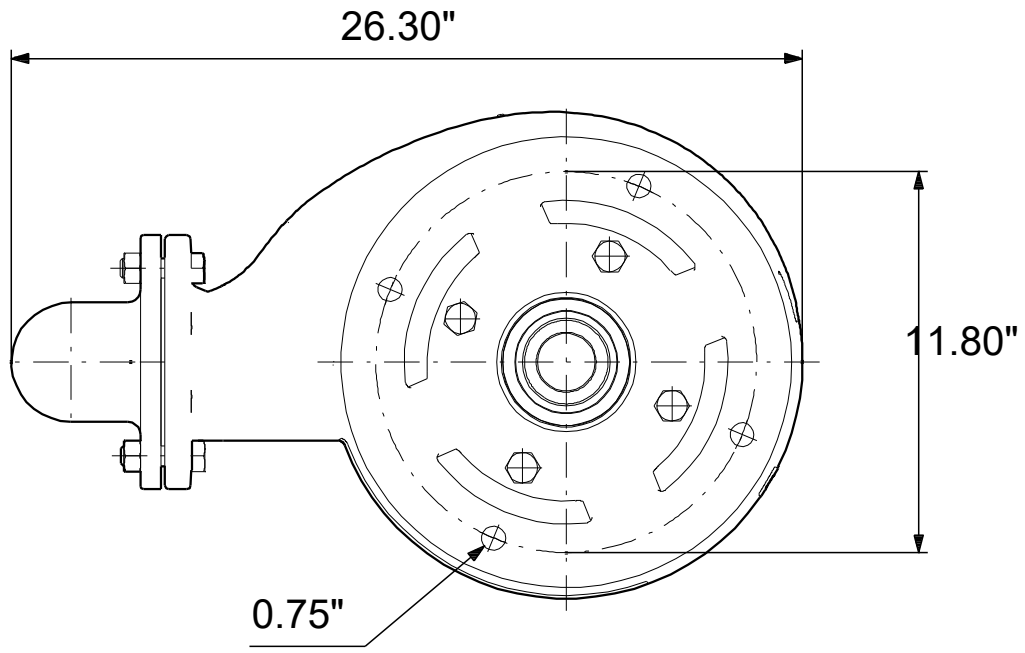

Note! All units are in [in] unless others are stated.
Disclaimer: This simplified dimensional drawing does not show all details.

99030145 SL1.30.A40 .75.EX.4.61R.C 60 Hz

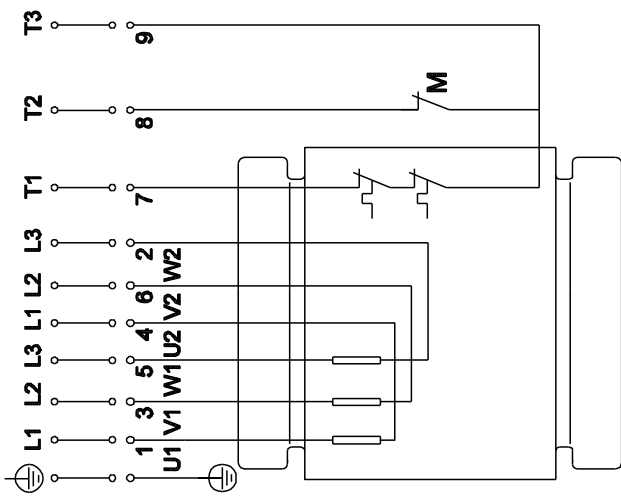
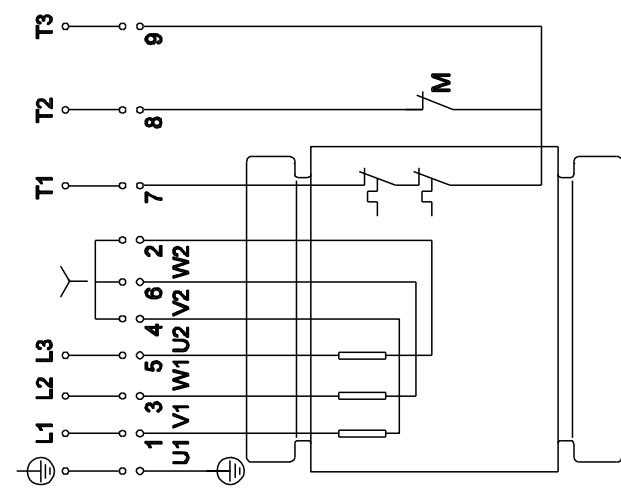
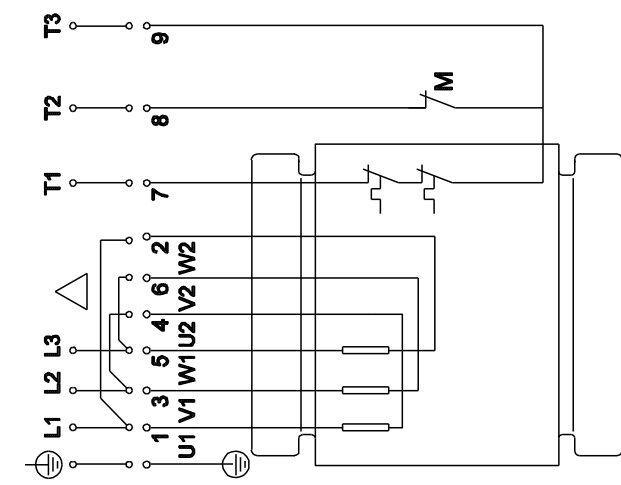
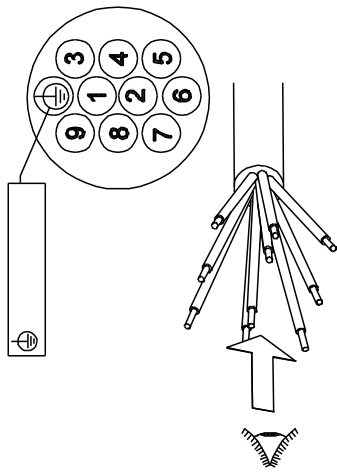

Note! All units are in [in] unless others are stated.