

## Pump Performance Datasheet

Customer :	Quote Number / ID :	1471203
Customer ref. / PO :	Model :	HYDRO MULTI-E 3CRE 20-1 3x460V
Tag Number : 001		60Hz
Service :	Part Number :	99761448
Quantity : 1	Stages :	1
Quantity of pumps : 3 active + 0 standby	Based on curve number :	RC10435
	Date last saved :	05/24/2022 5:52 PM

Operating Conditions		Liquid	
System flowrate	: 258.4 USgpm	Liquid type	: Cold Water
Flowrate per pump	: 86.14 USgpm	Additional liquid description	:
Differential head / pressure, rated (requested)	: 55.33 ft	Temperature, max	: 68.00 deg F
Differential head / pressure, rated (actual)	: 55.33 ft	Fluid density, rated / max	: 1.000 / 1.000 SG
Suction pressure, min / max	: 0.00 / 0.00 psi.g	Viscosity, rated	: 1.00 cP
NPSH available, rated	: Ample	Vapor pressure, rated	: 0.34 psi.a
Site Supply Frequency	: 60 Hz	Material	
Power Supply	: 3ph 460V	Material selected	: Standard - Cast Iron / 304 Stainless Steel
Performance		Pressure Data	
Speed, rated	: 3599 rpm	Pump shut off pressure	: 28.94 psi.g
Speed, maximum	: 3599 rpm	Maximum allowable suction pressure	: 116.0 psi.g
Speed, minimum	: 902 rpm	Driver & Power Data (@Max density)	
Pump efficiency	: 62.76 %	Motor sizing specification	: Max power (non-overloading)
NPSH required / margin required	: 5.09 / 0.00 ft	Margin over specification	: 0.00 %
nq (imp. eye flow) / S (imp. eye flow)	: 32 / 191 Metric units	Service factor	: 1.00
Head maximum, rated speed	: 66.87 ft	Rated power (based on duty point)	: 3 x 1.92 hp
Head rise to shutoff	: 20.86 %	Max power (non-overloading)	: 3 x 2.40 hp
Flow, best eff. point	: 86.14 USgpm	Motor rating	: 3 x 3.00 hp / 2.24 kW (Fixed)
Flow ratio, rated / BEP	: 100.00 %		
Speed ratio (rated / max)	: 100.00 %		
Head ratio (rated speed / max speed)	: 100.00 %		
Cq/Ch/Ce/Cn [ANSI/HI 9.6.7-2010]	: 1.00 / 1.00 / 1.00 / 1.00		
Selection status	: Acceptable		
Energy Indexes			
PEI (VL)	: 0.41		
ER (VL)	: 59		

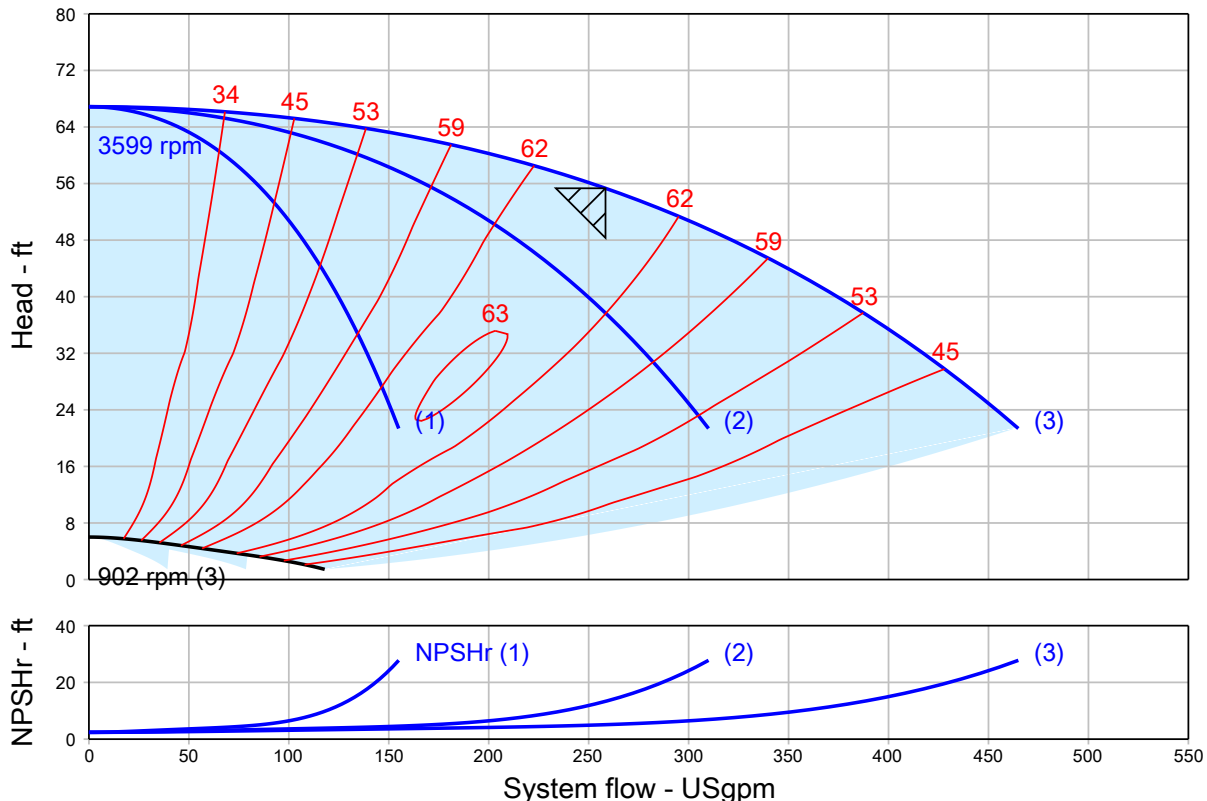

1. Manifolds 4" ANSI Class 150 AISI 316SS Schedule 10s ASTM A312 or  $\varnothing$  114.3mm x2mm
2. Base/Frame AISI 304SS
3. Full port ball valve ASTM
4. UL Type 3R Fuse Box

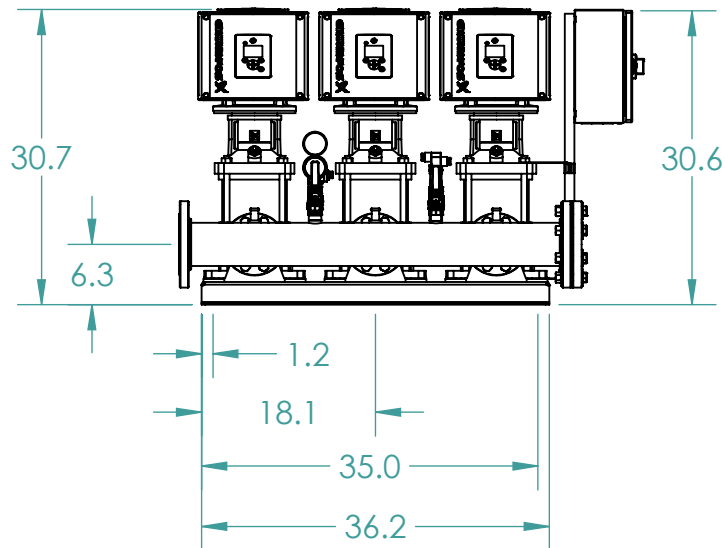
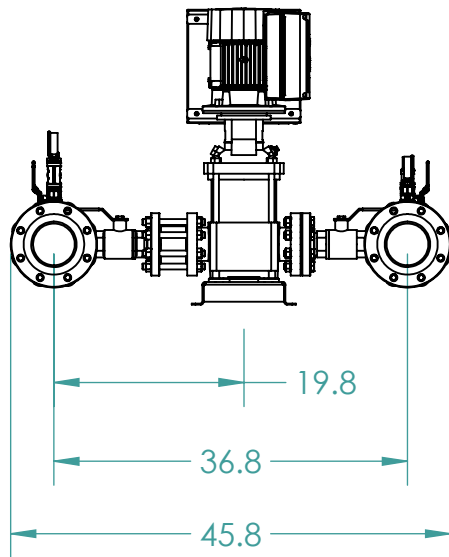
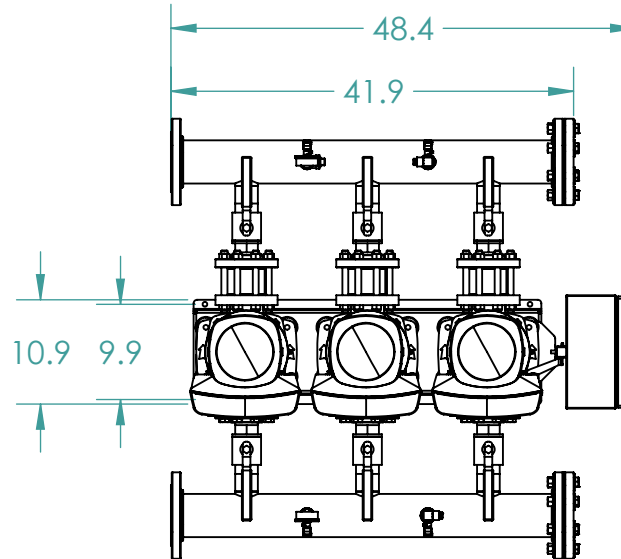
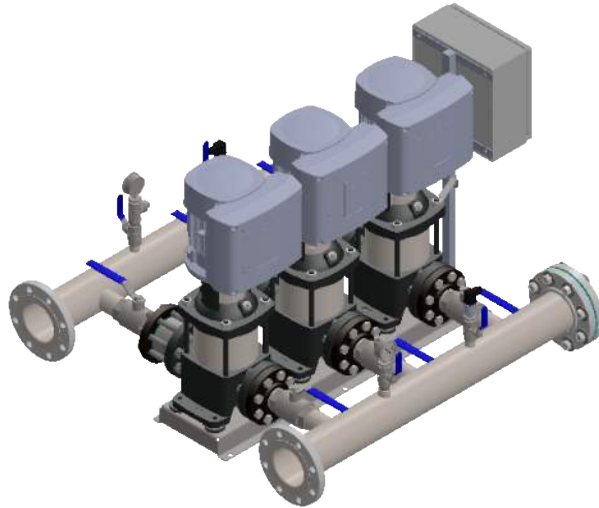

**GRUNDFOS**   
 FRESNO, CALIFORNIA 93727 USA

Note:  
 All dimensions are  $\pm 0.5"$   
 Not for Construction  
 All dimensions subject to  
 changewithout notice.

BoosterpaQ Model: HYDRO MULTI-E 3CRE20-1

Power: 3x460 60HZ 3x3HP

Job:

Scale: 1:20

Dwg No: 99334055

Rev: 0

Date: 5/24/2018

Drawer 71999

Page: 1 of 1

## MLE

### Product compatibility

- **Multi-stage:** CRE, CRIE, CRNE, MTRE, MTSE, SPKE, CME
- **Single-stage:** TPE2, TPE3, VLSE, LCSE
- **Systems:** Hydro MPC-E, Hydro Multi-E, Hydro Multi-B, Hydro Solo-E, CMBE home booster.



TM06 5684 2219

MLE is a dedicated motor-drive system for pumps and other applications. Pumps equipped with MLE motors overcome application challenges and save energy in a variety of pump installations in order to reach the lowest Life Cycle Cost (LCC) possible.

### Integrated drives

Integrated drives are beneficial because they are installed on non-controlled pumps at no additional installation cost. Once the power supply is connected and the pump is fitted into the pipe system, they are ready to operate at the desired setpoint.

Operating pumps with MLE also reduces CAPEX (capital expense) of additional cabinets, components and facility space by having the entire pump system in line with the pipe system.

MLE is the result of Grundfos' efficient motor technology and it is an efficient IE5 motor, with an efficiency much higher than NEMA Premium, which minimizes OPEX (operating expense).

### Robustness throughout the system

The Grundfos full line supply of components, from the power supply to pipe fittings, provides the most robust solutions:

- Built-in protection against power supply disturbances, environment and motor load.
- MLE is designed to mitigate bearing currents.
- No cooling fans in drive (wear part).

### MLE product range

1 x 200-240 V	0.33 - 2.0 HP
3 x 200-240 V	1.5 - 7.5 HP
3 x 440-480 V	0.33 - 15 HP*

\* Up to 30 HP available with different specifications.

### Features and benefits

Feature	Benefit
<b>Application control</b>	
Control modes	Easy commissioning to match system design criteria.
Multipump function including alternating, back-up, or cascade	Neglects the need for external controllers and continuous operation by redundant pump and sensor if either component fails.
Differential pressure or temperature with 2 sensors	Lower CAPEX by common inexpensive sensor types.
Pump curve adjustments and run at power limit	Stabilizes unstable pump curves and extends operating range.
Setpoint influence	Adapts QH to internal or measured values.
<b>Energy saving for lower OPEX</b>	
AUTOADAPT or FLOWLIMIT	Continuously adapts to the most efficient curve and reduces pressure loss in the system.
Low-flow stop function	Improved energy optimization and comfort.
ECM motor that exceeds the NEMA Premium efficiency levels	ECM motors have significantly lower motor loss than NEMA Premium motors. This alone reduces energy consumption by 10 % with a typical pump load profile.
<b>Condition monitoring</b>	
Limit Exceed function	Any value can be supervised to protect the system.
Loss of prime and dry run	Protects the shaft seal.
Cavitation protection	Protects the impellers.
Flow estimate and heat energy monitor	Monitoring of the heating system's performance.
Overload and temperature	Protects the frequency converter and motor.
Stop at minimum speed	Protects the pump and saves energy.
Motor bearings monitors	Ensures uptime by preventive maintenance.
<b>Robustness</b>	
Operating temperature between -4 and +140 °F	Allows installation almost anywhere and high margins in control rooms, resulting in longer product service life.
Impulse transient resistance (VDE0160 compliant)	Resistance against lightning, ESD, switching impulses and utility fault clearing.
Interruptions and voltage sags (SEMIF47 compliant)	Keeps process running and derates the pump to the available power.
Line harmonics resistance (EN 61000-4-13, class 3)	Built-in compensation of disturbance to avoid overheating of motor windings and maintaining a steady pump operation.
Built-in RFI filters	Neglects the need for external components.
NEMA3 / NEMA4 enclosures	Installed in-line to pipe systems at no added cost.

## Grundfos iSOLUTIONS

Grundfos iSOLUTIONS delivers the optimal combination of pumps, drives and auxiliary components for the specific application, incorporating special features and functions, and building on application knowledge and experience.

Grundfos iSOLUTIONS allows easy integration of pumps, drives, measurements, controls, protections, and communication, saving you valuable engineering, installation and commissioning time.

To learn more, visit: [www.grundfos.com/isolutions](http://www.grundfos.com/isolutions)

## Sensors

MLE is sensor-independent and controls the pump to any measured feedback.

Grundfos offers several sensors to be used in pump solutions:

- pressure sensors
- temperature sensors
- differential pressure sensors
- differential temperature sensors
- flow meters.

## Grundfos GO Remote

Grundfos GO Remote for iOS and Android ensures easy and quick commissioning, monitoring and servicing of pumps with MLE motors.



TM107 4786 2419

<b>99689406</b> 0719
ECM: 1264915

## Technical specifications

Motor data			
	Operating range (rpm)	Constant power (rpm)	Constant torque (rpm)
Speed range	180-2000	1740-2000	900-1740
	360-4000	3480-4000	1750-3480
	360-4000	3400-4000	2000-3400
	500-5900	4000-5900	-
Voltage tolerances	± 10 %		
Frequency	50-60 Hz ± 5 %		
Network	TN/TT (optional: IT) according to IEC 60364		
Environmental limits			
Degree of protection	NEMA3 / NEMA4		
Operating temp.	-4 to +140 °F derating above 122 °F		
Storage temp.	-4 to +140 °F		
Altitude	0-3280 ft without derating / 0-11480 ft with derating		
Humidity	0-95 %, non-condensing		
Inputs/outputs	<b>FM100</b>	<b>FM200</b>	<b>FM300</b>
Digital inputs	1	1	2
Digital inputs/ outputs	1	1	2
Relay outputs	-	2	2
Analog inputs	1 (only V)		
Pt100/Pt1000 inputs	-	-	2
+5 V supply	Y	Y	Y
+24 V supply	-	Y	Y
Grundfos Digital Sensor input	-	Y	Y
LiqTec sensor input	-	-	Y
Digital inputs (dedicated)	0-5 V		
Digital inputs/ outputs	0-24 V, resistive or inductive		
Analog input	0-20 mA / 4-20 mA, 0.5 - 3.5 V / 0-5 V / 0-10 V		
Relay output	250 V AC/30 V DC, max. continuous current 2 A rms		
Connectivity			
Wireless (radio)	Yes, GENlair		
RS-485	Yes, GENlair		
Communication options	• LONWorks (CIM 100)		
	• PROFIBUS DP (CIM 150)		
	• Modbus RTU (CIM 200)		
	• GSM/GPRS (CIM 250)		
	• 3G/4G cellular (CIM 260)		
	• GiC/GRM 3G/4G (CIM 280)		
	• BACnet MS/TP (CIM 300) PROFINET IO (CIM 500)		
	• Modbus TCP (CIM 500)		
	• BACnet IP (CIM 500)		
	• Ethernet IP (CIM 500)		
Compliance			
Conformity to standards	CE, EAC, RCM, CCC, and cURus (UL)		
Harmonics	IEC/EN 61000-3-12		
EMC	Up to 10.0 HP (7.5 HP low speed): Category C1 according to EN 61800-3, corresponding to CISPR 11, class B (residential area)		
	Above 10.0 HP (7.5 HP low speed): Category C3 according to EN 61800-3, corresponding to CISPR 11, class A, group 2 (industrial area)		

## Vibration Isolation

### Common vibration concerns with frame mounted end suction pumps

- Misalignment between motor shaft and pump shaft is the #1 source of pump vibration
  - o End suction pumps typically have large over-hung impellers with high rotating inertia, that when misaligned creates large unbalanced forces and results in vibration
  - o Offset discharge throat of the volute creates the radial load
  - o Decreased component life
- End suction pump bearing loading is primarily from radial forces



Unbalanced forces and increased vibration

### Grundfos CR Multistage pump benefits:

- Register fit between motor and pump
- No alignment required for lifetime of operation
- Minimized vibration
- Longer component life
- Quiet operation (product lubricated pump bearings)
- CR Multistage pumps offer the lowest rotating inertia compared to most other pumps in same duty conditions
- Low rotating inertia equals less opportunity for vibration
- Multistage pump bearing loading is on average 10% radial and 90% axial forces



No alignment is required

### Pump systems with Grundfos CR(E) Multistage pumps

- Vibration Isolation:
  - o 1/2" thick dampeners at pump base mounting points (4 per pump)
  - o Inertia bases and grouting are not required when mounted to concrete housekeeping pad
  - o Flexible connectors on manifold connections are recommended

