

## Pump Performance Datasheet

Customer :	Quote Number / ID :	1471203
Customer ref. / PO :	Model :	CR 3-8-3ph
Tag Number : 001	Stages :	8
Service :	Based on curve number :	CR 3-8_3Phase Rev June_2020
Quantity : 1	Basic model number :	-
	Date last saved :	11/28/2022 2:26 PM

Operating Conditions		Liquid	
Flow, rated	: 16.60 USgpm	Liquid type	: Cold Water
Differential head / pressure, rated (requested)	: 178.8 ft	Additional liquid description	:
Differential head / pressure, rated (actual)	: 178.8 ft	Temperature, max	: 68.00 deg F
Suction pressure, rated / max	: 0.00 / 0.00 psi.g	Fluid density, rated / max	: 1.000 / 1.000 SG
NPSH available, rated	: Ample	Viscosity, rated	: 1.00 cP
Site Supply Frequency	: 60 Hz	Vapor pressure, rated	: 0.34 psi.a

Performance		Material	
Speed, rated	: 3466 rpm	Material selected	: Standard - Cast Iron / 304
Efficiency	: 56.65 %		Stainless Steel
NPSH required / margin required	: 10.12 / 0.00 ft	<b>Pressure Data</b>	
nq (imp. eye flow) / S (imp. eye flow)	: 27 / 48 Metric units	Maximum working pressure	: 108.6 psi.g
MCSF	: 1.66 USgpm	Maximum allowable working pressure	: N/A
Head, maximum, rated diameter	: 250.9 ft	Maximum allowable suction pressure	: N/A
Head rise to shutoff	: 40.30 %	Hydrostatic test pressure	: N/A
Flow, best eff. point	: 16.59 USgpm	<b>Driver &amp; Power Data (@Max density)</b>	
Flow ratio, rated / BEP	: 100.06 %	Motor sizing specification	: Max power (non-overloading)
Diameter ratio (rated / max)	: 100.00 %	Margin over specification	: 0.00 %
Head ratio (rated dia / max dia)	: 100.00 %	Service factor	: 1.15 (used)
Cq/Ch/Ce/Cn [ANSI/HI 9.6.7-2010]	: 1.00 / 1.00 / 0.97 / 1.00	Power, hydraulic	: 0.75 hp
Selection status	: Acceptable	Rated power (based on duty point)	: 1.32 hp
<b>Energy Indexes</b>		Max power (non-overloading)	: 1.44 hp
PEI (CL)	: Out of scope	Motor rating	: 1.50 hp / 1.12 kW (Fixed)
ER (CL)	: Out of scope	KVA Code	: -
		Rated Current new	: 4.14 - 3.74 / 1.87 A

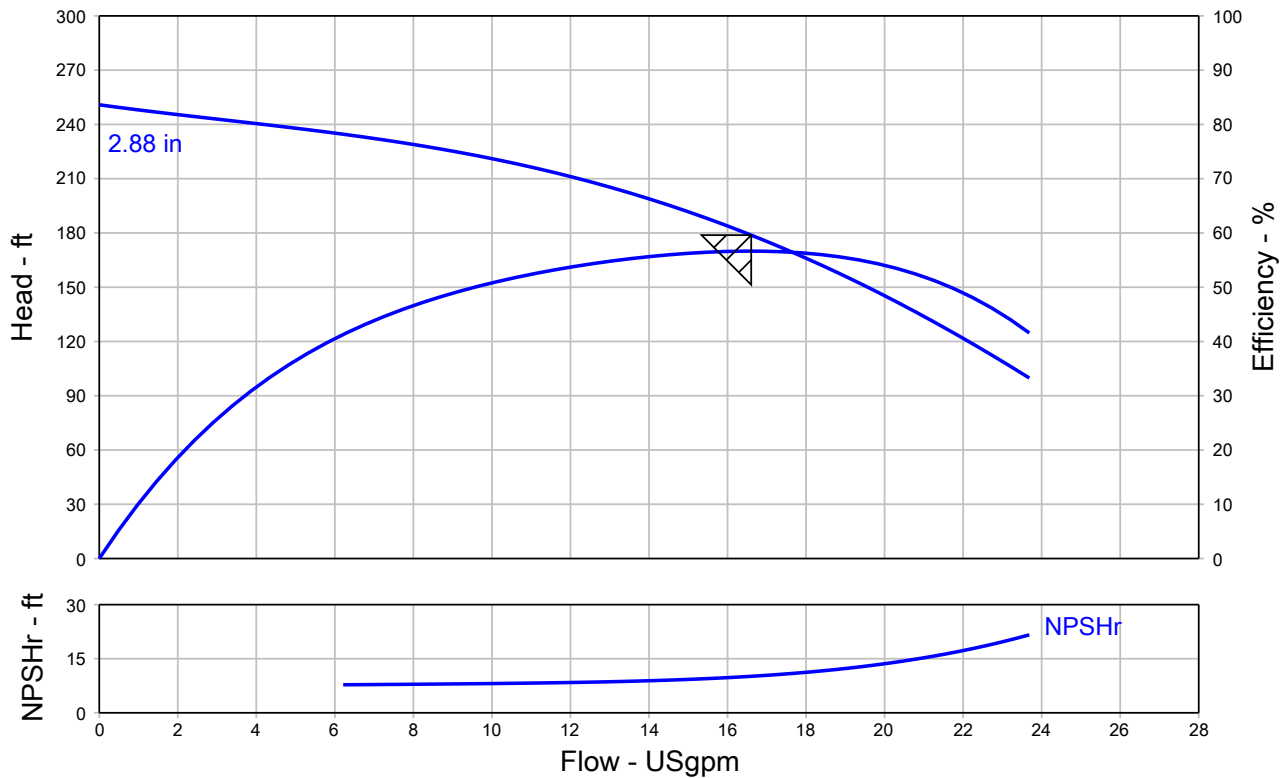

## Grundfos Series CR - Multi-stage, Vertical In-Line Pump

QUOTE NUMBER / ID 1471203	UNIT TAG 001	QUANTITY 1
REPRESENTATIVE	SERVICE	DATE
ENGINEER	SUBMITTED BY	DATE
CONTRACTOR	APPROVED BY	DATE
	ORDER #	DATE



**CR 3-8-3ph**  
**3466 rpm**

Part Number 99916345

Conditions of Service		Pump Data		Motor Data	
Flow	16.60 USgpm	Stages	8	Motor HP	1.5 HP
Head	178.8 ft	Stages Reduced	0	BHP	1.32 HP
Liquid	Cold Water	Pipe Connection	ANSI Flanged	Enclosure	TEFC
Temperature	68.00 deg F	Efficiency	56.65 %	Voltage	208-230/460 V
NPSHr	10.12 ft	Suction	1.25 in.	Phase	3 Phase
Viscosity	1.00 cP	Discharge	1.25 in.	Cycle	60
Specific Gravity	1.000 SG	Shaft Seal Type	HQQE (EPDM)		
		NSF 61 Approval	Yes		
		PEI (CL)	Out of Scope		
		ER (CL)	Out of Scope		

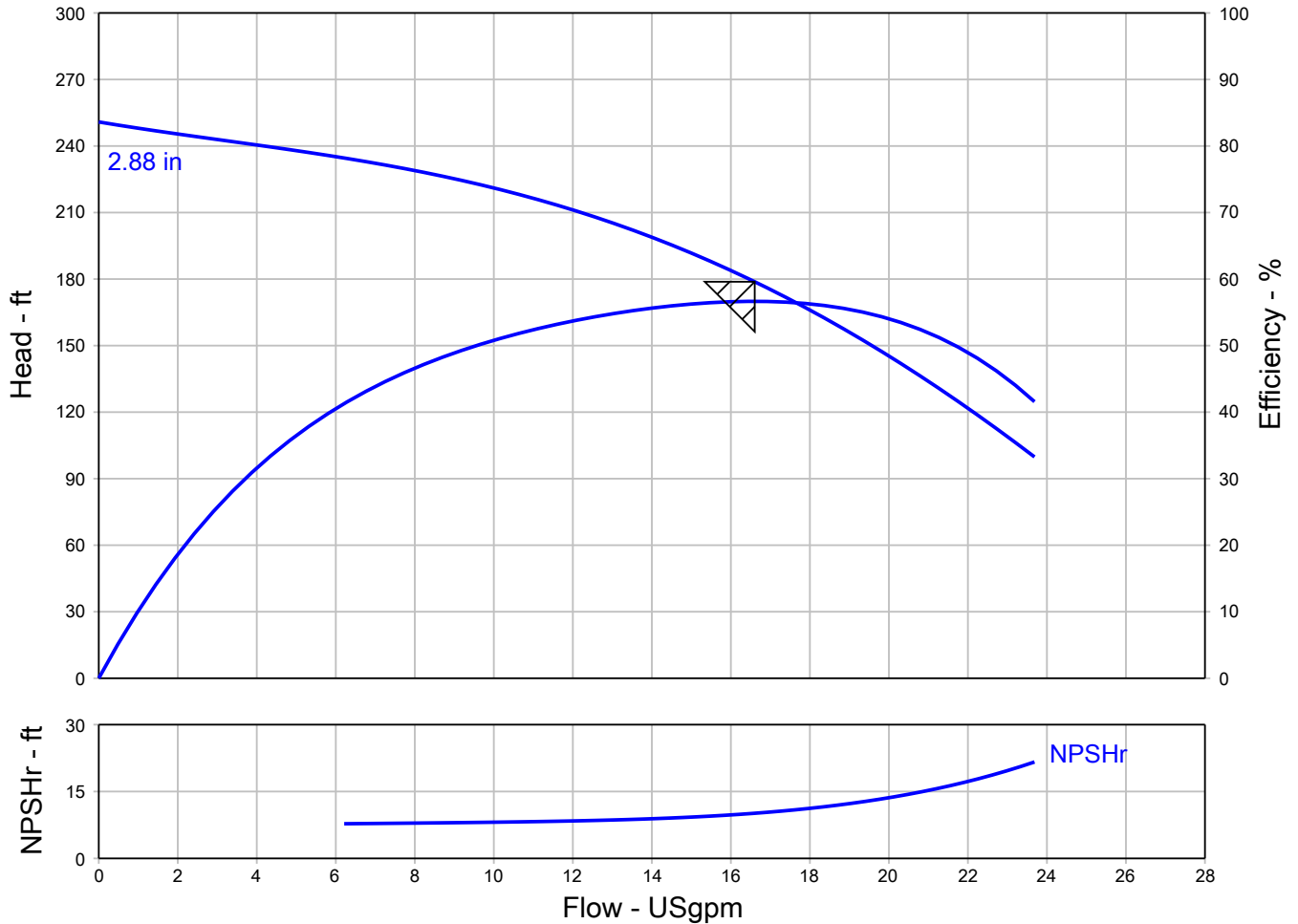

**Grundfos Series CR - Multi-stage, Vertical In-Line Pump**

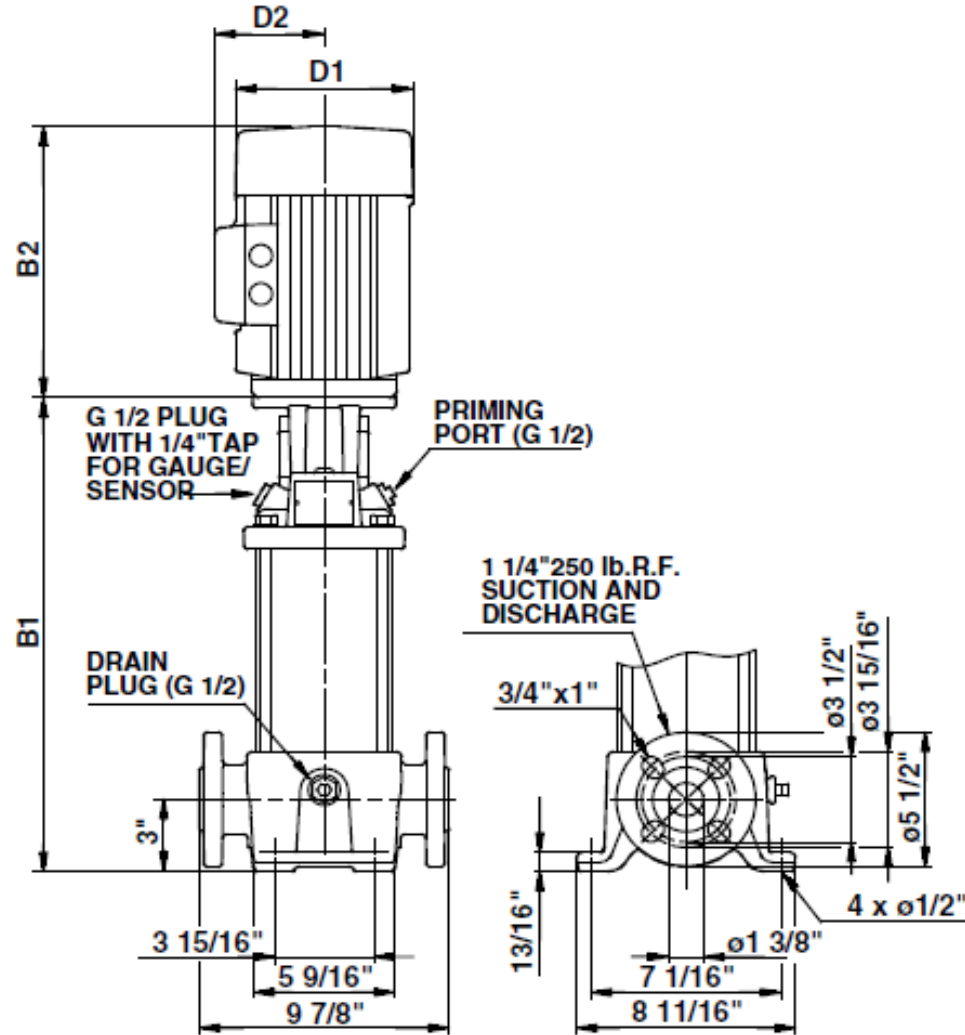

TM03 1451 2205

NOT FOR CONSTRUCTION, unless certified and referenced on order

Units	B1	B1 + B2	D1	D2	Weight
inches	15.51	27.19	7.64	5.88	78.9 lbs