

CR, CRN 30•60 Dismantling & Reassembly

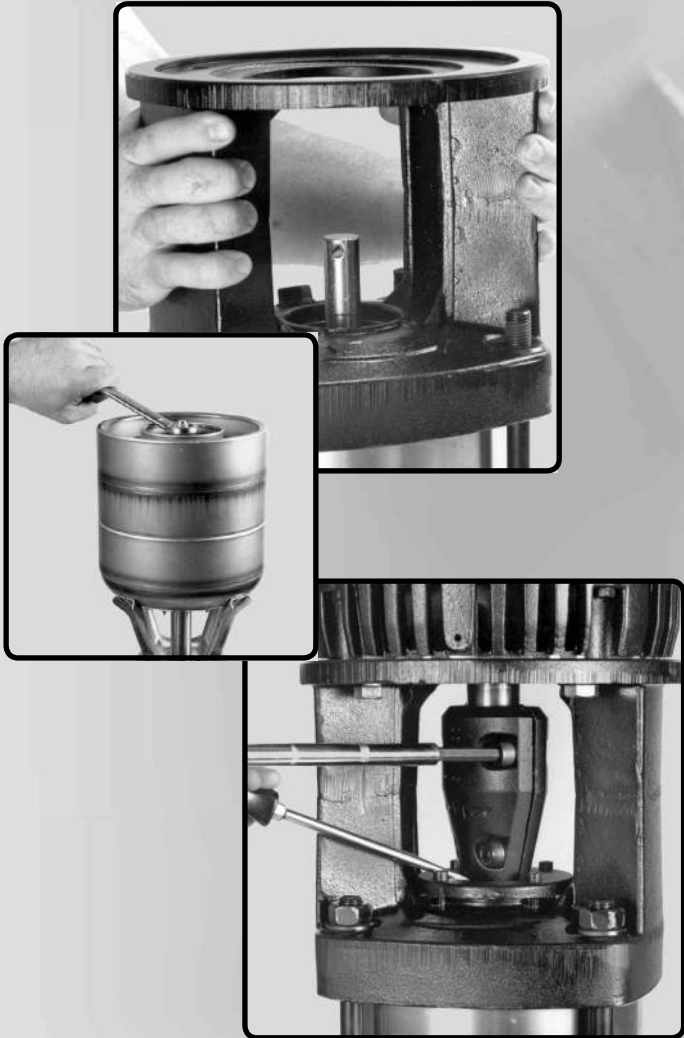

CONTENTS

Dismantling Procedures.....Page 2
 When Should A Part Be Replaced ? Page 6

Reassembly Procedures Page 7
 Setting The Coupling HeightPage 10
 Order of Stage Assembly - CR30 (Model A).....Page 11
 Order of Stage Assembly - CR30 (Model B)..... Page 12
 Order of Stage Assembly - CRN30..... Page 13
 Order of Stage Assembly - CR60 (Model A) Page 14
 Order of Stage Assembly - CR60 (Model B) Page 15
 Order of Stage Assembly - CRN60.....Page 16

TORQUES

Non "N" Model A Pumps (Reassembly step 5)
 Split cone nut.....55 ft.-lbs./75 Nm

"N" Pumps and Model B Pumps (Reassembly step 10)
 Lock nut44 ft.-lbs./60 Nm

All Pumps
(Reassembly step 16):
 Lower seal driver10 ft.-lbs./13 Nm
 Staybolt nuts, M16.....75 ft.-lbs./100 Nm
 Staybolt nuts, M18.....100 ft.-lbs./138 Nm

(Reassembly step 20 & 21):
 Seal carrier screws 8 ft.-lbs./10 Nm

(Reassembly step 22):
 Motor bolts.....30 ft.-lbs./41 Nm

(Reassembly step 24):
 Coupling screws46 ft.-lbs./62 Nm

Dismantling Procedures CR, CRN 30•60

In the instructions that follow, the numbers in parenthesis (7) indicate the position number of that part as it is shown on the Parts List and Kits diagram.

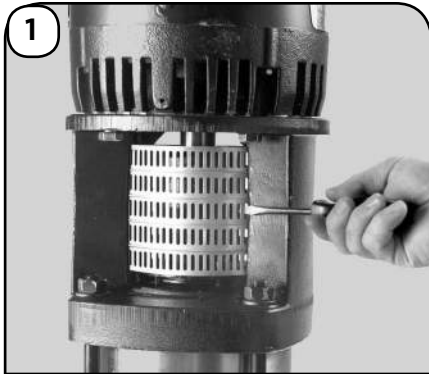

1 Using a screwdriver, hook into the two coupling guards (7) and remove them. For solid type guards, remove screws (7a).

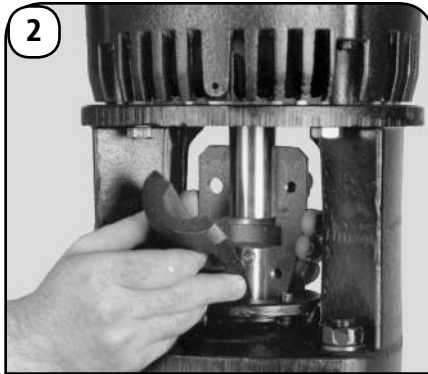

2 Using an allen wrench, remove the allen screws (9) in the coupling and remove the two coupling halves (8). Remove the shaft pin (10) from the shaft.

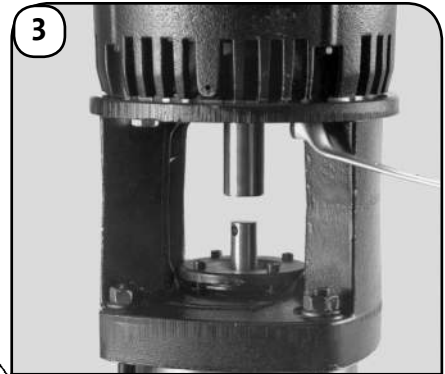

3 Using a box wrench, loosen the motor bolts (28) diagonally and remove them. Lift the motor off the pump.

Diagonal loosening (overhead view) 

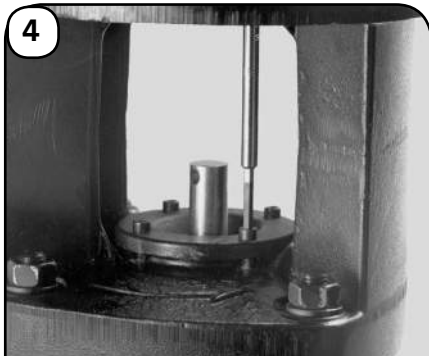

4 Using an allen wrench, remove the screws from the seal carrier. Gently separate and remove the seal carrier by prying it up with a screwdriver. Using a box end wrench, loosen the staybolt nuts (36) diagonally and remove them from the motor stool.

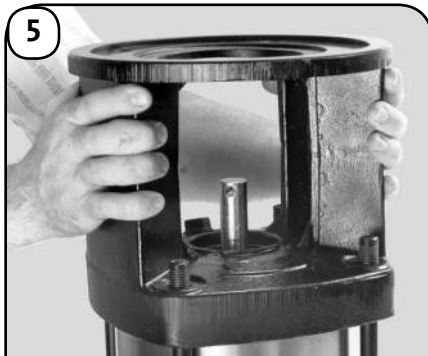

5 Remove the motor stool (2). A light, upward blow with a rubber mallet may be needed to jolt it free. Remove the outer sleeve (55).

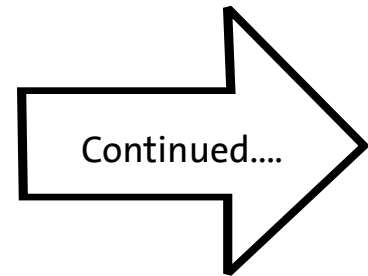

NOTE FOR 6 AND 7 BELOW:

The pumps can be fitted with either an o-ring seal or a bellows seal. To determine which type of seal configuration is used, read the "type" field on the pump nameplate attached to the motor stool. If the four-letter seal code (see "Reading the Pump Nameplate") begins with the letter "A," the seal is an o-ring type (e.g., AUUE). If the first letter of the seal code begins with a "B," it is a bellows type seal (e.g., BUBE). Go to step 6 for the bellows seal, or step 7 for the o-ring seal. Non "N" (Model A) pumps and pumps with six stages or more must use O-ring seal.

6

BELLOWS SEAL OPTION

COMPONENTS OF THE BELLOWS SHAFT SEAL (pos. 105)

UPPER SEAL ASSEMBLY



Secondary Seal (rubber)



Stationary Seat (Tungsten Carbide)

(lower assembly removed as one unit)

LOWER SEAL ASSEMBLY



Rotating Face (carbon)



Upper Seal Driver



Spring



Rubber Bellows



Lower Seal Driver

Remove the lower half of the bellows shaft seal assembly (pos. 105) from the shaft. The upper half will remain in the seal carrier. Skip to step 10.

7

O-RING SEAL

LOWER COMPONENTS OF THE O-RING SEAL ASSEMBLY



Pos. 104
Lower Seal Ring
(tapered end pointing downward)

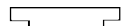

Pos. 111
Upper Seal Driver



Pos. 107
O-Ring



Pos. 106
Cup for Spring



Pos. 108
Shaft Seal Spring

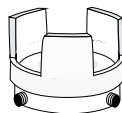

Pos. 112
Lower Seal Driver

Remove the lower seal ring (104), upper seal driver (111), O-ring (107), spring retainer (106), and spring (108).

8



Remove the lower seal driver (112) by loosening the allen screws in its side (113). A screwdriver may be needed to pry it up and off. **Take note where the allen screws made scratch marks on the shaft.**

9

NON "N" MODEL A PUMPS ONLY







Lift the impeller stack off the suction/discharge chamber, along with the bottom bearing (44). A screwdriver may be needed to pry it loose. Remove the sleeve gasket (37) from the suction/discharge chamber.



Fit the Shaft Holder (material # 00SV0117) to the bottom bearing retainer of the impeller stack and use a wrench to tighten the screw snug. Clamp the shaft holder in a vise.

<p>10 "N" PUMPS AND MODEL B PUMPS ONLY</p> <p>Place the Shaft Holder for Dismantling (material #00SV0861) in a vise and tighten it. Lift the impeller stack off the suction/discharge chamber. A screwdriver may be needed to pry it loose. The bottom plate (44) should remain in the suction/discharge chamber.</p> <p>Flip the impeller stack upside down and place it in the Shaft Holder. Use a wrench to loosen the lock nut (67) and remove it and the washer (66). Remove the first impeller (49), chamber (4a), and any spacers. If they are too tight to remove by hand, then...</p>		<p>FOR EXTREMELY TIGHT OR "STUCK" IMPELLER STACKS</p> <p>↓</p> <ol style="list-style-type: none"> Screw the Punch for removing the shaft (00SV0867) onto the threaded shaft. Make sure there is clearance under the shaft holder so the shaft can pass through it freely (clear of the vise). Using a rubber mallet, drive the shaft down past the hub of the first impeller. Remove the impeller (49), chamber (4 or 4a), and any spacers. Repeat these steps until you get down to the last impeller. (Refer to the diagrams on pages 11-16 to see what you can expect in the pump you are working with). Gently knock the punch down through the hub of the last impeller, making sure to catch it if it falls free.
---	---	---

<p>11 NON "N" MODEL A PUMPS ONLY</p>		
		
<p>Lift off the top chamber (3). If it sticks, gently tap it with a rubber mallet to jolt it free.</p>	<p>Using the special spanner wrench (material #00SV0121), loosen the first split cone nut (48). If the shaft rotates as you use the wrench, hit the wrench a few times with a hammer to break the split cone free.</p>	<p>Turn the wrench over and hammer the other side to drive the split cone nut down. This will loosen the impeller.</p>

<p>12 NON "N" MODEL A PUMPS ONLY</p>		<p>13</p> <p>The dismantling procedures from this point on will depend on the type of pump and number of stages it contains. Refer to the diagrams on pages 11-16 of the Reassembly section to determine what you can expect in the pump you are working with.</p> <p>Follow these diagrams and continue to remove impellers, spacers, and chambers until the impeller stack is completely disassembled.</p>
		
<p>Remove the impeller (49), split cone nut (48), and the split cone (49b) as a unit. If they do not come off easily, remove them separately by unscrewing the split cone nut all the way off the split cone.</p>	<p>Lift off the chamber (4). If the chambers stick together, use a screwdriver to pry them apart or tap one with a rubber mallet to break them apart.</p>	

14 NON "N" MODEL A PUMPS ONLY



Remove the shaft holder from the vise and remove the set screw. Remove the shaft.



15



Use a punch (material #00SV0227) to remove the intermediate bearings (47).



16



For each chamber (4) and the bottom bearing (44), use a screwdriver to pry up and remove the neck ring (45).

17 NON "N" MODEL A PUMPS ONLY



Using a screwdriver, remove the screws holding the seal carrier together. Remove the two O-rings (109 and 102) and the upper seal ring (103).



18 "N" PUMPS AND MODEL B PUMPS ONLY

"N" Pumps Only









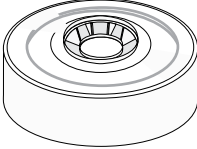
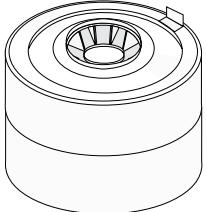

(a) Remove the pump head cover (77) from inside the motor stool by loosening the pipe plug (18), setting it ajar, and hitting it with a rubber mallet to jolt the pump head cover free.

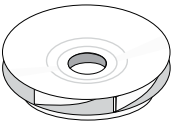
(b) Using a screwdriver, pry up and remove the bottom plate (44) from the suction/discharge chamber. Remove the outer sleeve gasket (37).



THE PUMP
IS NOW
COMPLETELY
DISASSEMBLED.

When Should A Part Be Replaced ?

Part	Position(s)	Minimum Operating Condition	
Motor Stool	2	Excessive pitting of these castings could cause leaks. Rusted castings should have all seating areas cleaned to ensure proper seating of O-rings and sleeve gaskets.	
Suction/Discharge Chamber	6		
Chambers	3, 4	Same as for impellers.	 or 
Neck Ring	45	Should be free of visible wear on the inside edges Inside diameter for CR30 = 63.5 mm Inside diameter for CR60 = 76 mm	
Bearing ring	47a	"N" Pumps and Model B Pumps Only -- The diameter size difference between the bearing ring (47a) and the bearing fixed inside the intermediate chambers should be no greater than 0.3 mm.	
Impellers	49	Should be free from physical markings except for the guide vane welds. Any additional indentations may result from: (1) Cavitation the implosion of vapor "bubbles" within the impeller stack. Make sure the Net Positive Suction Head Available for the pump meets the minimum Net Positive Suction Head Required for the pump when running at the required flow. (2) Improper coupling height. If the coupling is not set to the proper height (see step 23 of the Reassembly procedures) the impellers are not suspended as they should be, but instead they rub against the intermediate chambers, causing wear.	
Shaft	51	Smooth area should be free of fretting groove and wear. Model A bottom bearing should not show signs of wear. Model B splines should not show signs of wear.	
O-rings	57, 100, 102, 102a, 107, 109	Should be soft and pliable with no visible scars. Since they are easily damaged and fairly inexpensive, it is recommended they be replaced whenever the pump is disassembled.	
Spacers	61, 64a, 64b	Should show no signs of gouging or wear at bottom or top.	
Shaft stop ring	62	"N" Pumps and Model B Pumps Only -- Should be unblemished and fitted securely (and uniformly) in its recess area in the shaft.	
Upper seal ring	103	Should be smooth and shiny on its LOWER face with no nicks or gouges.	 
Lower seal ring	104	Should be smooth and shiny on its UPPER face with no nicks or gouges (the tapered end points downward when assembled correctly). 	 
Bellows Shaft Seal	105	Mating surfaces should show no nicks or gouges, especially the carbon rotating face. Remember, no oils of any kind can come into contact with any part of an EPDM bellows shaft seal.	

Refer to the Parts List and Kits section for a list of material numbers and spare part kits.

In the instructions that follow, the numbers in parenthesis (7) indicate the position number of that part as it is shown on the Parts List and Kits diagram.

1 NON "N" MODEL A PUMPS ONLY



Using a hammer and the Bearing Punch (material #00SV0119 for CR30s and 00SV0227 for CR60s), press the bearings (47) into the chambers (4). Be sure to use the center support base (material # 00SV0081) under the chamber to avoid damage to the guide vanes.

2





Using a hammer and the Neck Ring Punch (material #00SV0118 for CR30; 00SV0219 for CR60), press the neck rings (45) into the top of the chambers (4).

3 "N" PUMPS AND MODEL B PUMPS ONLY

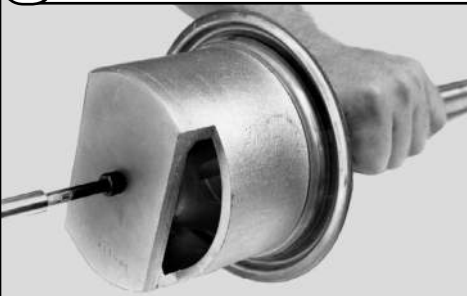

Place the bottom bearing (44) or bottom plate in the shaft holder and use a hammer and the Neck Ring Punch to press the neck ring (45) into it as well.

4 NON "N" MODEL A PUMPS ONLY







Fit the shaft (51) in the bottom bearing (44) and secure it with the set screw. Place the shaft holder (00SV0117) in a vise and tighten it.

Lubricate the threads of the split cone (49b) with an FDA-approved lubricant, such as Lard. Lower the split cone nut (48), impeller (49 and 49c), and split cone (49b) onto the shaft. Press down on the split cone nut while lifting up on the impeller to prevent the split cone from closing on the shaft.

Using the tapered end of the split cone driver (material #00SV0121) press the split cone nut and impeller down until it seats on the neck ring (45). Light taps with a hammer may be needed.

5 NON "N" MODEL A PUMPS ONLY

Flip over the split cone driver and use the other side to tighten the split cone nut (48) to 55 ft.-lbs. (75 Nm).

Fit the chamber onto the shaft. For CR60 models only, turn it counter-clockwise (when looking down on the shaft) as far as it will go, until chamber tabs touch.

6 "N" PUMPS AND MODEL B PUMPS ONLY



Tighten the Shaft Holder for Assembly (00SV0869) in a vise. Fit the shaft in the shaft holder and fit the pin through the pin hole. Fit the top chamber (3) upside down over the shaft onto the shaft holder.

7

The reassembly procedures from this point on will depend on the type of pump and the number of stages it contains. Refer to the diagrams on pages 11-16 to determine the proper sequence of stages in the pump you are working with. For Non "N" Model A pumps only, reassemble these stages in the order shown, referring to steps 4-5 for proper tightening of the split cone nuts (48).

Non "N" Model A Pumps:
When you get to the top chamber, then continue...

"N" Pumps and Model B Pumps:
After you fit the last spacer (64c), the washer (66), and the lock nut (67) -- collectively shown in the CR30 diagrams as "Part Combination F" and in the CR60 diagrams as "Part Combination D" -- then continue...

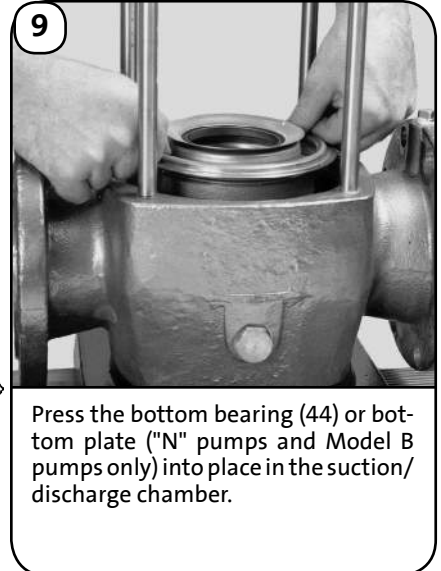
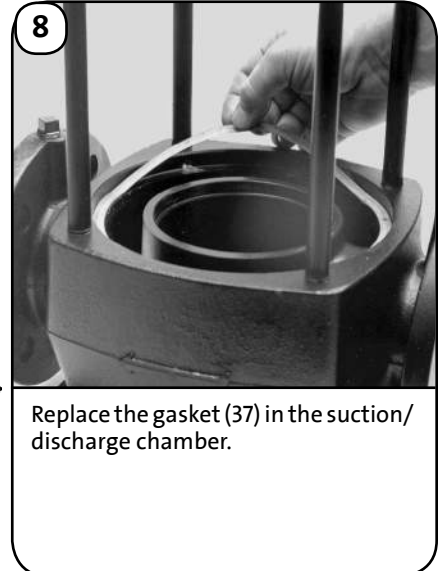

10 "N" PUMPS AND MODEL B PUMPS ONLY

<p>"N" Pumps Only: Fit the pump head cover (77) into the bottom of the motor stool. Be sure to line it up properly with the pipe plug hole.</p>	<p>Using a box wrench, tighten the lock nut to 44 ft.-lbs. (60 Nm).</p>	<p>Remove the impeller stack from the vise (and the shaft holder), flip it over, and fit it on the bottom plate (44).</p>

11 NON "N" MODEL A PUMPS ONLY

	<p>FOR CR30S WITH 1-5 STAGES (MODELS 10-50)</p> <p>If using hollow bearings: Place the driver directly down against the spacing pipe (61). Tighten the allen screws of the driver to 10 ft.-lbs. (13 Nm).</p> <p>If using solid bearings: Place the special 10.5 mm spacing tool (980440) between the bearing of the top chamber and the bottom of the driver. Tighten the allen screws of the driver to 10 ft.-lbs. (13 Nm) and remove the tool.</p> <p>FOR CR30S WITH MORE THAN 5 STAGES Do the same as above, but use a solid bearing (#340072) instead.</p> <p>FOR CR60S Do the same as above, but use the 54 mm spacing tool (00SV0347).</p>
<p>Fit the top chamber (3) over the last impeller. Fit the lower seal driver (112) onto the shaft. Examine the shaft and find the scratch marks previously made by the allen screws of the lower seal driver. Tighten the allen screws at the same position as they were before. If, however, you are using a new shaft with no previous marks, then:</p>	

The pumps can be fitted with either an o-ring seal or a bellows seal. To determine which type of seal configuration is used, read the "type" field on the pump nameplate attached to the motor stool. If the four-letter seal code (see "Reading the Pump Nameplate") begins with the letter "A," the seal is an o-ring type (e.g., AUUE). If the first letter of the seal code begins with a "B," it is a bellows type seal (e.g., BUBE). Go to step 14 for the bellows seal, or step 15 for the o-ring seal. Non "N" (Model A) pumps and pumps with six stages or more must use O-ring seal.

For Bellows Option, skip to Step 14

12 "N" PUMPS AND MODEL B PUMPS ONLY



CRN30/CRN60 and all Model B Pumps: Fit the lower seal driver (112) on top of the spacer (61a) and onto the shaft. Tighten the allen screws to 10 ft.-lbs (13 Nm).

13 NON "N" MODEL A PUMPS ONLY



Remove the entire assembly from the vise. Remove the shaft holder from the impeller stack by removing the set screw at the bottom. Set the impeller stack onto the suction/discharge chamber (6). Make sure it is firmly seated in place.

14 BELLOWS OPTION FOR "N" MODEL PUMPS AND ALL MODEL B PUMPS WITH 5 STAGES OR LESS

Non "N" Model A Pumps and Pumps with Six Stages or More Use O-Ring Seal

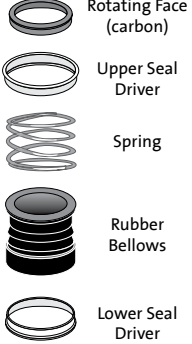

(a) Coat the inside of the bellows seal assembly with soapy water--no oils or grease may be used.
 (b) Fit the rotating bellows seal assembly onto the pump shaft and push it down (**do not twist**) until it comes into contact with the top spacer (pos. 61 or 61a).
 (c) Skip to step 15d.

15 O-RING SEAL

LOWER COMPONENTS OF SEAL ASSEMBLY



Pos. 104 Lower Seal Ring (Tapered end pointing downward)

Pos. 111 Upper Seal Driver

Pos. 107 O-Ring

Pos. 106 Cup for Spring

Pos. 108 Shaft Seal Spring

Pos. 112 Lower Seal Driver

REFER TO THE DIAGRAM ON THE LEFT AND:

(a) Press the spring (108) and spring cup (106) onto the shaft.

(b) Moisten the O-ring (107) with soapy water and push it onto the shaft down to the spring cup. Be careful not to damage it as it passes over the shaft pin hole.

(c) Fit the upper seal driver (111) and lower seal ring (104) onto the shaft. The tapered end of the seal ring should be pointed downwards.

(d) Fit the outer sleeve (55) onto the suction/discharge chamber. Replace the outer sleeve gasket (37).

16



Fit the motor stool over the staybolts. Spray the four staybolt nuts with food machinery oil (or similar oil) and tighten them diagonally to:

M16...75 ft.-lbs. (100 Nm)
M18...100 ft.-lbs. (138 Nm)

Diagonal tightening (overhead view)



17 BELLOWS OPTION FOR "N" MODEL PUMPS AND ALL MODEL B PUMPS WITH 5 STAGES OR LESS

Non "N" Model A Pumps and Pumps with Six Stages or More Use O-Ring Seal

(a) Fit the secondary seal snugly over the stationary seat.

(b) Lubricate the top of the secondary seal with soapy water and press it onto the bottom seal carrier.

(c) Skip to step 21.

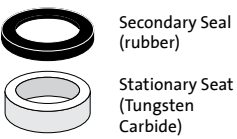

Secondary Seal (rubber)

Stationary Seat (Tungsten Carbide)

18 NON "N" MODEL A PUMPS ONLY



Press the larger O-ring (109) over the bottom of the seal carrier (58). Press the smaller O-ring (102) and upper seal ring (103) into the bottom seal carrier (tapered end pointing upwards **at this point of assembly**).

UPPER COMPONENTS OF MECHANICAL SEAL ASSEMBLY

NON "N" MODEL A PUMPS

Pos. 102 O-Ring

Pos. 103 Upper Seal Ring

Side View

"N" PUMPS AND MODEL B

Pos. 102 O-Ring

Pos. 103a Retainer For Upper Seal Ring

Side View

Pos. 102a O-Ring

Pos. 103 Upper Seal Ring

Side View

19 "N" PUMPS AND MODEL B PUMPS ONLY

Place large O-ring (109) in groove of seal carrier (58). Place O-ring (102) over retainer for upper seal ring (103a). Press into seal carrier (58). Place O-ring (102a) into retainer. Lubricate/spray 5% soapy water solution. Press upper seal ring (103) (polished surface pointing upwards) into O-ring (102a) in retainer.

20 NON "N" MODEL A PUMPS ONLY

Replace the disc (59) and press it down against the upper seal ring and O-rings so they mesh and the screw holes are aligned. Replace and tighten the screws to 8 ft.-lbs. (10 Nm). Lubricate the bottom of the disc with an FDA-approved lubricant or soapy water.

21

Place the seal carrier assembly onto the shaft. The tapered ends of the seal ring(s) should now be pointing down.

Using an allen wrench, tighten the screws in the seal carrier diagonally to 8 ft.-lbs. (10 Nm).

Order of tightening (overhead view)

22

Fit the motor onto the motor stool (2) and turn it so the terminal box is pointing in the direction you wish. Lubricate the motor bolts (28) with food machinery oil and tighten them to 30 ft.-lbs. (41 Nm).

Diagonal tightening (overhead view)

23

Fit the shaft pin (10) into the hole at the end of the shaft. Fit the two coupling halves (10a) and hand tighten the allen screws into the coupling. Make sure the gaps on either side of the coupling are even.

24 SETTING THE COUPLING HEIGHT

- Note the clearance below the coupling
- Raise the coupling up as far as it will go
- Lower it halfway back down (½ the distance you just raised it)
- Tighten screws to 46 ft.-lbs. (62 Nm)

With a screwdriver in one hand and allen wrench in the other, raise the coupling (with the screwdriver) as high as it will go. Make sure the shaft moves with the coupling (there will be some "play" as the shaft pin moves within the coupling). Lower it halfway back down the distance you raised it. Tighten the allen screws two and two (one side at a time). Make sure the gaps on either side of the coupling are even. Turn the coupling by hand (it should rotate freely). If the shaft is tight or won't rotate at all, there is a problem (e.g., missing spacer, wrong parts, etc.).

25

Using a screwdriver, spring the two coupling guards (7) into place. For solid type guards, hold guard in place, reinstall screws (7a) and torque to 2 ft.-lbs. or 2.5 Nm.

THE PUMP IS NOW COMPLETELY DISASSEMBLED.

Order of Stage Assembly

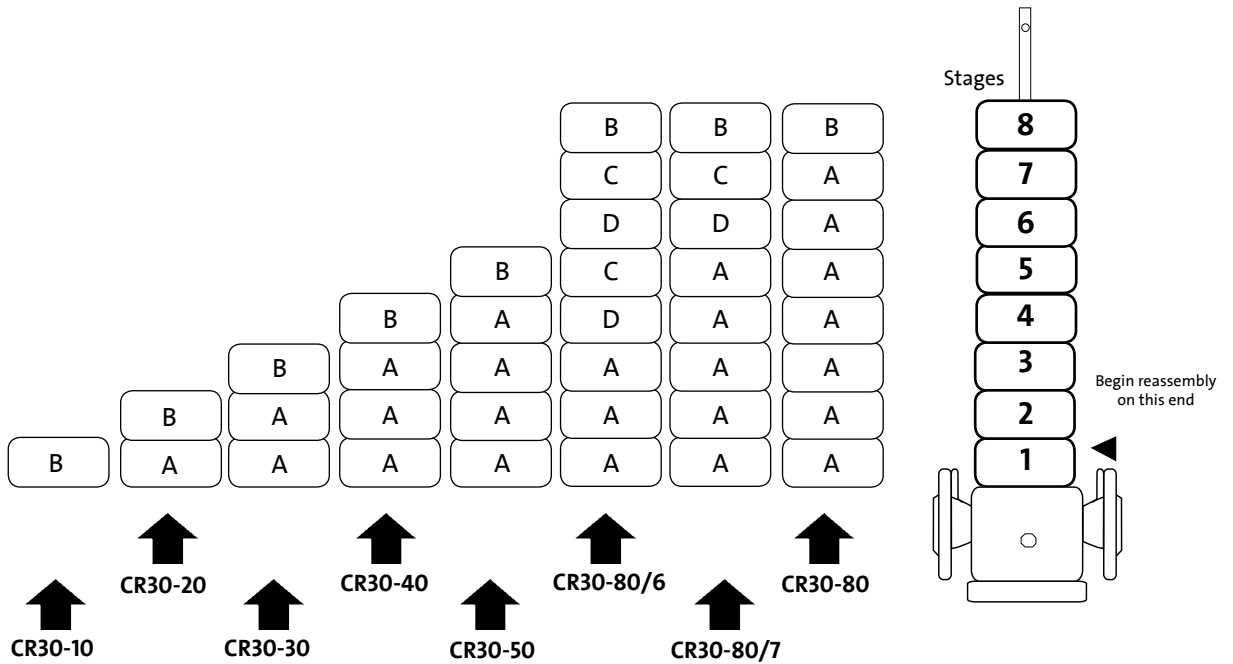
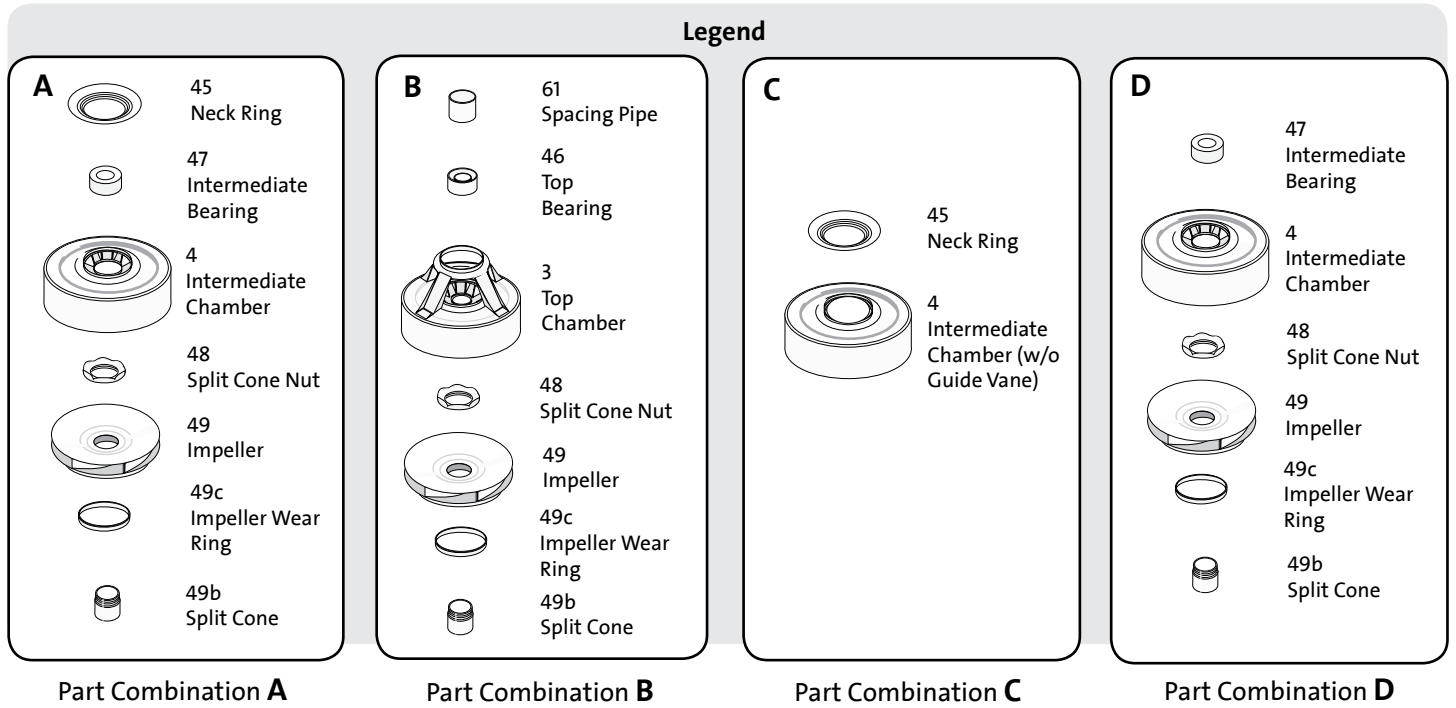

**This order of assembly applies to
Model A CR30 pumps
(pumps with date code prior to 9106)**

Reassembly Procedures CR30 Model B (Spline Shaft)

Order of Stage Assembly

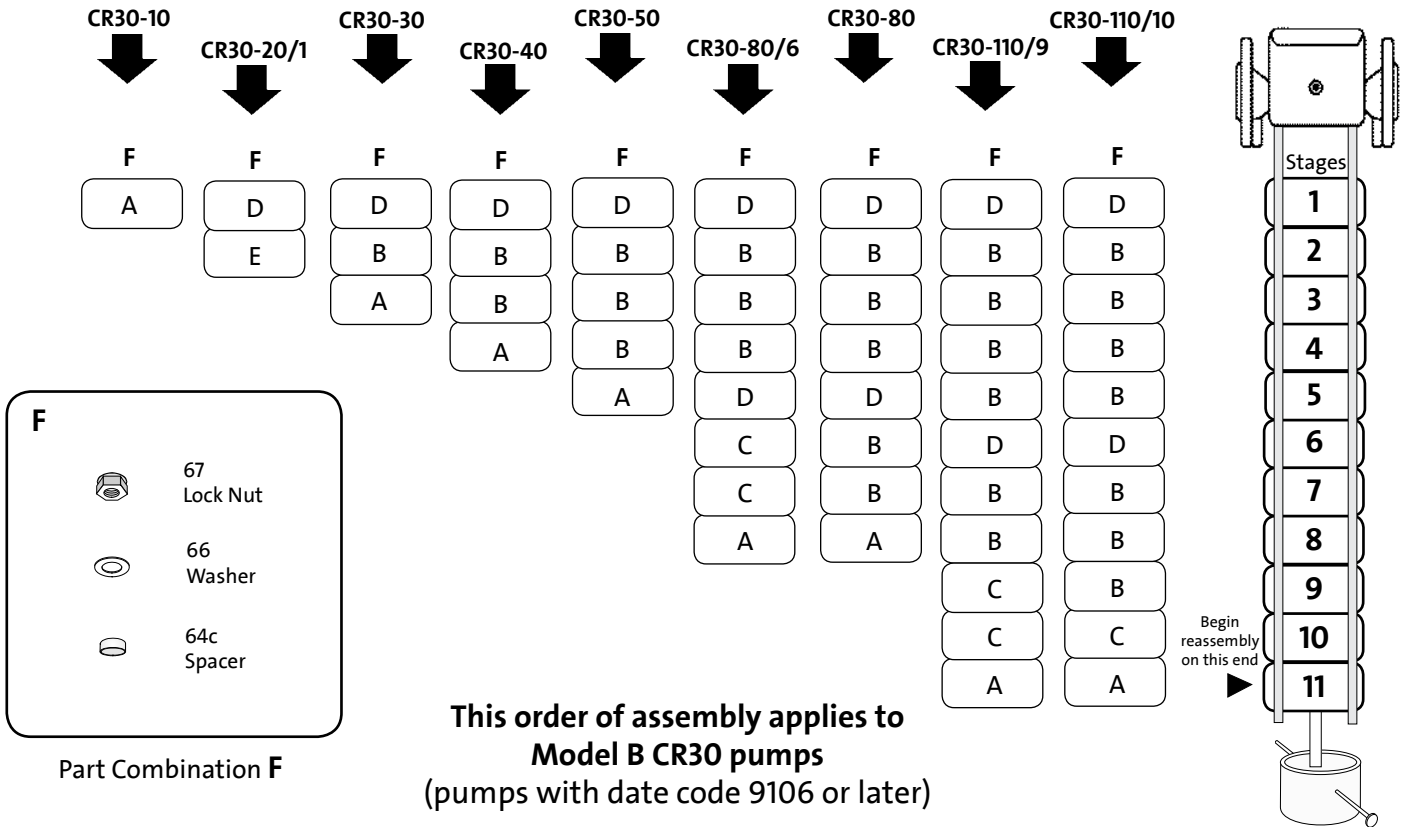
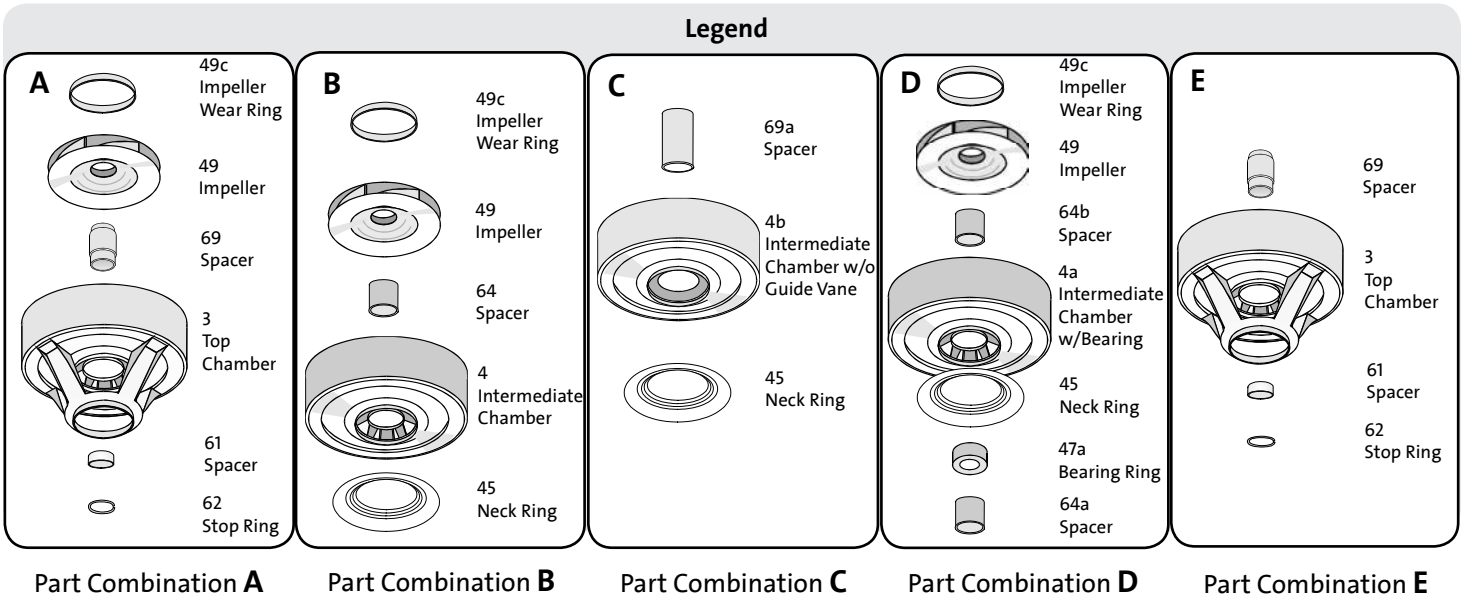

NOTE: Since proper reassembly of the impeller stages must be done "upside down," this chart has been arranged that way for your convenience.

Order of Stage Assembly

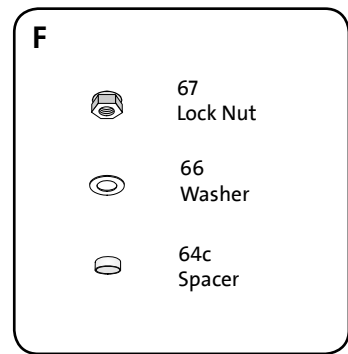
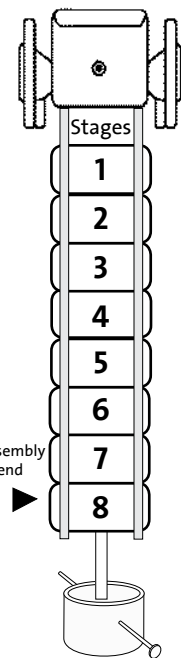
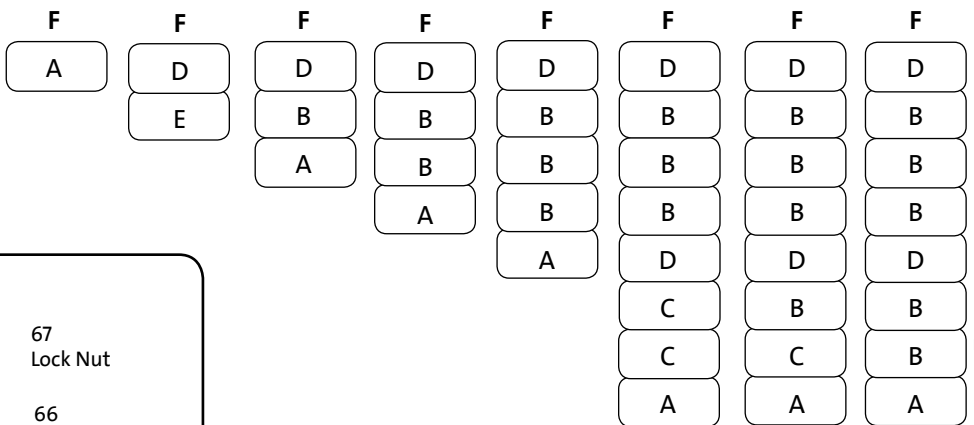
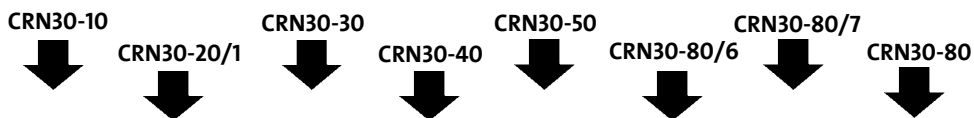
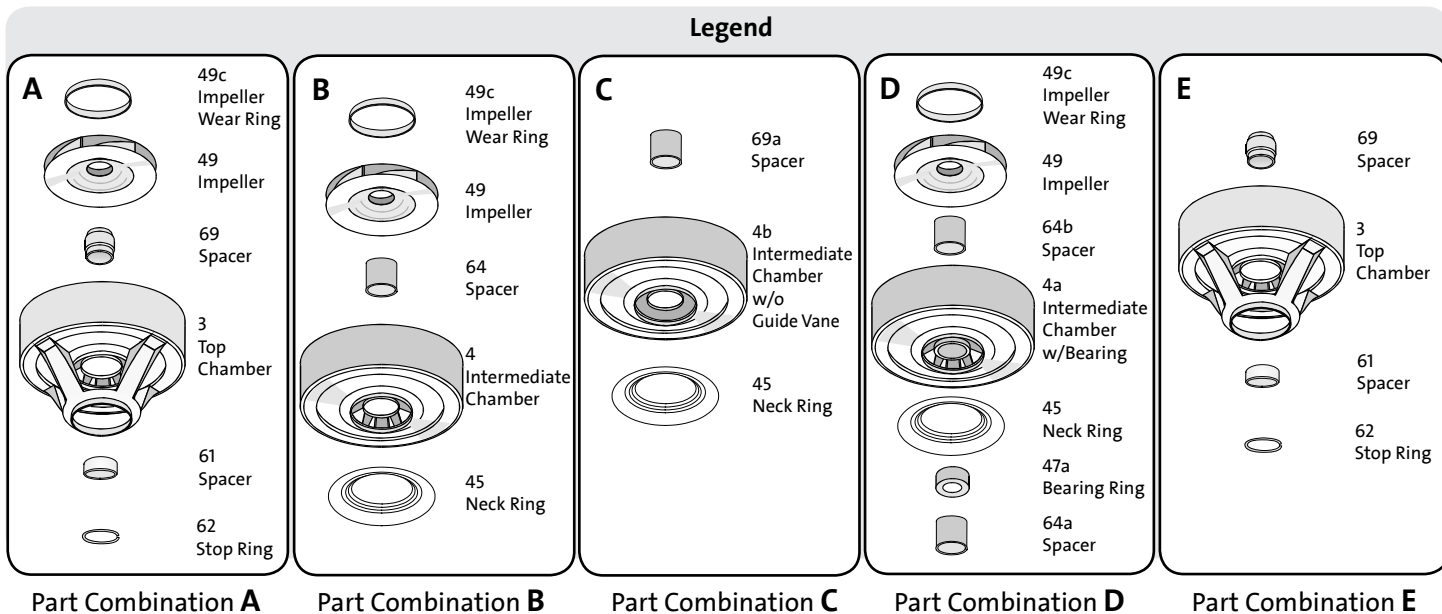

Part Combination F

NOTE: Since proper reassembly of the impeller stages must be done "upside down," this chart has been arranged that way for your convenience.

Order of Stage Assembly

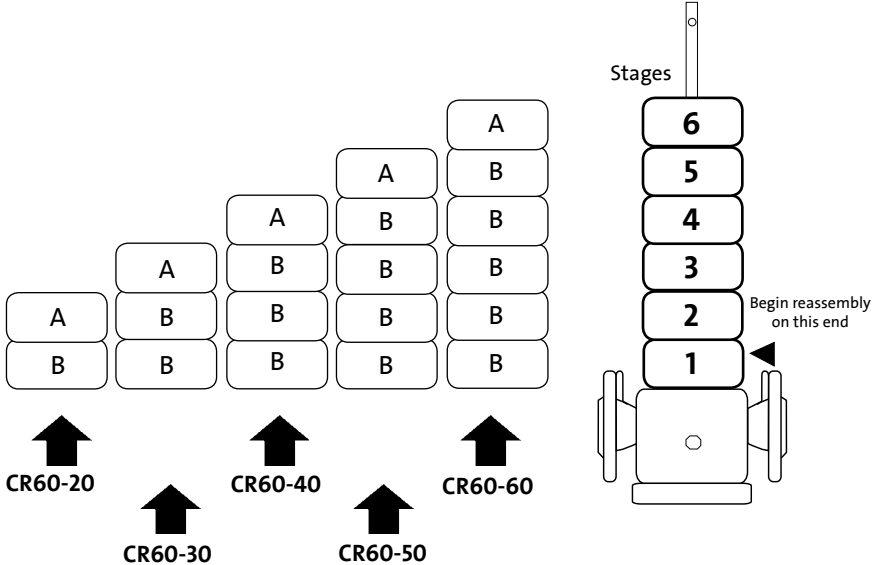
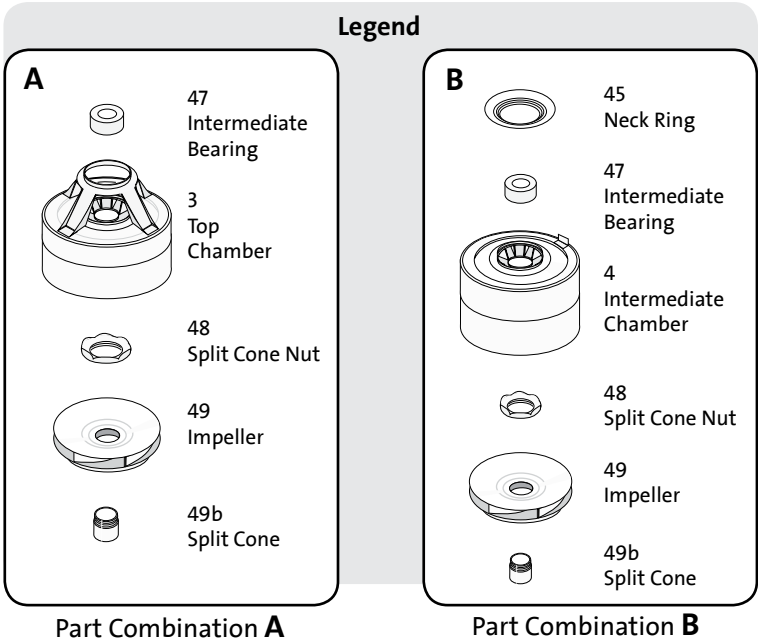

**This order of assembly applies to
Model A CR60 pumps**

Order of Stage Assembly

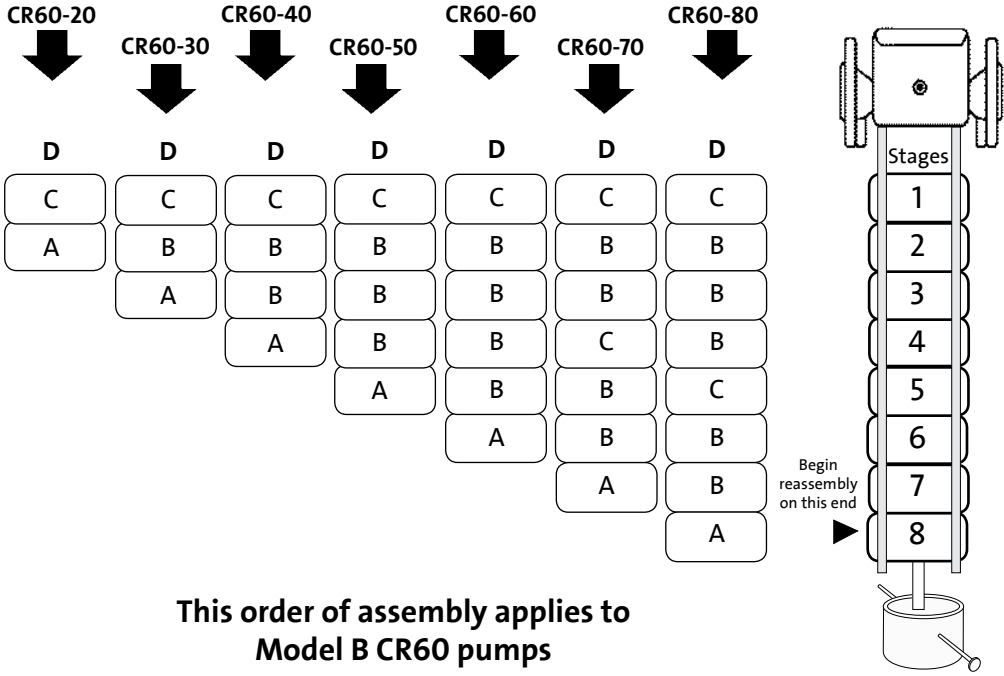
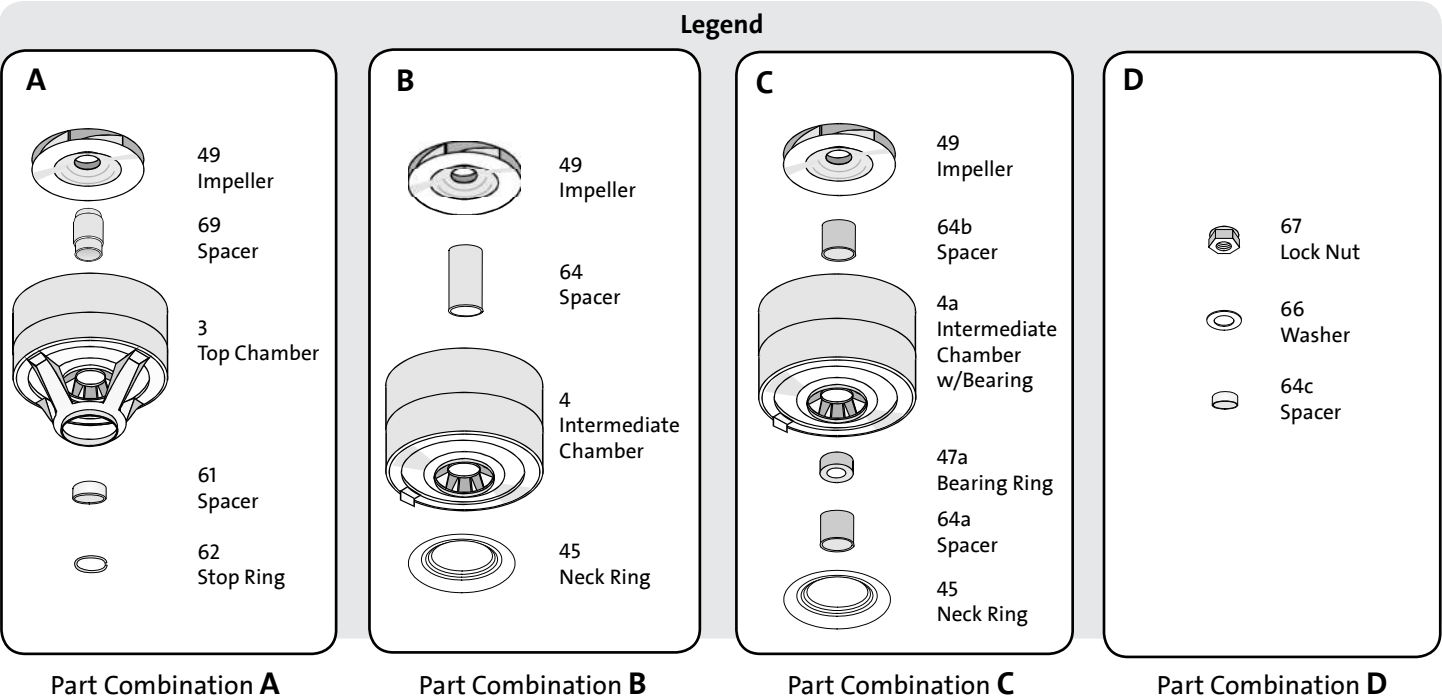

NOTE: Since proper reassembly of the impeller stages must be done "upside down," this chart has been arranged that way for your convenience.

Order of Stage Assembly • CRN60

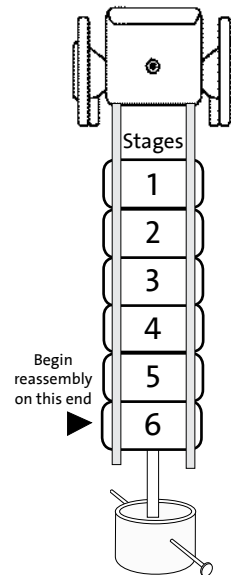
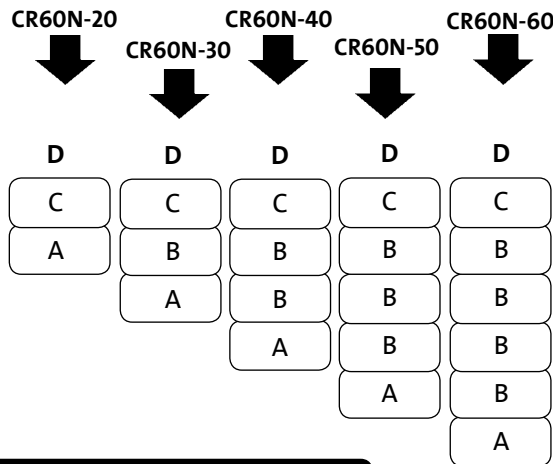
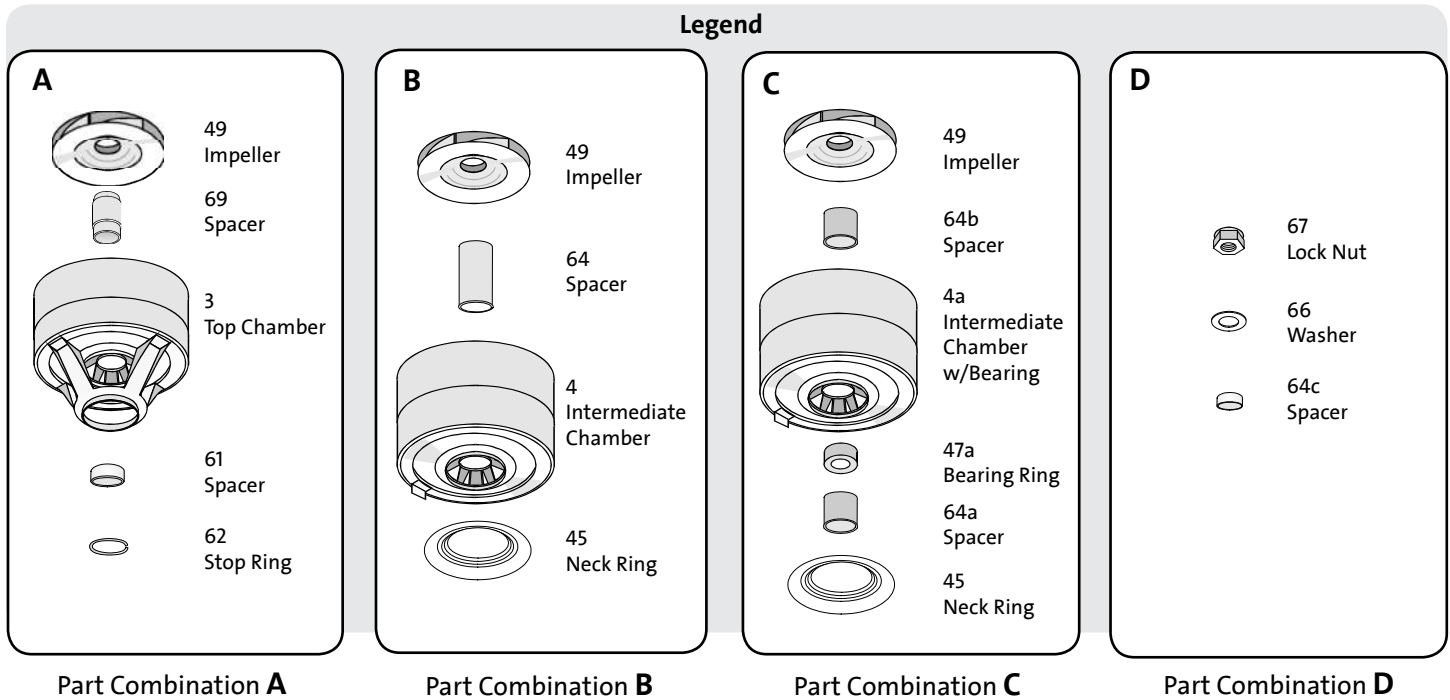

NOTE: Since proper reassembly of the impeller stages must be done "upside down," this chart has been arranged that way for your convenience.

SM-DR-C3060 0503

The name Grundfos, the Grundfos logo, and be think innovate are registered trademarks owned by Grundfos Holding A/S, Denmark. All rights reserved worldwide. © Copyright Grundfos Holding A/S

GRUNDFOS Pumps Corporation
17100 W. 118th Terrace
Olathe, Kansas 66062
Phone: 913.227.3400
Fax: 913.227.3500
www.grundfos.us

GRUNDFOS Canada, Inc.
2941 Brighton Road
Oakville, Ontario L6H 6C9 Canada
Phone: 905.829.9533
Fax: 905.829.9512

Bombas GRUNDFOS de Mexico S.A. de C.V.
Boulevard TLC No. 15
Parque Industrial Stiva Aeropuerto
Apodaca, N.L. Mexico 66600
Phone: 52.81.8144.4000
Fax: 52.81.8144.4010

GRUNDFOS 