

Hydro MPC

Installation and operating instructions



WATER QUALITY

Drinking Water System Component
NSF / ANSI 61
NSF / ANSI 372

be
think
innovate

GRUNDFOS 

English (US) Installation and operating instructions

Original installation and operating instructions

These installation and operating instructions apply to the Grundfos Hydro MPC pump system.

Sections 1-5 give the information necessary to be able to install the product in a safe way.

Sections 6-16 give important information about the product as well as information on service and fault finding.

CONTENTS

	Page
1. Limited Warranty	2
2. Symbols used in this document	3
2.1 Warnings against hazards involving risk of death or personal injury	3
2.2 Other important notes	3
3. Receiving the product	3
3.1 Transporting the product	3
4. Installing the product	3
4.1 Location	3
4.2 Mechanical installation	3
4.3 Electrical installation	5
5. Starting up the product	6
5.1 Handling the product	8
5.2 Handling the product	8
6. Product introduction	9
6.1 Product description for CR, CRE, CRI, CRIE	9
6.2 Control variant	9
6.3 Product description for Hydro MPC CME	10
6.4 Identification	10
6.5 Type key	11
7. Overview of control variants	12
8. Operating panel	13
8.1 Display	13
8.2 Buttons and indicator lights	14
9. Functions	15
9.1 Tree of functions	15
9.2 Overview	17
9.3 Description of functions	19
9.4 Status (1)	19
9.5 Operation (2)	23
9.6 Alarm (3)	28
9.7 Settings (4)	31
9.8 Data communication	71
10. Servicing the product	73
10.1 Maintaining the product	73
11. Protecting the product against frost	73
12. Taking the product out of operation	73
13. Fault finding	74
14. Technical data	75
14.1 Pressure	75
14.2 Temperatures	75
14.3 Relative humidity	75
14.4 Sound pressure level	75
14.5 Electrical data	75
15. Related documents	76
16. Disposing of the product	76



Read this document before you install the product. Installation and operation must comply with local regulations and accepted codes of good practice.

1. Limited Warranty

Products manufactured by GRUNDFOS PUMPS CORPORATION (Grundfos) are warranted to the original user only to be free of defects in material and workmanship for a period of 24 months from date of installation, but not more than 30 months from date of manufacture. Grundfos' liability under this warranty shall be limited to repairing or replacing at Grundfos' option, without charge, F.O.B. Grundfos' factory or authorized service station, any product of Grundfos' manufacture. Grundfos will not be liable for any costs of removal, installation, transportation, or any other charges which may arise in connection with a warranty claim. Products which are sold but not manufactured by Grundfos are subject to the warranty provided by the manufacturer of said products and not by Grundfos' warranty. Grundfos will not be liable for damage or wear to products caused by abnormal operating conditions, accident, abuse, misuse, unauthorized alteration or repair, or if the product was not installed in accordance with Grundfos' printed installation and operating instructions.

To obtain service under this warranty, the defective product must be returned to the distributor or dealer of Grundfos' products from which it was purchased together with proof of purchase and installation date, failure date, and supporting installation data. Unless otherwise provided, the distributor or dealer will contact Grundfos or an authorized service station for instructions. Any defective product to be returned to Grundfos or a service station must be sent freight prepaid; documentation supporting the warranty claim and/or a Return Material Authorization must be included if so instructed.

GRUNDFOS WILL NOT BE LIABLE FOR ANY INCIDENTAL OR CONSEQUENTIAL DAMAGES, LOSSES, OR EXPENSES ARISING FROM INSTALLATION, USE, OR ANY OTHER CAUSES. THERE ARE NO EXPRESS OR IMPLIED WARRANTIES, INCLUDING MERCHANTABILITY OR FITNESS FOR A PARTICULAR PURPOSE, WHICH EXTEND BEYOND THOSE WARRANTIES DESCRIBED OR REFERRED TO ABOVE.

Some jurisdictions do not allow the exclusion or limitation of incidental or consequential damages and some jurisdictions do not allow limit actions on how long implied warranties may last. Therefore, the above limitations or exclusions may not apply to you. This warranty gives you specific legal rights and you may also have other rights which vary from jurisdiction to jurisdiction.

2. Symbols used in this document

2.1 Warnings against hazards involving risk of death or personal injury



DANGER

Indicates a hazardous situation which, if not avoided, will result in death or serious personal injury.



WARNING

Indicates a hazardous situation which, if not avoided, could result in death or serious personal injury.



CAUTION

Indicates a hazardous situation which, if not avoided, could result in minor or moderate personal injury.



SIGNAL WORD

Description of hazard

Consequence of ignoring the warning.
- Action to avoid the hazard.

2.2 Other important notes



A blue or grey circle with a white graphical symbol indicates that an action must be taken.



A red or grey circle with a diagonal bar, possibly with a black graphical symbol, indicates that an action must not be taken or must be stopped.



If these instructions are not observed, it may result in malfunction or damage to the equipment.



Tips and advice that make the work easier.

3. Receiving the product

3.1 Transporting the product

Depending on the size, the pump system is delivered in an open wooden box or wooden or cardboard box designed for transport by forklift truck or a similar vehicle.

The forks of the forklift truck must be at least 6.6 ft (2 m) long.



The Hydro MPC pump systems with CR 125 or CR 155 pumps are secured by means of transport straps. Do not remove these transport straps until the pump system has been installed.

4. Installing the product

Before installing the product, check the following:

- The pump system corresponds to the order.
- All visible parts are intact.

4.1 Location

Install the pump system in a well-ventilated room to ensure sufficient cooling of the control cabinet and pumps.



Hydro MPC is only designed for indoor installation. Do not expose the product to direct sunlight.

Place the pump system with a 3.3 ft (1 m) clearance in front and on the two sides for inspection and removal.

4.2 Mechanical installation

4.2.1 Pipes

Arrows on the pump base show the direction of flow of water through the pump.

The pipes connected to the pump system must be of adequate size.

Connect the pipes to the manifolds of the pump system. Either end can be used. Apply sealing compound to the unused end of the manifold, and fit the screw cap. For manifolds with flanges, fit a blanking flange with gasket.

To achieve optimum operation and minimize noise and vibration, it may be necessary to consider vibration dampening of the pump system.

Noise and vibration are generated by the rotations in the motor and pump and by the flow in pipes and fittings. The effect on the environment is subjective and depends on correct installation and the state of the other parts of the system.

If pump systems are installed in blocks of flats or the first consumer on the line is close to the pump system, we recommend that you fit expansion joints on the inlet and outlet pipes to prevent that vibrations are transmitted through the pipes.

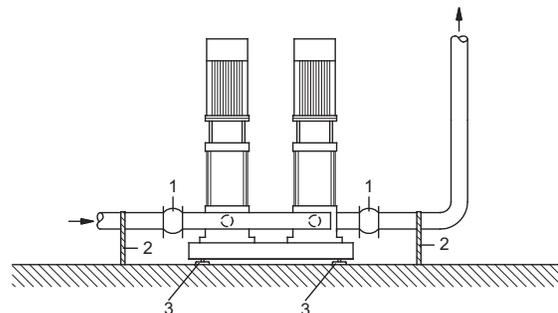
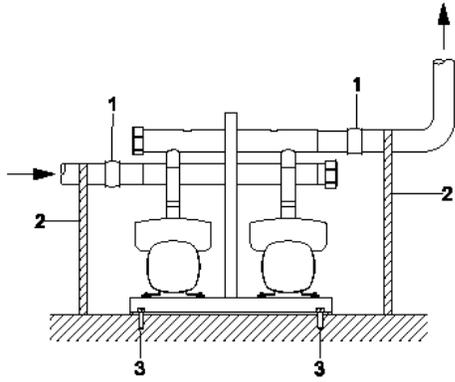

Fig. 1 Example showing the position of expansion joints, pipe supports and machine shoes

Pos.	Description
1	Expansion joint (and good location for isolating valves)
2	Pipe support
3	Machine shoe

TM03 2154 3805



TM04 9900 0211

Fig. 2 Example showing the position of expansion joints, pipe supports and mounting bolts

Pos.	Description
1	Expansion joint (and good location for isolating valves)
2	Pipe support
3	Mounting bolt



Expansion joints, pipe supports and machine shoes shown in figs. 1 and figs. 2, respectively, are not included in a standard pump system.

Tighten all nuts before startup.

Fasten the pipes to parts of the building to ensure that they cannot move or be twisted.

4.2.2 Foundation

We recommend that you install the pump system on a plane and rigid concrete foundation which is heavy enough to provide permanent support for the entire system. The foundation must be capable of absorbing any vibration, normal strain or shock.



The weight of a concrete foundation must be 1.5 times the weight of the pump system.

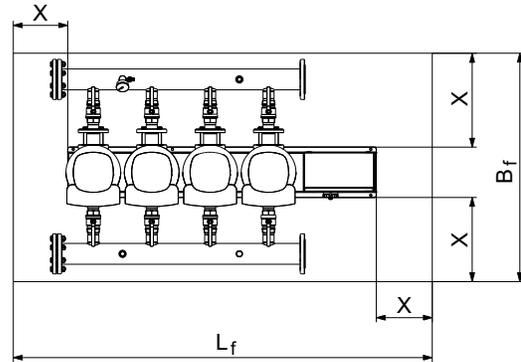
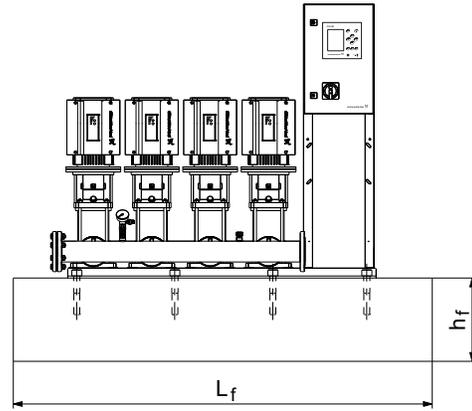

TM06 9269 0517

Fig. 3 Foundation

The minimum height of the foundation, h_f , is calculated as follows:

$$h_f = \frac{W_{\text{pump}} \times 1.5}{L_f \times B_f \times \delta_{\text{concrete}}}$$

The density δ of concrete is usually taken as 137 lb/ft³ (2200 kg/m³).

Variable	Unit
h_f	ft
W_{pump}	lb
L_f	ft
B_f	ft
δ_{concrete}	lb/ft ³

4.2.3 Vibration dampers

To prevent the transmission of vibrations to buildings, we recommend that you isolate the pump system foundation from building parts by means of vibration dampers.

The right damper varies from installation to installation, and a wrong damper may increase the vibration level. Vibration dampers must therefore be sized by the supplier. If the pump system is installed on a base frame with vibration dampers, always fit expansion joints on the manifolds. This is important to prevent the pump system from "hanging" in the pipes.

4.2.4 Expansion joints

Fit expansion joints for these reasons:

- to absorb expansions or contractions in the pipes caused by changing liquid temperature
- to reduce mechanical strains in connection with pressure surges in the pipes
- to isolate mechanical structure-borne noise in the pipes (only rubber bellows expansion joints).



Do not install expansion joints to compensate for inaccuracies in the pipes such as center displacement of flanges.

Fit expansion joints at a distance of minimum 1 to 1 1/2 times the nominal flange diameter from the manifold on the inlet as well as on the outlet side. This prevents the development of turbulence in the expansion joints, resulting in better inlet conditions and a minimum pressure loss on the pressure side.

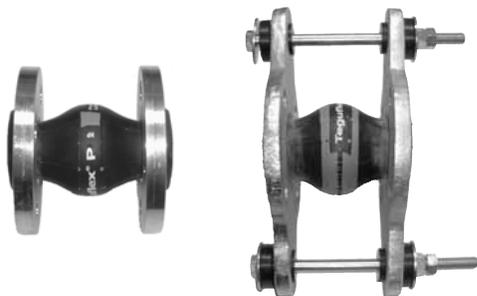

TM02 4981 1902 - TM02 4979 1902

Fig. 4 Examples of rubber bellows expansion joints without and with limiting rods

Expansion joints with limiting rods can be used to minimize the forces caused by the expansion joints. We always recommend that you use expansion joints with limiting rods for flanges larger than ANSI 4" (DN 100).

Anchor the pipes so that they do not stress the expansion joints and the pump. Follow the supplier's instructions and pass them on to advisers or pipe installers.

4.2.5 Prefilling of diaphragm tank, if applicable

If a diaphragm tank is connected to the system, prefill the tank with nitrogen to this pressure:

- 0.7 x the setpoint (Hydro MPC-E and F-systems)
- 0.9 x the setpoint (Hydro MPC-S systems).



Use nitrogen to avoid corrosion.

4.3 Electrical installation

CAUTION

Electric shock



Minor or moderate personal injury

- The electrical installation must be carried out by an approved person in accordance with local regulations and the relevant wiring diagram.
- Switch off the power supply and lock the main switch with a padlock to ensure that the power supply cannot be accidentally switched on.

- The electrical installation of the pump system must comply with enclosure class UL type 3R.
- Check that the power supply and frequency correspond to the values stated on the nameplate.
- Make sure that the conductor cross-section meets the specifications in the wiring diagram.



The connection of the electrical supply, transmitters and external monitoring equipment must be carried out by an authorized electrician in accordance with the NEC, local regulations and the Hydro MPC wiring diagram.



Ensure that the Hydro MPC controls and the pumps are suitable for the electricity supply on which they will be used. See section 14. *Technical data*. Please read the wiring diagram carefully. According to the NEC, if the motors cannot be seen from the control panel, they must be fitted with a disconnect switch.



Any Hydro MPC that utilizes a variable frequency drive (E, ED, ES, EF, EDF, F) must be connected to an electrical supply with all phase lines electrically symmetrical with respect to ground. Grundfos recommend a four-wire wye electrical supply with line impedance between 0.5 - 3 %. If a variable frequency drive is connected to a delta transformer or if line impedance is not within the recommended 0.5 - 3 %, the drive may not operate correctly and may not provide optimum performance (excessive faults, erratic behavior, or complete failure). Grundfos does not recommend open delta power. Ask your power company or electrician to determine what type of electrical supply is present. Generator supplied power must meet public utility power quality standards.

5. Starting up the product

After having carried out the mechanical and electrical installation described in sections [4.2 Mechanical installation](#) and [4.3 Electrical installation](#), proceed as follows:

1. Have a qualified person check for proper power supply and plumbing connections. Make sure the main power is off.
2. Check that the precharge pressure in the diaphragm tank is 0.7 times the required outlet pressure (setpoint). System pressure must not be applied to the tank connection during the tank precharge process. If water is supplied to the tank from the system, close the tank valve and bleed off the pressure in the tank before the pressurizing process.
3. Prime the system as follows:
 - "Flooded inlet system" (pumps are flooded at least as high as the highest part of the pumps)
 - Close all outlet manifold pump isolation valves.
 - Open all inlet manifold pump isolation valves.
 - Open the vent plug on all pumps.
 - Leave the vents open until all air is removed from the pumps and only water is flowing from the vents.
 - Close the vent plug on all pumps
 - "Suction lift system" (the water source is below the pumps or does not flood the pumps to the highest point on the pumps).



A foot valve must be placed on the inlet piping at the water source (tank, etc).



Check valves must be installed on inlet manifolds and a priming line installed from outlet to inlet manifold for proper installation.

- Close all outlet manifold pump isolation valves.
 - Open all inlet manifold pump isolation valves.
 - If there is a fill point above the highest point of the pumps, you may fill the system from this point.
 - If there is no fill point above the highest point of the pumps, remove the large vent plug on each pump. Fill each pump until the water is up to the vent plug.
 - Replace the vent plugs.
4. Ensure all circuit breakers are in the "on" position.
 5. Ensure the outlet manifold pump isolation valves are closed.
 6. Switch on the main power.



When the power is switched on the pumps may start automatically.

7. If this is the first time the system has been powered on, the "Start-up wizard" may appear. Complete the "Start-up wizard" and proceed to step 9. If the wizard does not appear, please proceed to Step 8.
8. Run the "Start-up wizard" and perform the following:
 - Move top line display to "Settings". If prompted for password, enter "1234".
 - Move down to "Functions, CU 352" and press [OK].
 - Move down to "Run wizard again" and press [OK].
9. Vent the system by opening the vent plug on each pump (as in Step 4, while the pump is running starting in step 18 of the "Start-up wizard"). Venting with the pumps running ensures all air is removed from the inlet piping. Do not run the system with the outlet manifold pump isolation valves closed more than five minutes to prevent over-heating of the pump liquid.
10. As the pumps stop, check the pump rotation. Repeat as necessary.



For better visibility remove a coupling guard. If the area is dark, a flashlight may be required.

CAUTION

Crushing of hands

- Minor or moderate personal injury
- Do not touch the couplings while the pumps are turning. Replace all coupling guards after the rotation check.
 - Disconnect the main power when removing and replacing the coupling guards



If the rotation is incorrect on any three-phase pumps, switch any 2 of the 3 power cables supplied to the control panel (L1, L2, L3). If this does not correct the rotation, contact Grundfos.

11. When you have vented the pumps and checked for correct rotation, the Hydro MPC is now ready for operation. With the outlet manifold isolation valves still closed, partially open each pump outlet isolation valve to allow water to enter into the outlet piping. Continue the process of filling the outlet piping until the outlet piping pressure is approximately at the desired setpoint pressure of the system.
12. Open pump outlet isolation valves completely. The system is now ready for operation.



It may be necessary to clear alarms in the fault log.

5.1 Handling the product

The Hydro MPC pump systems with CR 125 or 155 pumps have eyebolts in the base frame. See fig. 5.

During handling, the lifting point must always be above the center of gravity of the pump system.

Each lifting strap must be at least 10ft (3 m) long.

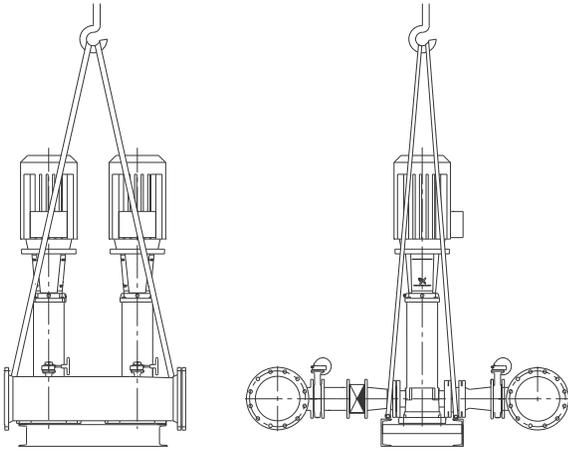

Fig. 5 Correct lifting of Hydro MPC XL

TM06 9993 3417

5.2 Handling the product

Lift the pump systems with CM and CME pumps as shown in fig. 6.

During handling, the lifting point must always be above the center of gravity of the pump system.

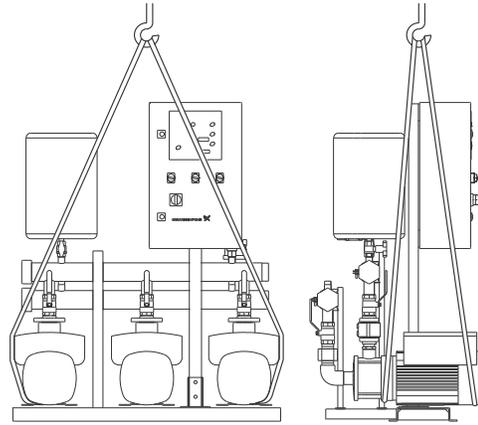

Fig. 6 Correct lifting of Hydro MPC CME with CM and CME pumps

TM05 0221 0911

CAUTION

Overhead load



- Minor or moderate personal injury
- When lifting the pump system, do not use the eyebolts of the motors.
 - Do not lift the pump system by the manifolds.
 - Do not stand on the manifolds.

CAUTION

Crushing of feet



- Minor or moderate personal injury
- When lifting the pump system, do not use the eyebolts of the motors.
 - Do not lift the pump system by the manifolds.
 - Do not stand on the manifolds.

When lifting the pump system, only use suitable lifting equipment that is in good condition and approved for the weight. The weight is stated on the nameplate of the pump system.



Do not use chains for lifting pump systems with CR 125 or CR 155 pumps, as this may damage the motors.

CAUTION

Overhead load



- Minor or moderate personal injury
- When lifting the pump system, do not use the eyebolts of the motors.
 - Do not lift the pump system by the manifolds.
 - Do not stand on the manifolds.

CAUTION

Crushing of feet



- Minor or moderate personal injury
- When lifting the pump system, do not use the eyebolts of the motors.
 - Do not lift the pump system by the manifolds.
 - Do not stand on the manifolds.

When lifting the pump system, only use suitable lifting equipment that is in good condition and approved for the weight. The weight is stated on the nameplate of the pump system.

6. Product introduction

6.1 Product description for CR, CRE, CRI, CRIE

As standard, the pump systems consist of two to six CRI(E) or CR(E) pumps connected in parallel and mounted on a common base frame with a control cabinet and all necessary fittings.



A diaphragm tank must be included in some installations.

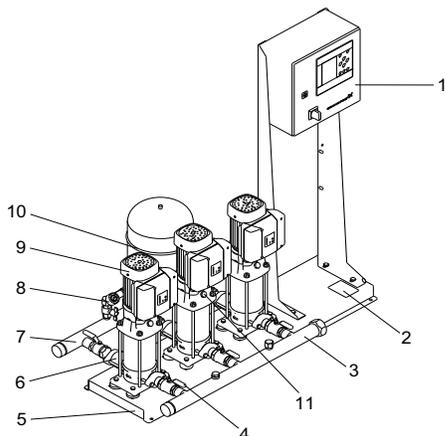

TM04 4110 0709

Fig. 7 Hydro MPC pump system

Pos.	Description	Quantity
1	Control cabinet	1
2	Nameplate	1
3	Inlet manifold, stainless steel	1
4	Isolating valve	2 per pump
5	Base frame, stainless steel	1
6	Non-return valve	1 per pump
7	Outlet manifold, stainless steel	1
8	Pressure transmitter and pressure gauge	1
9	Pump	2-6
10	Diaphragm tank	1
11	Vent plug	1 per pump

6.2 Control variant

The Hydro MPC pump systems are divided into three groups based on the control variant:

Control variant	Description
-E	Two to six electronically speed-controlled pumps. From 0.5 to 30 hp (0.37 to 22 kW), Hydro MPC-E is equipped with CRE pumps with integrated frequency converter. As from 40 hp (30 kW), Hydro MPC-E is equipped with CR pumps connected to Grundfos CUE frequency converters (one per pump).
-F	Two to six CR(I) pumps connected to a Grundfos CUE frequency converter. The speed-controlled operation alternates between the pumps.
-S	Two to six mains-operated CR(I) pumps

Design code E-I only uses CR pumps connected to Grundfos CUE frequency converters (one per pump).

See also section [7. Overview of control variants](#).

Hydro MPC always include application-optimized software for setting the pump system to the application in question.

6.3 Product description for Hydro MPC CME

Hydro MPC CME is a range of factory-assembled pump systems, ready for installation and operation.

As standard, the pump systems consist of two and three pumps connected in parallel and mounted on a common base frame with a control cabinet and all necessary fittings.

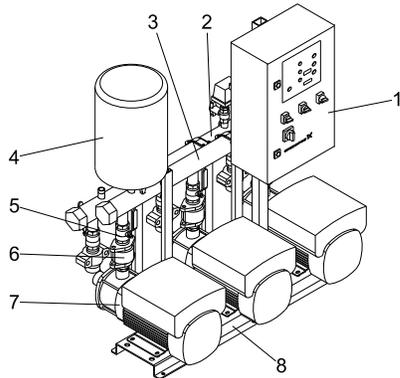

Fig. 8 Front view of Hydro MPC CME pump system with three CM(E) pumps

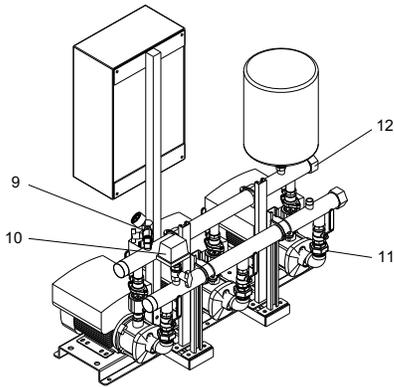

Fig. 9 Rear view of Hydro MPC CME pump system with three CM(E) pumps

Pos.	Description	Quantity
1	Control cabinet	1
2	Inlet manifold	1
3	Outlet manifold	1
4	Diaphragm tank (not included)	1
5	Isolating valve	2 per pump
6	Non-return valve	1 per pump
7	Pump	2-4
8	Base frame	1
9	Pressure transmitter and pressure gauge	1
10	Pressure switch or inlet pressure sensor	1
11	Oval flange (CME 3-10)	2 per pump
	Intermediate adapter (CME 15-25)	1 per pump
12	Screw cap or blanking flange	2

6.4 Identification

6.4.1 Nameplate

The nameplate of the pump system is fitted on the base frame. See position 2 in fig. 10.

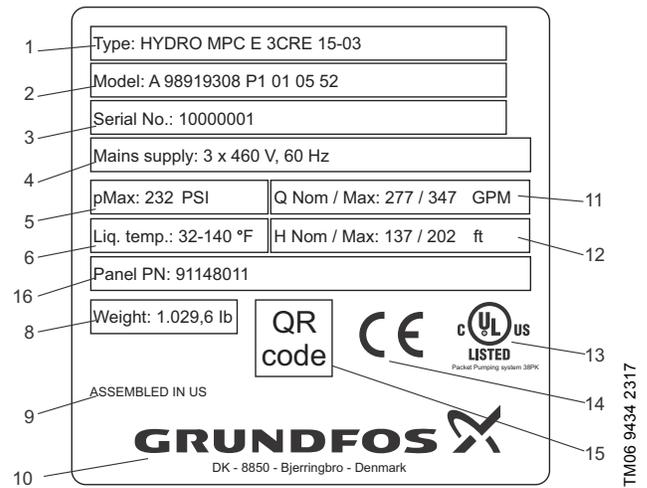
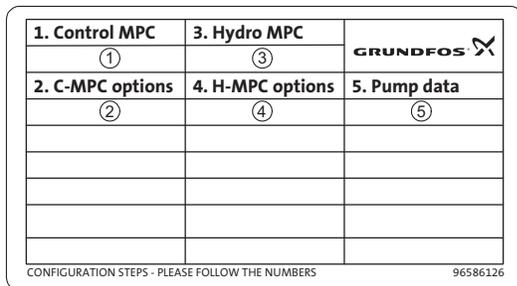

Fig. 10 Nameplate

Pos.	Description
1	Type designation
2	Model
3	Serial number
4	Supply voltage
5	Maximum operating pressure in PSI
6	Liquid temperature
7	Enclosure class
8	Weight in lb
9	Country of origin
10	Company logo
11	Maximum flow rate in GPM
12	Nominal head in ft
13	Approval mark
14	Approval mark
15	QR code
16	Panel part number

6.4.2 Software label

The software label is placed on the back of the CU 352 control unit.



TM03 1742 3105

Fig. 11 Software label

Pos.	Description
1	Control MPC - GSC file number
2	Control MPC options - GSC file numbers
3	Hydro MPC - GSC file number*
4	Hydro MPC options - GSC file numbers*
5	Pump data - GSC file numbers**

* Applies only to pump systems.

** Applies only to CR and CRE pumps.



A GSC (Grundfos Standard Configuration) file is a configuration data file.

6.5 Type key

Code	Example	Hydro MPC	-E	3 CRE 15-03	3 x 460 V, 60 Hz
Type range					
System type					
E	All pumps, E-motor or CUE				
F	Fixed-speed pumps, one CUE				
S	Fixed-speed pumps				
X	Customized-system pumps				
Number of pumps with integrated frequency drive and pump type					
Number of fixed speed pumps and pump type					
Supply voltage, frequency					

* The control cabinet can be placed up to 6.6 ft (2 m) from the pumps.

7. Overview of control variants

The table shows examples of systems.

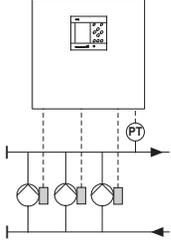
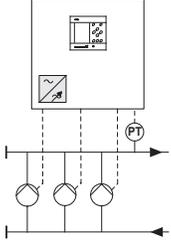
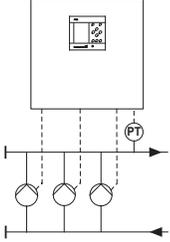
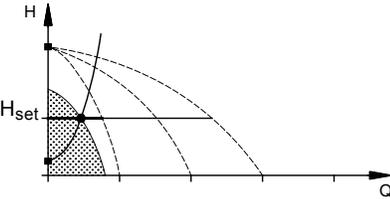
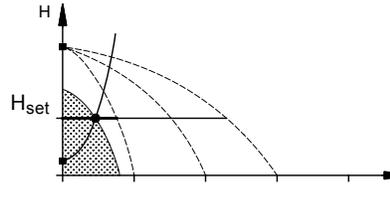
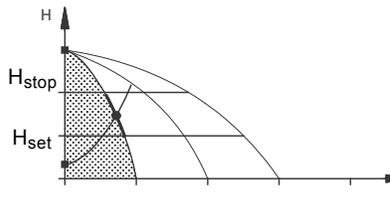
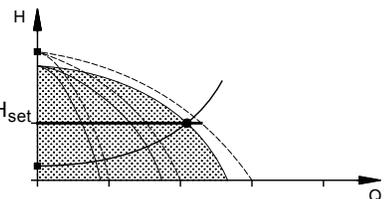
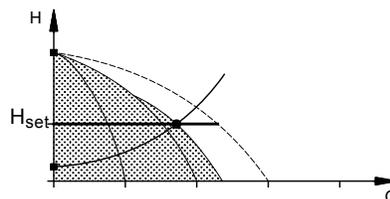
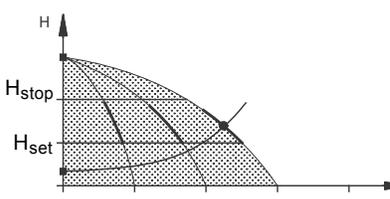
Systems with speed-controlled pumps	Systems with pumps connected to one CUE frequency converter	Systems with mains-operated pumps
Hydro MPC-E	Hydro MPC-F	Hydro MPC-S
<p>Hydro MPC pump system with three CR(I)E pumps.</p> 	<p>System with three CR pumps connected to one Grundfos CUE frequency converter in the control cabinet. The speed-controlled operation alternates between the pumps.</p> 	<p>System with three mains-operated CR(I) pumps.</p> 
<p>One CRE pump in operation.</p> 	<p>One CR pump connected to one Grundfos CUE frequency converter in operation.</p> 	<p>One mains-operated CR pump in operation.</p> 
<p>Three CRE pumps in operation.</p> 	<p>One CR pump connected to one Grundfos CUE frequency converter and two mains-operated CR pumps in operation.</p> 	<p>Three mains-operated CR pumps in operation.</p> 
<ul style="list-style-type: none"> Hydro MPC-E maintains a constant pressure through continuous adjustment of the speed of the pumps. The system performance is adjusted to the demand through cutting in/out the required number of pumps and through parallel control of the pumps in operation. Pump changeover is automatic and depends on load, operating hours and fault. All pumps in operation will run at equal speed. 	<ul style="list-style-type: none"> Hydro MPC-F maintains a constant pressure through continuous adjustment of the speed of the CR pump connected to the Grundfos CUE frequency converter. The speed-controlled operation alternates between the pumps. One CR pump connected to the Grundfos CUE frequency converter always starts first. If the pressure cannot be maintained by the pump, one or two mains-operated CR pumps will be cut in. Pump changeover is automatic and depends on load, operating hours and fault. 	<ul style="list-style-type: none"> Hydro MPC-S maintains an almost constant pressure through cutting in/ out the required number of pumps. The operating range of the pumps will lie between H_{set} and H_{stop} (cut-out pressure). Pump changeover is automatic and depends on load, operating hours and fault.

8. Operating panel

The operating panel in the front cover of the control cabinet features a display, a number of buttons and two indicator lights. The operating panel enables manual setting and monitoring of the performance of the system.

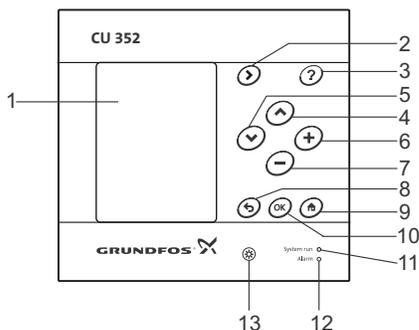

Fig. 12 Operating panel

Pos.	Description
1	Display
2	Arrow to the right
3	Help
4	Up
5	Down
6	Plus
7	Minus
8	Back
9	Home
10	OK
11	Indicator light, operation (green)
12	Indicator light, fault (red)
13	Brightness

TM05 3043 0812

8.1 Display

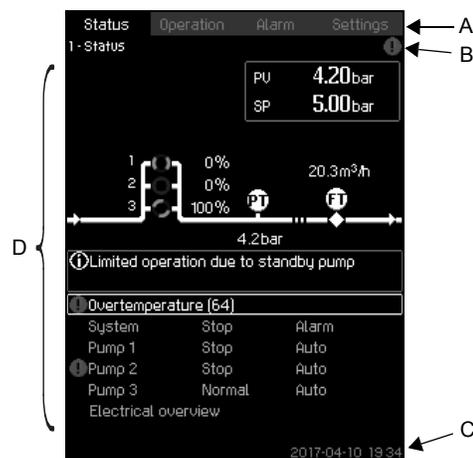

Fig. 13 Display design

TM03 8947 0517

8.1.1 Menu line

The menu line (A) is illustrated in fig. 13.

The display has four main menus:

Status	Indication of system status
Operation	Change of operating parameters such as setpoint
Alarm	Alarm log for fault finding
Settings	Change of settings (password option)

8.1.2 Top line

The top line (B) is illustrated in fig. 13. It shows the following:

- the display number and title (left side)
- the selected menu (left side)
- the symbol ⊗ in case of alarm (right side)
- the symbol △ in case of warning (right side)
- the symbol ↗ if the service language has been selected (right side).

8.1.3 Graphical illustration

The graphical illustration (D) may show a status, an indication or other elements, depending on the position in the menu structure. The illustration may show the entire system or part of it as well as various settings.

8.1.4 Scroll bar

If the list of illustration elements exceeds the display, the symbols ▲ and ▼ appear in the scroll bar to the right. Move up and down in lists with these symbols.

8.1.5 Bottom line

The bottom line (C) shows the date and time.

8.2 Buttons and indicator lights

The buttons (2 to 10 in fig. 12) on CU 352 are active when they are on.

8.2.1 Arrow to the right (2)

Press [>] to go to the next menu in the menu structure. If you press [>] when the menu "Settings" is highlighted, you will go to the menu "Status".

8.2.2 Help (3)

When this symbol is on, a help text applying to the display will appear if you press the button.

Close the text with ↵.

8.2.3 Up and down (4 and 5)

Move up and down in lists with [v] and [^].

You can select a text with [OK] when it is in a box.

If a text is marked and you press [^], the text above will be marked. If you press [v], the text below will be marked.

If you press [v] in the last line in the list, the first line will be marked.

If you press [^] in the first line in the list, the last line will be marked.

8.2.4 Plus and minus (6 and 7)

Increase and reduce a value with [+] and [-]. Save with [OK].

8.2.5 Back (8)

Press ↵ to go one display back in the menu.

If you have changed a value and press ↵, the new value will not be saved. See also section [8.2.7 OK \(10\)](#).

If you press [OK] before pressing ↵, the new value will be saved. See also section [8.2.7 OK \(10\)](#).

8.2.6 Home (9)

Press 🏠 to return to the menu "Status".

8.2.7 OK (10)

Use the button as an enter button.

The button is also used to start the setting of a value. If you have changed a value, press [OK] to save the change.

8.2.8 Indicator lights (11 and 12)

The operating panel incorporates a green and red indicator light.

The green indicator light will be on when the system is in operation and flash when the system has been set to stop.

The red indicator light will be on if there is an alarm or a warning. The fault can be identified from the alarm list.

8.2.9 Brightness (13)

You can change the brightness in the display with this button:

1. Press ☉.
2. Adjust the brightness with [+] and [-].

8.2.10 Back light

If no button is touched for 15 minutes, the back light of the display will be dimmed, and the first display in the menu "Status" will appear.

Press any button to re-activate the back light.

9. Functions

9.1 Tree of functions

The functions depend on the configuration of the system.

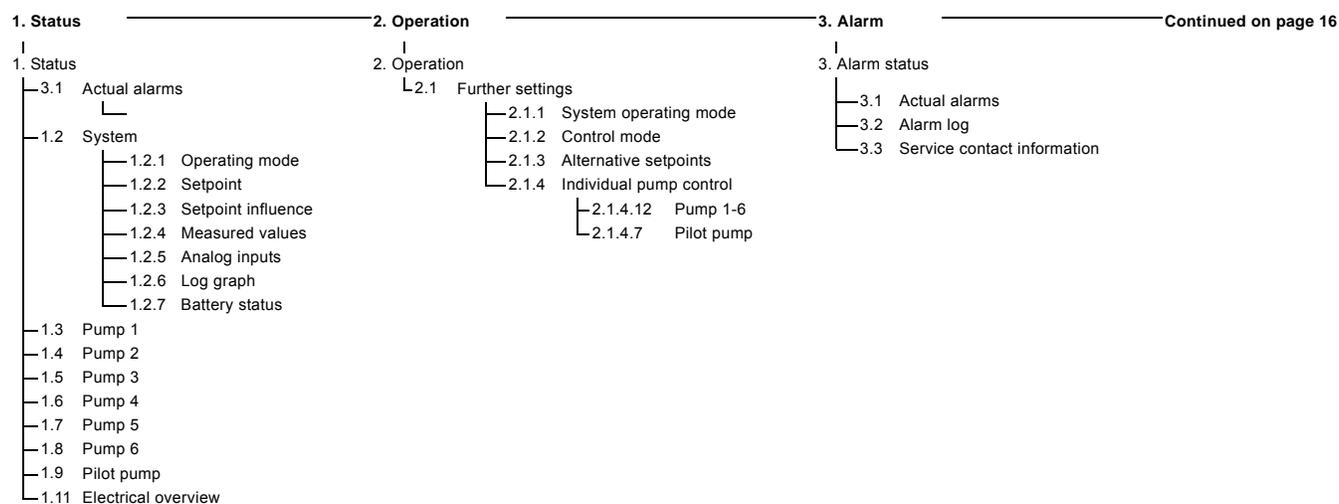

Continued on page 16

Key to the four menus

Status

This menu shows alarms, status of the system and a graph of logged data.

Note: No settings can be made in this menu.

Operation

In this menu, you can set the basic parameters, such as setpoint, operating mode, control mode and individual pump control.

Alarm

This menu gives an overview of alarms and warnings. You can reset alarms and warnings in this menu.

Settings

In this menu, you can set various functions:

- Primary controller
PI controller, Alternative setpoints, External setpoint influence, Primary sensor, Secondary sensor, Clock program, Proportional pressure, S-system configuration, Setpoint ramp.
- Pump cascade control
Min. time between start/stop, Max. number of starts/hour, Number of standby pumps, Forced pump changeover, Pump test run, Pump stop attempt, Pump start and stop speed, Min. performance, Compensation for pump start-up time.
- Secondary functions
Stop function, Soft pressure build-up, Digital inputs, Analog inputs, Digital outputs*, Analog outputs, Counter inputs, Emergency run, Min., max. and user-defined duty, Pump curve data, Control source, Fixed inlet pressure, Flow estimation, Reduced operation, Multisensor settings.
- Monitoring functions
Dry-running protection, Min. pressure, Max. pressure, External fault, Limit 1 exceeded, Limit 2 exceeded, Pumps outside duty range, Pressure relief, Log values, Fault, primary sensor, Non-return valve.
- Functions, CU 352
Display language, Units, Date and time, Password, Ethernet, GENibus number Software status, Display 1, Display 2, Display 3.

* If an IO 351 is installed.

1->	4. Settings			
	4.1	Primary controller		
	4.1.1	PI controller		
	4.1.2	Alternative setpoints		
	4.1.2.1	Alternative setpoints 2-7		
	4.1.3	External setpoint influence		
	4.1.3.1	Input value to be influenced by		
	4.1.3.2	Setting of influence function		
	4.1.4	Primary sensor		
	4.1.5	Secondary sensor		
	4.1.6	Clock program		
	4.1.7	Proportional pressure		
	4.1.8	S-system configuration		
	4.1.9	Setpoint ramp		
	4.2	Pump cascade control		
	4.2.1	Min. time between start/stop		
	4.2.2	Max. number of starts/hour		
	4.2.3	Standby pumps		
	4.2.4	Forced pump changeover		
	4.2.5	Pump test run		
	4.2.7	Pump stop attempt		
	4.2.8	Pump start and stop speed		
	4.2.9	Min. performance		
	4.2.10	Compensation for pump start-up time		
	4.3	Secondary functions		
	4.3.1	Stop function		
	4.3.1.1	Stop parameters		
	4.3.3	Soft pressure build-up		
	4.3.5	Emergency run		
	4.3.7	Digital inputs		
		Function, DI1 (CU 352) - DI3, [10, 12, 14]		
		Function, DI1 (IO 351-41) - DI9, [10-46]		
		Function, DI1 (IO 351-42) - DI9, [10-46]		
	4.3.8	Analog inputs		
		Setting, AI1 (CU 352), [51] - AI3, [51, 54, 57]		
		Function, AI1 (CU 352) - AI3 [51, 54, 57]		
		Setting, AI1 (IO 351-41), [57] - AI2 [57, 60]		
		Function, AI1 (IO 351-41) - AI2 [57, 60]		
		Setting, AI1 (IO 351-42), [57] - AI2 [57, 60]		
		Function, AI1 (IO 351-42) - A2 [57, 60]		
	4.3.9	Digital outputs		
		DO1 (CU 352), [71] is signalling - DO2 [71, 74]		
		DO1 (IO 351-41), [77] is signalling - DO7 [77-88]		
		DO1 (IO 351-42), [77] is signalling - DO7 [77-88]		
	4.3.10	Analog outputs		
		AO1 (IO 351-41) [18] - AO3 [18, 22, 26]		
		AO1 (IO 351-42) [18] - AO3 [18, 22, 26]		
	4.3.11	Counter inputs		
	4.3.14	Min., max. and user-defined duty		
	4.3.14.1	Min. duty		
	4.3.14.2	Max. duty		
	4.3.14.3	Set user-defined duty		
	4.3.19	Pump curve data		
	4.3.23	Flow estimation		
	4.3.20	Control source		
	4.3.22	Fixed inlet pressure		
	4.3.23	Flow estimation		
	4.3.24	Reduced operation		
	4.3.25	Multisensor settings		
	4.4	Monitoring functions		
	4.4.1	Dry-running protection		
	4.4.1.1	Pressure/level switch		
	4.4.1.2	Measurement, inlet pressure		
	4.4.1.3	Measurement, tank level		
	4.4.2	Min. pressure		
	4.4.3	Max. pressure		
	4.4.4	External fault		
	4.4.5	Limit 1 exceeded		
	4.4.6	Limit 2 exceeded		
	4.4.7	Pumps outside duty range		
	4.4.8	Pressure relief		
	4.4.9	Log values		
	4.4.10	Fault, primary sensor		
	4.4.11	Non-return valve		
	4.5	Functions, CU 352		
		Change language to the service language (English)		
		Run wizard again		
	4.5.1	Display language		
	4.5.2	Units		
	4.5.2.1	Pressure		
	4.5.2.2	Differential pressure		
	4.5.2.3	Head		
	4.5.2.4	Level		
	4.5.2.5	Flow rate		
	4.5.2.6	Volume		
	4.5.2.7	Specific		
	4.5.2.8	Temperature		
	4.5.2.9	Power		
	4.5.2.10	Energy		
	4.5.3	Date and time		
	4.5.4	Password		
	4.5.5	Ethernet		
	4.5.6	GENbus number		
	4.5.9	Software status		

9.2 Overview

Section	Display and display number	Page
9.4 Status (1)		19
9.4.1	Actual alarms (3.1)	20
9.4.2	System (1.2)	20
9.4.3	Operating mode (1.2.1)	20
9.4.4	Setpoint (1.2.2)	21
9.4.5	Setpoint influence (1.2.3)	21
9.4.6	Measured values (1.2.4)	21
9.4.7	Analog inputs (1.2.5)	22
9.4.8	Log graph (1.2.6)	22
9.4.9	Battery status (1.2.7)	22
9.4.10	Pump 1-6, Pilot pump (1.3 - 1.10)	23
9.5 Operation (2)		23
9.5.1	Operation (2)	23
9.5.2	System operating mode (2.1.1)	24
9.5.3	Control mode (2.1.2)	24
9.5.4	Alternative setpoints (2.1.3)	26
9.5.5	Individual pump control (2.1.4)	27
9.5.6	Pump 1-6 (2.1.4.1 - 2.1.4.6)	27
9.5.7	Operation, pilot pump (2.1.4.7)	28
9.6 Alarm (3)		28
9.6.1	Alarm status (3)	28
9.6.2	Actual alarms (3.1)	30
9.6.3	Alarm log (3.2)	30
9.6.4	Service contact information (3.3)	30
9.7 Settings (4)		31
9.7.1	Primary controller (4.1)	31
9.7.2	PI controller (4.1.1)	32
9.7.3	Alternative setpoints (4.1.2)	33
9.7.4	Alternative setpoints 2-7 (4.1.2.1 - 4.1.2.7)	33
9.7.5	External setpoint influence (4.1.3)	34
9.7.6	Setting of influence function (4.1.3.2)	35
9.7.7	Primary sensor (4.1.4)	35
9.7.9	Clock program (4.1.6)	36
9.7.10	Proportional pressure (4.1.7)	37
9.7.11	S-system configuration (4.1.8)	38
9.7.12	Setpoint ramp (4.1.9)	38
9.7.13	Pump cascade control (4.2)	39
9.7.14	Min. time between start/stop (4.2.1)	39
9.7.15	Max. number of starts/hour (4.2.1)	39
9.7.16	Standby pumps (4.2.3)	40
9.7.17	Forced pump changeover (4.2.4)	40
9.7.18	Pump test run (4.2.5)	41
9.7.19	Pump stop attempt (4.2.7)	41
9.7.20	Pump start and stop speed (4.2.8)	42
9.7.21	Min. performance (4.2.9)	42
9.7.22	Compensation for pump start-up time (4.2.10)	43
9.7.23	Secondary functions (4.3)	43
9.7.24	Stop function (4.3.1)	43
9.7.25	Soft pressure build-up (4.3.3)	46
9.7.26	Emergency run (4.3.5)	47

Section	Display and display number	Page
9.7.27	<i>Digital inputs (4.3.7)</i>	47
9.7.28	<i>Functions of digital inputs (4.3.7.1)</i>	48
9.7.29	<i>Analog inputs (4.3.8)</i>	48
9.7.30	<i>Analog inputs (4.3.8.1 to 4.3.8.7)</i>	49
9.7.31	<i>Analog inputs and measured value (4.3.8.1.1 - 4.3.8.7.1)</i>	49
9.7.32	<i>Digital outputs (4.3.9)</i>	50
9.7.33	<i>Function of digital outputs (4.3.9.1 - 4.3.9.16)</i>	50
9.7.34	<i>Analog outputs (4.3.10)</i>	51
9.7.35	<i>Output signal (4.3.10.1 - 4.3.10.3)</i>	51
9.7.37	<i>Min., max. and user-defined duty (4.3.14)</i>	52
9.7.38	<i>Min. duty (4.3.14.1)</i>	53
9.7.39	<i>Max. duty (4.3.14.2)</i>	53
9.7.40	<i>User-defined duty (4.3.14.3)</i>	54
9.7.41	<i>Pump curve data (4.3.19)</i>	54
9.7.42	<i>Control source (4.3.20)</i>	56
9.7.43	<i>Fixed inlet pressure (4.3.22)</i>	56
9.7.44	<i>Flow estimation (4.3.23)</i>	57
9.7.45	<i>Reduced operation (4.3.24)</i>	57
9.7.48	<i>Monitoring functions (4.4)</i>	59
9.7.49	<i>Dry-running protection (4.4.1)</i>	59
9.7.50	<i>Pressure/level switch (4.4.1.1)</i>	60
9.7.51	<i>Measurement, inlet pressure (4.4.1.2)</i>	60
9.7.52	<i>Measurement, tank level (4.4.1.3)</i>	61
9.7.53	<i>Min. pressure (4.4.2)</i>	61
9.7.54	<i>Max. pressure (4.4.3)</i>	62
9.7.55	<i>External fault (4.4.4)</i>	62
9.7.56	<i>Limit 1 exceeded (4.4.5 - 4.4.6)</i>	63
9.7.57	<i>Pumps outside duty range (4.4.7)</i>	64
9.7.58	<i>Pressure relief (4.4.8)</i>	64
9.7.59	<i>Log values (4.4.9)</i>	65
9.7.60	<i>Fault, primary sensor (4.4.10)</i>	65
9.7.62	<i>Functions, CU 352 (4.5)</i>	66
9.7.63	<i>Display language (4.5.1)</i>	67
9.7.64	<i>Units (4.5.2)</i>	67
9.7.65	<i>Date and time (4.5.3)</i>	68
9.7.66	<i>Password (4.5.4)</i>	69
9.7.67	<i>Ethernet (4.5.5)</i>	69
9.7.68	<i>GENIbus number (4.5.6)</i>	69
9.7.69	<i>Software status (4.5.9)</i>	70
9.7.70	<i>Status display menu (4.6)</i>	70

9.3 Description of functions

The description of functions is based on the four main menus of the CU 352 control unit:

- Status
- Operation
- Alarm
- Settings.

The functions apply to all control variants unless otherwise stated.

9.4 Status (1)

The first status display is shown below. This display is shown when the power is switched on, and it appears if the buttons of the operating panel remain untouched for 15 minutes.

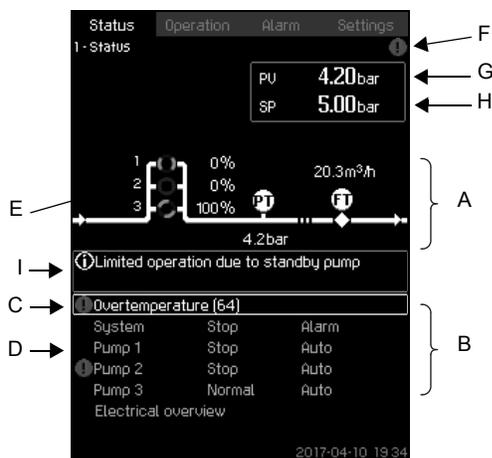

Fig. 14 Status

Description

No settings can be made in this menu.

The actual value (process value, PV) of the control parameter, usually the outlet pressure, is shown in the upper right corner (G) together with the selected setpoint (SP) (H).

The upper half of the display (A) shows a graphic illustration of the pump system. The selected measuring parameters are shown with sensor symbol and actual value.

In MPC-E systems where the differential pressure across the pumps and pump curve data are known, the display shows the estimated flow rate when the flow rate and speed of the pumps are within a range where it is possible to estimate the flow rate.

≈ : This indicates that the flow rate is an estimated value.



The estimated flow rate may differ from a measured value.

In the middle of the display, an information field (I) is shown if any of the following events occurs:

- Limited operation due to standby pump
- Proportional-pressure influence active
- External setpoint influence active
- Alternative setpoint active
- Low flow boost active
- Pressure relief active
- Clock program active
- Remote-controlled via GENI (RS-485)
- Limited due to reduced operation
- Stopped due to low flow.

The lower display half (B) shows the following:

- the most recent active alarm, if any, and the fault cause with the fault code in brackets
- system status with actual operating mode and control source
- pump status with actual operating mode.



If a fault has occurred, the warning symbol \triangle or alarm symbol \otimes is shown in the line (C) together with the cause and fault code, for instance "Overtemperature (64)".

If the fault is related to one of the pumps, one of the symbols \triangle or \otimes is also shown in front of the status line (D) of the pump in question. At the same time, the pump status indicator (E) changes color to either yellow or red as described in the table below. The symbol \triangle or \otimes is shown to the right in the top line of the display (F). As long as a fault is present, this symbol is shown in the top line of all displays.

To open a menu line, select the line with [V] or [^] and press [OK].

The display allows you to open status displays showing the following:

- actual alarms
- system status
- status of each pump.

Description of pump status

Pump status indicator	Description
Rotating, green	The pump is running.
Permanently green	The pump is ready (not running).
Rotating, yellow	Warning. The pump is running.
Permanently yellow	Warning. The pump is ready (not running).
Permanently red	Alarm. The pump is stopped.

TM03 8947 0517

9.4.1 Actual alarms (3.1)

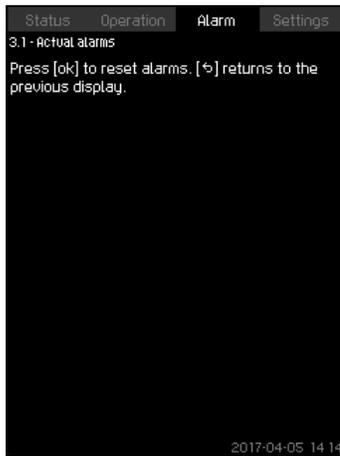

Fig. 15 Actual alarms

Description

This display shows active unset alarms and warnings. For further information, see sections [9.6.2 Actual alarms \(3.1\)](#) and [9.6.3 Alarm log \(3.2\)](#).

9.4.2 System (1.2)

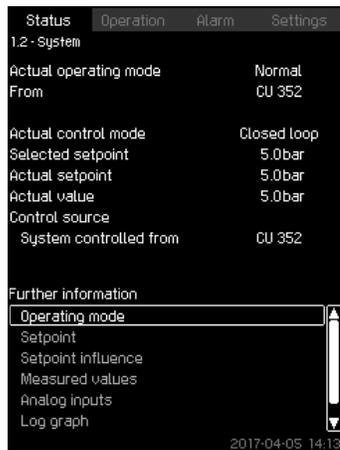

Fig. 16 System

Description

This display shows the operational state of the system. Go to subdisplays for further details.

The display allows you to open displays about the following:

- Operating mode
- Setpoint
- Setpoint influence
- Measured values
- Analog inputs
- Log graph
- Battery status.

9.4.3 Operating mode (1.2.1)

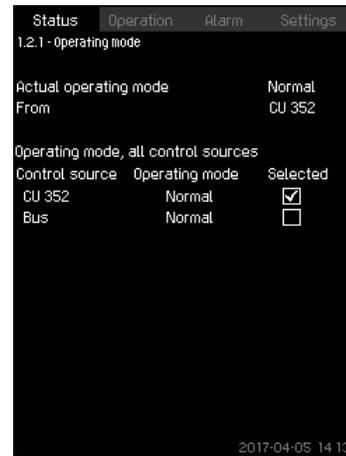

Fig. 17 Operating mode

Description

This display shows the operating mode of the system and from where it is controlled.

Operating modes

The system has six operating modes:

1. Normal
 - The pumps adapt their performance to the requirement.
2. Max.
 - The pumps run at a constant high speed. Normally, all pumps run at maximum speed.
3. User-defined
 - The pumps run at a constant speed set by the user. It is usually a performance between "Max." and "Min.".
4. Min.
 - The pumps run at a constant low speed. Normally, one pump is running at a speed of 70 %.
5. Stop
 - All pumps have been stopped.
6. Emergency run
 - The pumps run according to the setting made in display [Emergency run \(4.3.5\)](#).

The performance required in these operating modes can be set in the menu "Settings":

- Max.
- Min.
- User-defined
- Emergency run.

See sections [9.7.37 Min., max. and user-defined duty \(4.3.14\)](#) and [9.7.26 Emergency run \(4.3.5\)](#).

The actual operating mode can be controlled from four different sources:

- Fault
- External signal
- CU 352
- Bus.

Control source

You can set the system to remote control via an external bus (option). In this case, you must set a setpoint and an operating mode via the bus.

In the menu "Settings", you can select whether CU 352 or the external bus is to be the control source.

The status of this setting is shown in the display "Operating mode".

9.4.4 Setpoint (1.2.2)



Fig. 18 Setpoint

Description

This display shows the selected setpoint and whether it comes from CU 352 or an external bus.

The display also shows all seven possible setpoints from CU 352 (for closed- and open-loop control). At the same time, the selected setpoint is shown.

As it is a status display, no settings can be made.

You can change the setpoints in the menus "Operation" or "Settings". See section [9.7.3 Alternative setpoints \(4.1.2\)](#).

9.4.5 Setpoint influence (1.2.3)

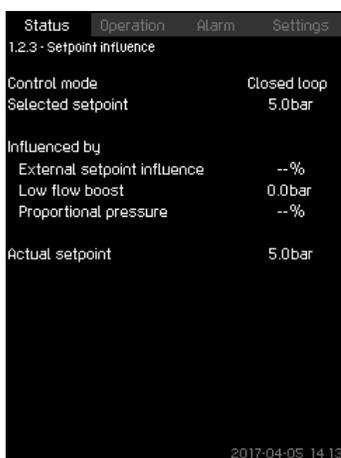

Fig. 19 Setpoint influence

Description

The selected setpoint can be influenced by parameters. The parameters are shown as percentage from 0 to 100 % or as a pressure measured in psi. They can only reduce the setpoint, as the influence in percentage divided with 100 is multiplied with the selected setpoint:

Actual setpoint (SP) = selected setpoint x influence (1) x influence (2) x etc.

The display shows the parameters influencing the selected setpoint and the percentage or value of influence.

You can set some of the possible parameters in the display [External setpoint influence \(4.1.3\)](#). The parameter "Low flow boost" is set as a start/stop band as a percentage of the setpoint set in the display [Stop function \(4.3.1\)](#). The parameter is set as a percentage in the display [Proportional pressure \(4.1.7\)](#).

Finally, the resulting actual setpoint (SP) is shown.

9.4.6 Measured values (1.2.4)

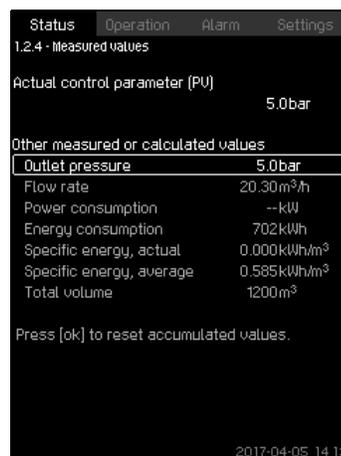

Fig. 20 Measured values

Description

This display gives a general status of all measured and calculated parameters. In MPC-E systems with a flowmeter, the specific energy is shown as an average value and actual value (mean value over the last minute). The average value is based on the accumulated flow shown as total volume. The total volume and specific energy average can be reset in this display.



The lines "Power consumption" and "Energy consumption" are only shown in MPC-E systems.

9.4.7 Analog inputs (1.2.5)

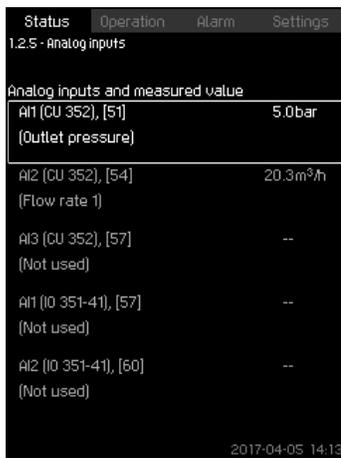

Fig. 21 Analog inputs

Description

This display shows an overview of the analog inputs and the measured values of each input. See sections [9.7.29 Analog inputs \(4.3.8\)](#), [9.7.30 Analog inputs \(4.3.8.1 to 4.3.8.7\)](#) and [9.7.31 Analog inputs and measured value \(4.3.8.1.1 - 4.3.8.7.1\)](#).

9.4.8 Log graph (1.2.6)

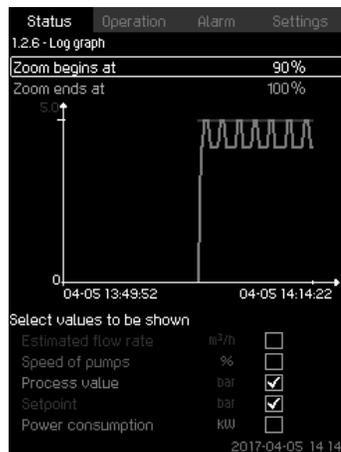

Fig. 22 Log graph

Description

In this display, you can see logged data stored in the controller. Select log values in the display [Log values \(4.4.9\)](#). Various values can be shown, and the time scale can be changed.

Setting via the operating panel

Status > System > Log graph

- Set as a percentage:
 - Zoom begins at
 - Zoom ends at
- Select values to be shown.

9.4.9 Battery status (1.2.7)



Fig. 23 Battery status

Description

Here you can see the status of the backup battery, if installed.

9.4.10 Pump 1-6, Pilot pump (1.3 - 1.10)

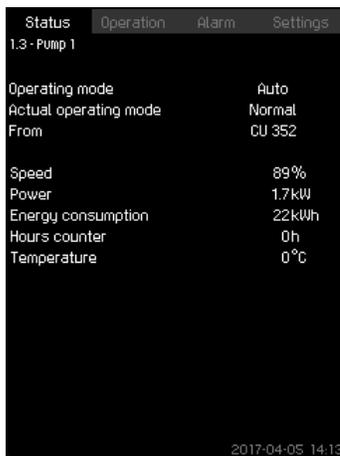

Fig. 24 Pump 1

Description

This display shows the operational state of the individual pumps.



The displays for the pilot pump are only shown if such pumps are installed.

The pumps can have different operating modes:

- Auto
Together with the other pumps in automatic operation, the pump is controlled by the PI controller which ensures that the system delivers the required performance.
- Manual
The pump is not controlled by the PI controller. In manual operation, the pump has one of the following operating modes:
 - Max.
The pump runs at a set maximum speed. (This operating mode can only be selected for variable-speed pumps.)
 - Normal
The pump runs at a set speed.
 - Min.
The pump runs at a set minimum speed. (This operating mode can only be selected for variable-speed pumps.)
 - Stop
The pump has been forced to stop.

Besides information about the operating mode, you can read various parameters in the status display, such as these:

- Actual operating mode
- Control source
- Speed (only 0 or 100 % are shown for mains-operated pumps)
- Power (only MPC-E/-EC)
- Energy consumption (only MPC-E/-EC)
- Operating hours
- Temperature.

9.5 Operation (2)

In this menu, you can set the basic parameters, such as setpoint, operating mode, control mode and individual pump control.

9.5.1 Operation (2)

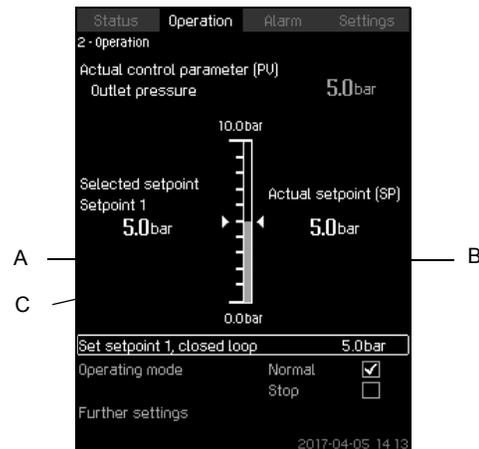

Fig. 25 Operation

Description

The column shows the setting range. In closed-loop control, it corresponds to the range of the primary sensor, here 0-145 psi (0-10 bar). In open-loop control, the setting range is 0-100 %.

At the left hand of the column, you can see the selected setpoint 1 (A), that is the value set in the display. At the right hand of the column, you can see the actual setpoint (B), that is the setpoint acting as reference for the PI controller. If no kind of external setpoint influence has been selected, the two values will be identical. The measured value (outlet pressure) is shown as the grey part of the column (C). See sections [9.7.5 External setpoint influence \(4.1.3\)](#) and [9.7.6 Setting of influence function \(4.1.3.2\)](#).

Below the display is a menu line for setting of setpoint 1 and selection of operating mode, including the operating modes "Normal" and "Stop". You can select further settings: "System operating mode", "Control mode", "Alternative setpoints" and "Individual pump control".

Setting range

Setpoint:

Closed-loop control: Measuring range of the primary sensor

Open-loop control: 0-100 %.

Setting via the operating panel

Setpoint

- Operation > Set setpoint 1, open loop / Set setpoint 1, closed loop.

Set the value.

Operating mode

- Operation

Select: Normal or Stop.

Further settings

- Operation > Further settings.

Select one of the settings below:

- System operating mode (see section [9.5.2](#)).
- Control mode (see section [9.5.3](#)).
- Alternative setpoints (see section [9.5.4](#)).
- Individual pump control (see section [9.5.6](#)).

Factory setting

The setpoint is a value suitable for the system in question. The factory setting may have been changed in the startup menu.

9.5.2 System operating mode (2.1.1)

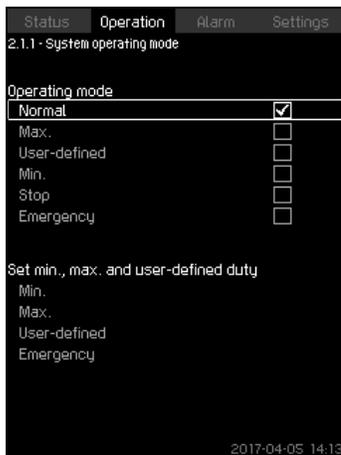

Fig. 26 System operating mode

Description

The system can be set to six different operating modes. "Normal" is the typical setting. See section [9.4.3 Operating mode \(1.2.1\)](#). You can set the performance of the operating modes in this menu:

- Min.
- Max.
- User-defined
- Emergency.

Setting range

- Normal
- Max.
- Min.
- User-defined
- Stop
- Emergency.

Setting via the operating panel

- Operation > Further settings > System operating mode > Operating mode.

Select the desired line at the bottom of the display to set the performance for "Max.", "Min.", "User-defined" and "Emergency" run. See sections [9.7.37 Min., max. and user-defined duty \(4.3.14\)](#) and [9.7.26 Emergency run \(4.3.5\)](#).

Factory setting

Normal.

9.5.3 Control mode (2.1.2)

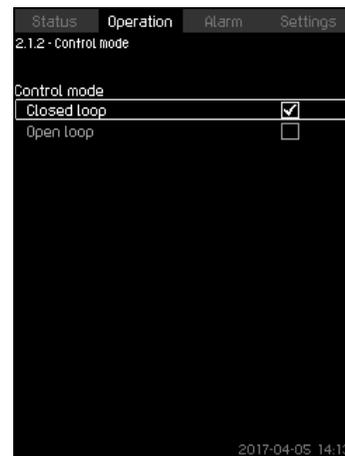

Fig. 27 Control mode

Description

There are two control modes, namely closed and open loop.

Closed loop

The typical control mode is "Closed loop" where the built-in PI controller ensures that the system reaches and maintains the selected setpoint. The performance is based on the setpoint set for closed loop. See [figs 28 and 29](#).

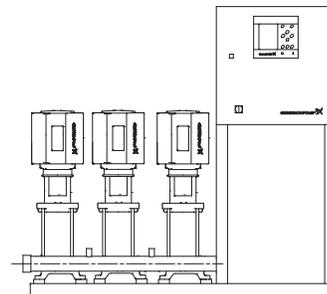

Fig. 28 Pump system controlled by built-in PI controller (closed loop)

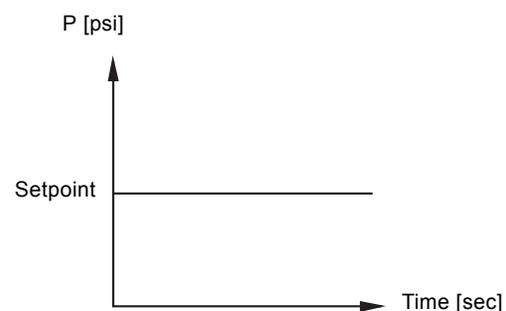

Fig. 29 Regulation curve for closed loop

TM03 2231 3905

TM03 2390 4105

Setting via the operating panel

- Operation > Further settings > Control mode > Closed loop.
- Set the setpoint. See sections [9.5.4 Alternative setpoints \(2.1.3\)](#) and [9.5.1 Operation \(2\)](#).

Open loop

In open-loop control mode, the pumps run at a fixed speed. The pump speed is calculated from the performance set by the user (0-100 %). The pump performance in percentage is proportional with the flow rate.

Open-loop control mode is usually used when the system is controlled by an external controller which controls the performance via an external signal. The external controller could for instance be a building management system connected to the MPC system. In such cases MPC is like an actuator. See figs [30](#) and [31](#).

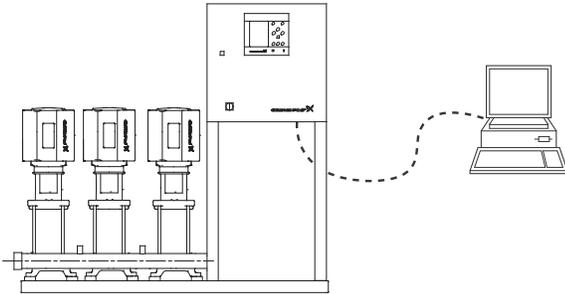

Fig. 30 Pump system with external controller (open loop)

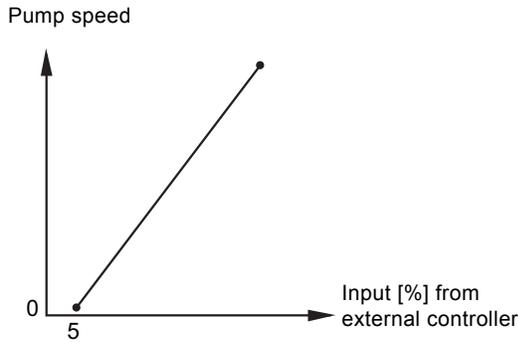

Fig. 31 Regulation curve for open loop

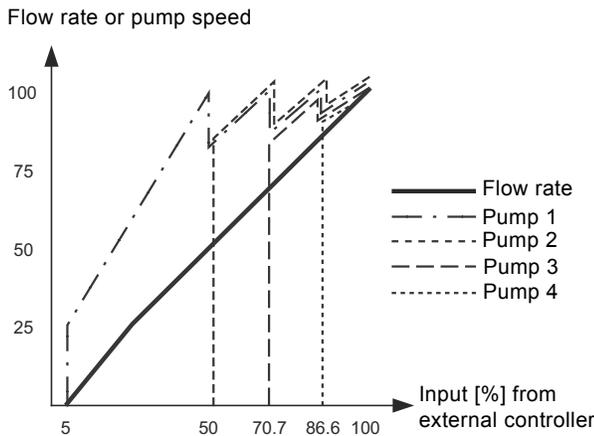

Fig. 32 Regulation curve for MPC-E system in open loop

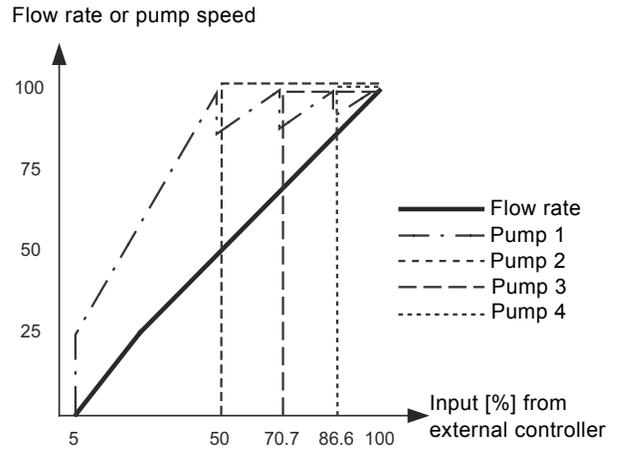

Fig. 33 Regulation curve for MPC-F system in open loop

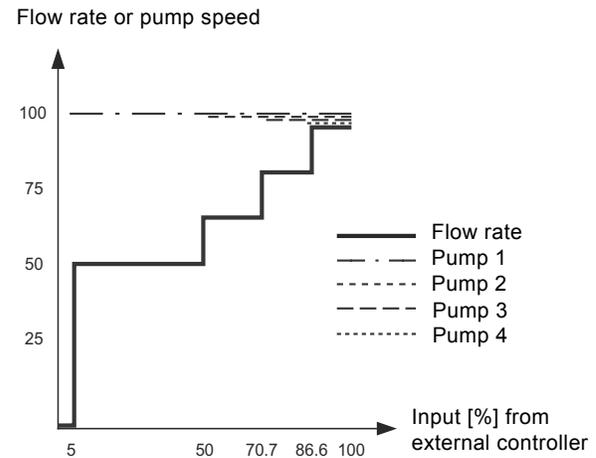

Fig. 34 Regulation curve for MPC-S system in open loop

Setting range

These settings must be made in connection with open loop:

- Open loop
- Set setpoint 1, open loop
- External setpoint influence
- Normal.

TM03 9975 4807

TM03 2232 3905

TM03 2391 3607

TM03 9977 4807

TM03 9974 4807

Setting via the operating panel

Proceed as follows to set an external control source to control the system:

- Operation > Further settings > Control mode.
 - Select: Open loop.
1. Press **↵** x 2.
 2. Select: Stop
 3. Set to 100 %: Set setpoint 1, open loop.
 4. Settings > Primary controller > External setpoint influence > Go to setting of analog input.
 5. Select analog input and range.
 6. Select:
 - Measured input value. Display 4.3.8.1.1 appears.
 - Select: 0-100 % signal.
 7. Press **↵**.
 8. Set the minimum and maximum sensor value.
 9. Press **↵** x 2.
 10. Select:
 - Input value to be influenced by
 - 0-100 % signal.
 11. Press **↵**.
 12. Select: Set the influence function. See also section [9.7.6 Setting of influence function \(4.1.3.2\)](#).
 13. Set the number of points.
 14. Set for Point 1:
 - External input value
 - Reduce setpoint to
 15. Repeat step 14 for all selected points.
 16. Press **↵**.
 17. Set as seconds: Filter time.
 18. Select: Enabled.
 19. Press **↵** x 2.
 20. Select:
 - Operation
 - Normal.

The pump system can now be controlled by an external controller.

Factory setting

Closed loop.

9.5.4 Alternative setpoints (2.1.3)

Status	Operation	Alarm	Settings
2.1.3 - Alternative setpoints			
Set the setpoints.			
Closed loop			
Setpoint 1			5.0bar
Setpoint 2			3.3bar
Setpoint 3			3.5bar
Setpoint 4			3.8bar
Setpoint 5			4.0bar
Setpoint 6			4.3bar
Setpoint 7			4.5bar
Open loop			
Setpoint 1			10%
Setpoint 2			20%
Setpoint 3			30%
Setpoint 4			40%
Setpoint 5			50%
Setpoint 6			60%
Setpoint 7			70%
2017-04-05 14:13			

Fig. 35 Alternative setpoints

Description

In addition to the primary setpoint 1 (shown in display 2 in menu "Operation"), you can set six alternative setpoints for closed-loop control mode. Furthermore, you can set seven setpoints for open-loop control mode.

You can activate one of the alternative setpoints by means of external contacts. See sections [9.7.3 Alternative setpoints \(4.1.2\)](#) and [9.7.4 Alternative setpoints 2-7 \(4.1.2.1 - 4.1.2.7\)](#).

Setting range

The setting range of setpoints for closed-loop control mode depends on the range of the primary sensor. See section [9.7.7 Primary sensor \(4.1.4\)](#).

In open-loop control mode, the setting range is 0-100 %.

Setting via the operating panel

- Operation > Further settings > Alternative setpoints.
- Set the setpoint.

Factory setting

Setpoint 1 for closed-loop control mode is a value suitable for the system in question.

The alternative setpoints for closed-loop control mode are 44 psi (3 bar).

All setpoints for open-loop control mode are 70 %.

9.5.5 Individual pump control (2.1.4)

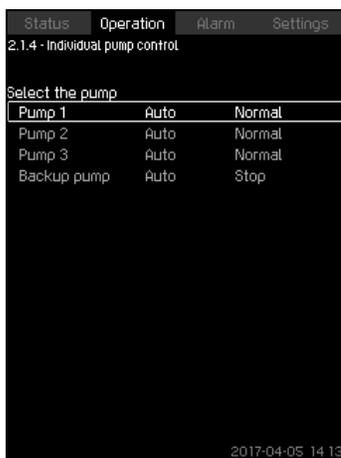

Fig. 36 Individual pump control

Description

You can change the operating mode from automatic operation to one of the manual operating modes.

Auto

The pumps are controlled by the PI controller, ensuring that the system delivers the required performance.

Manual

The pump is not controlled by the PI controller, but set to one of the following manual operating modes:

- Max.
 - The pump runs at a set maximum speed. (This operating mode can only be selected for variable-speed pumps.)
- Normal
 - The pump runs at a set speed.
- Min.
 - The pump runs at a set minimum speed. (This operating mode can only be selected for variable-speed pumps.)
- Stop
 - The pump has been forced to stop.

Pumps in manual operation are not part of the normal pump cascade and speed control. The manual pumps are a "disturbance" of the normal operation of the system.

If one or more pumps are in manual operation, the system may not be able to deliver the set performance.

There are two displays for the function. In the first display, select the pump to be set, and in the next display, select the operating mode.

Setting range

All pumps can be selected.

Setting via the operating panel

Operation > Further settings > Individual pump control.

9.5.6 Pump 1-6 (2.1.4.1 - 2.1.4.6)

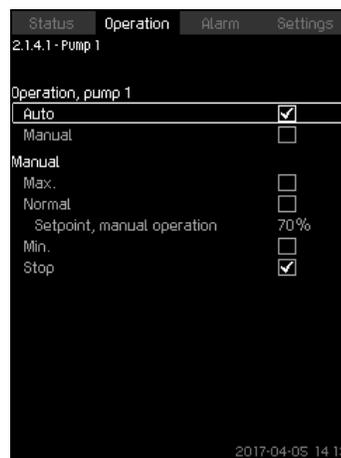

Fig. 37 Pump 1-6

Description

This display is shown for the individual pumps and it allows you to set an operating mode.

Setting range

You can select "Auto" or "Manual" as well as the operating mode of the pump for manual operation - "Max.", "Normal", "Min." or "Stop". For mains-operated pumps, you can only select "Normal" or "Stop".

Setting via the operating panel

- Operation > Further settings > Individual pump control.
 1. Select pump.
 2. Select resetting: Auto or Manual.
 3. Manual: Select operating mode.
Normal: Set the setpoint.

Factory setting

Auto.

9.5.7 Operation, pilot pump (2.1.4.7)

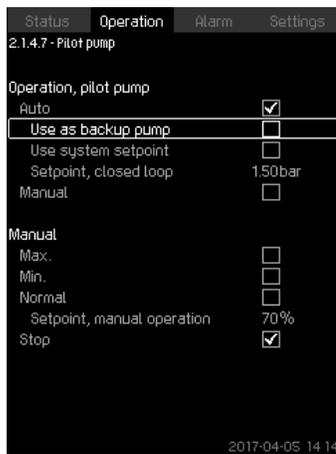

Fig. 38 Operation, pilot pump

Description

This display is only shown in systems that have been configured with a pilot pump.

You can set the operating mode and setpoint for the pilot pump.

Setting range

Auto

Select this mode if the pilot pump is to be used as a backup pump. If the pilot pump is selected as a backup pump, it will start if the main pumps are running at 100 % speed and still cannot reach or maintain the setpoint.

The setpoint of the pilot pump can either be set to the same value as that of the main pumps by selecting "Use system setpoint" or to another value.

Manual

Max., Normal, Min., Stop.

Setting via the operating panel

- Operation > Further settings > Individual pump control > Pilot pump.

Select resetting: Auto or Manual.

Auto

1. Select if the pump is also to be used as backup pump (only possible if the system does not already incorporate a backup pump).
2. Select "Use system setpoint" or enter a setpoint.

Manual

1. Select operating mode.
2. Normal: Set the setpoint.

Factory setting

Auto.

Use system setpoint.

9.6 Alarm (3)

This menu gives an overview of alarms and warnings.

You can reset alarms.

9.6.1 Alarm status (3)



Fig. 39 Alarm status

Description

A fault in the system or one of the components monitored can cause an alarm (⊗) or a warning (⚠). Besides the fault signal via the alarm and warning signal relay and the red indicator light on CU 352, an alarm can also cause a change of operating mode, for instance from "Normal" to "Stop". A warning only causes a fault indication.

The table shows the possible causes of fault together with an alarm code, and whether they result in an alarm or a warning. It also shows to what operating mode the system will change in case of alarm, and whether restarting of the system and resetting of the alarm is manual or automatic.

The table also shows that the reaction to some of the fault causes mentioned can be set in the menu "Settings". See sections [9.7.25 Soft pressure build-up \(4.3.3\)](#) and [9.7.48 Monitoring functions \(4.4\)](#) to [9.7.58 Pressure relief \(4.4.8\)](#).

Fault	Warning (⚠) Alarm (⊗)	Change of operating mode to	Resetting of alarm, restarting	Set in the menu "Settings"	Alarm code
Water shortage	⚠		Manual/automatic	X	206
Water shortage	⊗	Stop	Manual/automatic	X	214
Pressure high	⊗	Stop	Manual/automatic	X	210
Pressure low	⚠		Manual/automatic	X	211
	⊗	Stop	Manual/automatic		
Pressure relief	⚠		Manual/automatic	X	219
Alarm, all pumps	⊗	Stop	Automatic		203
External fault	⚠		Manual/automatic	X	3
	⊗	Stop	Manual/automatic		
Dissimilar sensor signals	⚠		Automatic		204
Fault, primary sensor	⊗	Stop	Automatic		89
Fault, sensor	⚠		Automatic		88
Communication fault	⚠		Automatic		10
Phase failure	⚠		Automatic		2
Undervoltage, pump	⚠		Automatic		7, 40, 42, 73
Overvoltage, pump	⚠		Automatic		32
Overload, pump	⚠		Automatic		48, 50, 51, 54
Motor temperature too high	⚠		Automatic		64, 65, 67, 70
Other fault, pump	⚠		Automatic		76, 83
Internal fault, CU 352	⚠		Automatic		83, 157
Internal fault, IO 351	⊗	Stop	Automatic		72, 83, 157
VFD not ready	⚠		Automatic		213
Fault, Ethernet	⚠		Automatic		231, 232
Limit 1 exceeded	⚠ ⊗		Manual/automatic	X	190
Limit 2 exceeded	⚠ ⊗		Manual/automatic	X	191
Pressure buildup fault	⚠ ⊗		Manual/automatic	X	215
Pumps outside duty range	⚠		Manual/automatic	X	208
Fault, pilot pump	⚠		Automatic		216
Multisensor fault	⊗		Automatic		143
Multisensor value exceeds limits	⚠		Automatic	X	87
Signal fault, secondary sensor	⚠		Automatic	X	93
Non-return valve fault	⚠		Manual/automatic	X	209
Non-return valve fault	⊗		Manual/automatic	X	209

9.6.2 Actual alarms (3.1)

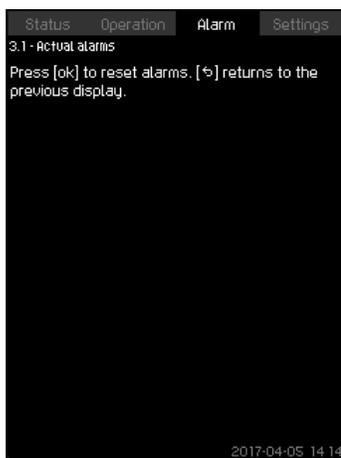

Fig. 40 Actual alarms

Description

This submenu shows the following:

- Warnings  caused by faults that still exist.
- Warnings  caused by faults that have disappeared, but the warning requires manual resetting.
- Alarms  caused by faults that still exist.
- Alarms  caused by faults that have disappeared, but the alarm requires manual resetting.

All warnings and alarms with automatic resetting are automatically removed from the menu when the fault has disappeared.

Alarms requiring manual resetting can be reset in this display by pressing [OK]. An alarm cannot be reset until the fault has disappeared.

For every warning or alarm, the following is shown:

- Whether it is a warning  or an alarm .
- Where the fault occurred: System, Pump 1, Pump 2, etc.
- In case of input-related faults, the input is shown.
- The cause of the fault and the alarm code in brackets, such as "Water shortage (214)".
- When the fault occurred: Date and time.
- When the fault disappeared: Date and time. If the fault still exists, date and time are shown as "--:--:--".

The most recent warning or alarm is shown at the top of the display.

9.6.3 Alarm log (3.2)

The alarm log can store up to 24 warnings and alarms.



Fig. 41 Alarm log

Description

This display shows warnings and alarms.

For every warning or alarm, the following is shown:

- Whether it is a warning  or an alarm .
- Where the fault occurred: System, Pump 1, Pump 2, etc.
- In case of input-related faults, the input is shown.
- The cause of the fault and the alarm code in brackets, such as "Water shortage (214)".
- When the fault occurred: Date and time.
- When the fault disappeared: Date and time. If the fault still exists, date and time are shown as "--:--:--".

The most recent warning or alarm is shown at the top of the display.

9.6.4 Service contact information (3.3)

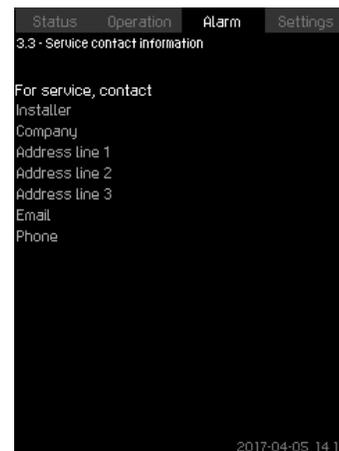

Fig. 42 Service contact information

Description

This display shows the contact information of the installer if entered during commissioning.

9.7 Settings (4)

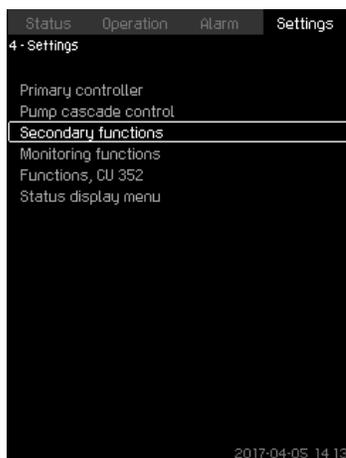

Fig. 43 Settings

In this menu, you can set the following functions:

- Primary controller
PI controller, Alternative setpoints, External setpoint influence, Primary sensor, Secondary sensor, Clock program, Proportional pressure, S-system configuration, Setpoint ramp.
- Pump cascade control
Min. time between start/stop, Max. number of starts/hour, Number of standby pumps, Forced pump changeover, Pump test run, Pump stop attempt, Pump start and stop speed, Min. performance, Compensation for pump start-up time.
- Secondary functions
Stop function, Soft pressure build-up, Digital inputs, Analog inputs, Digital outputs*, Analog outputs, Counter inputs, Emergency run, Min., max. and user-defined duty, Pump curve data, Control source, Fixed inlet pressure, Flow estimation, Reduced operation, Multisensor settings.
- Monitoring functions
Dry-running protection, Min. pressure, Max. pressure, External fault, Limit 1 exceeded, Limit 2 exceeded, Pumps outside duty range, Pressure relief, Log values, Fault, primary sensor, Non-return valve.
- Functions, CU 352
Display language, Units, Date and time, Password, Ethernet, GENIbus number Software status, Display 1, Display 2, Display 3.
- The service language, English, can be selected for service purposes. All these functions are usually set correctly when the system is switched on.

9.7.1 Primary controller (4.1)

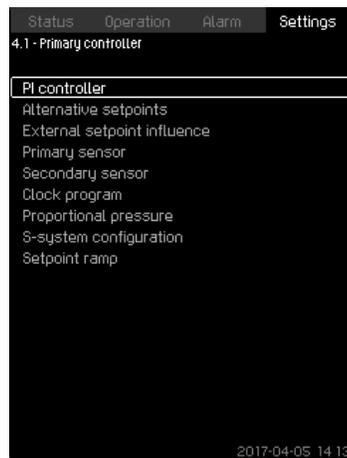

Fig. 44 Primary controller

Description

In this menu, you can set the functions related to the primary controller. It is only necessary to make settings in this menu if the functionality is to be expanded with one of the functions below:

- PI controller
- Alternative setpoints
- External setpoint influence
- Primary sensor
- Secondary sensor
- Clock program
- Proportional pressure
- S-system configuration.

9.7.2 PI controller (4.1.1)

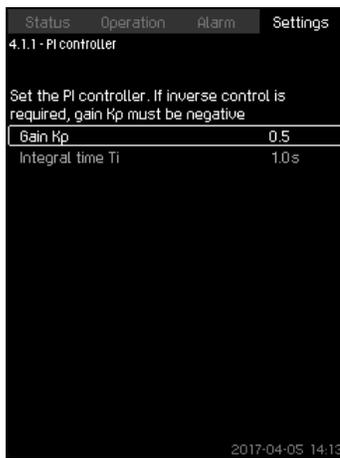

Fig. 45 PI controller

Description

The system includes a standard PI controller which ensures that the pressure is stable and corresponds to the setpoint.

You can adjust the PI controller if a faster or slower reaction to changes of consumption is required.

To obtain a faster reaction, increase Kp and reduce Ti.

To obtain a slower reaction, reduce Kp and increase Ti.

Setting range

- "Gain Kp": -30 to 30.
Note: For inverse control, set Kp to a negative value.
- "Integral time Ti": 0.1 to 3600 seconds.

Setting via the operating panel

- Settings
 - Primary controller
 - PI controller.
1. Set "Gain Kp" and "Integral time Ti".
Note: Usually it is not necessary to adjust Kp.

Factory setting

The setting of Kp and Ti depends on the system and application.

PI controller settings for pressure boosting

If the application has been set to pressure boosting in the startup wizard, the following values of Kp and Ti are set automatically:

- Kp: 0.5
- Ti: 1 second.

PI controller settings for heating and cooling

If another application than pressure boosting has been selected in the startup wizard, the values of Kp and Ti are set automatically according to the table below. As the system does not know the pipe length, the default parameters are set according to the table to a pipe length (L1 or L2) of 16 ft (5 m).

System/application	Kp		Ti [seconds]
	Heating system ¹⁾	Cooling system ²⁾	
	0.5		1
	0.5		L1 < 16 ft(5 m): 1 L1 > 16 ft(5 m): 3 L1 > 33 ft (10 m): 5
	0.5		1
	0.5	-0.5	10 + 5L2
	0.5		10 + 5L2
	0.5	-0.5	30 + 5L2

1) Heating systems are systems in which an increase in pump performance will result in a temperature rise at the sensor.

2) Cooling systems are systems in which an increase in pump performance will result in a temperature drop at the sensor.

L1: Distance [ft (m)] between pump and sensor.

L2: Distance [ft (m)] between heat exchanger and sensor.

ΔP: Measurement of differential pressure.

Q: Measurement of flow rate.

t: Measurement of temperature.

Δt: Measurement of differential temperature.

9.7.3 Alternative setpoints (4.1.2)

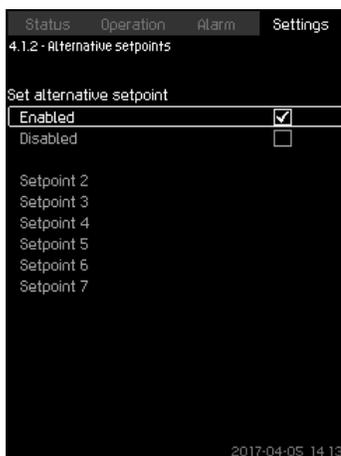

Fig. 46 Alternative setpoints

Description

This function allows you to select up to six setpoints (2 to 7) as alternatives to the primary setpoint (1). The primary setpoint (1) is set in the menu "Operation".

Every alternative setpoint can be addressed manually to a separate digital input (DI). When the contact of the input is closed, the alternative setpoint applies.

If more than one alternative setpoint has been selected, and they are activated at the same time, CU 352 selects the setpoint with the lowest number.

Setting range

- Six setpoints, numbers 2 to 7.

Factory setting

No alternative setpoints have been selected.

9.7.4 Alternative setpoints 2-7 (4.1.2.1 - 4.1.2.7)

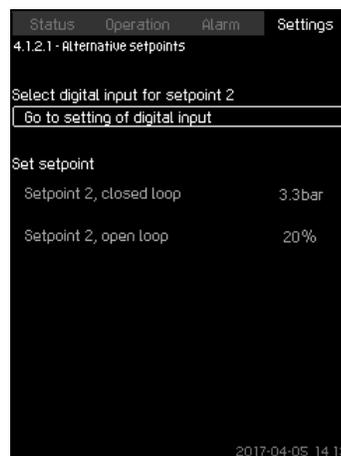

Fig. 47 Alternative setpoints 2-7

For each alternative setpoint, select the digital input to activate the setpoint.

You can set a setpoint for closed loop and for open loop.

Setting via the operating panel

- Settings > Primary controller > Alternative setpoints.
 1. Select alternative setpoint.
 2. Select: Go to setting of digital input.
Display *Digital inputs (4.3.7)* appears.
 3. Set the input.
 4. Press \leftarrow .
 5. Select the menu line of the setpoint (closed or open loop).
 6. Set the setpoint.
Set both setpoints if the system is to be controlled both in open and closed loop.

Factory setting

No alternative setpoints have been set.

9.7.5 External setpoint influence (4.1.3)

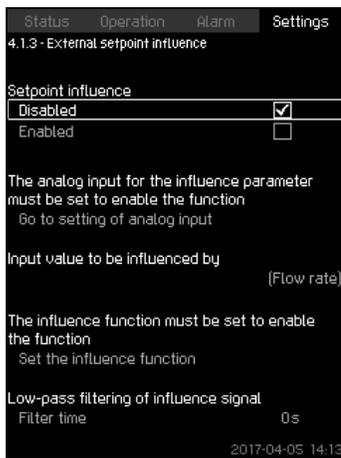

Fig. 48 External setpoint influence

Description

This function allows you to adapt the setpoint by letting measuring parameters influence the setpoint. Typically an analog signal from a flow or temperature transmitter, or a similar transmitter. For an overview of transmitter types and possible positions, see installation and operating instructions for Control MPC.

As an example, the setpoint can be adapted to parameters that can influence the outlet pressure or temperature of the system. The parameters which influence the performance of the system are shown as a percentage from 0 to 100 %. They can only reduce the setpoint, as the influence as a percentage divided with 100 is multiplied with the setpoint:

Actual setpoint (SP) = selected setpoint x influence (1) x influence (2) x etc.

The influence values can be set individually.

A low-pass filter ensures smoothing of the measured value which influences the setpoint. This results in stable setpoint changes.

Setting range

- 0-100 % signal
- Inlet pressure
- Outlet pressure
- External pressure
- Diff. pressure, external
- Diff. pressure, pump
- Flow rate
- Tank level, outlet side
- Tank level, suction side
- Return-pipe temp., external
- Flow-pipe temperature
- Return-pipe temperature
- Differential temperature
- Ambient temperature
- Differential temperature.

Setting via the operating panel

- Settings > Primary controller > External setpoint influence > Input value to be influenced by.
A list of available parameters appears.
1. Select the parameter which is to influence the setpoint.
 2. Press \leftarrow .
 3. Set the influence function.
See section [9.7.6 Setting of influence function \(4.1.3.2\)](#).
 4. Set the number of points.
 5. Set: External input value (Point 1).
 6. Set as a percentage: Reduce setpoint to (Point 1).
 7. Repeat steps 4 to 6 for all desired parameters.
 8. Press \leftarrow .
 9. Set as seconds: Filter time.
 10. Select: Enabled.

Factory setting

The function is disabled.

9.7.6 Setting of influence function (4.1.3.2)

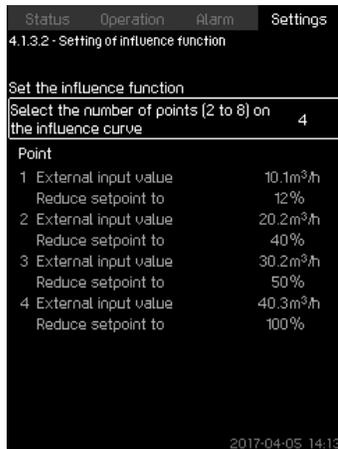

Fig. 49 Setting of influence function

Description

You can select the relation between the measuring parameter which is to influence the setpoint and the desired influence as a percentage.

The relation is set by entering values in a table with maximum eight points by means of the operating panel.

Example:

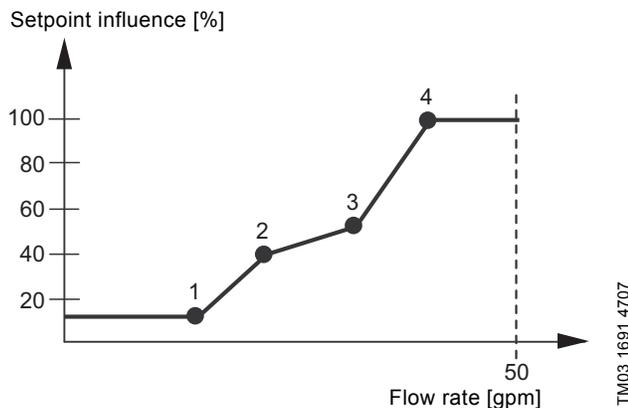

Fig. 50 Relation between setpoint influence and flow rate

The control unit draws straight lines between the points. A horizontal line is drawn from the minimum value of the relevant sensor (0 gpm in the example) to the first point. This is also the case from the last point to the sensor's maximum value (example 50 gpm).

Setting range

Two to eight points can be selected. Each point contains the relation between the value of the parameter which is to influence the setpoint and the influence of the value.

Setting via the operating panel

- Settings > Primary controller > External setpoint influence.
1. Set the influence function.
 2. Set the number of points.
 3. Set: External input value (Point 1).
 4. Set as a percentage: Reduce setpoint to (Point 1).
 5. Repeat steps 2 to 4 for all desired parameters.

Factory setting

The function is disabled.

9.7.7 Primary sensor (4.1.4)

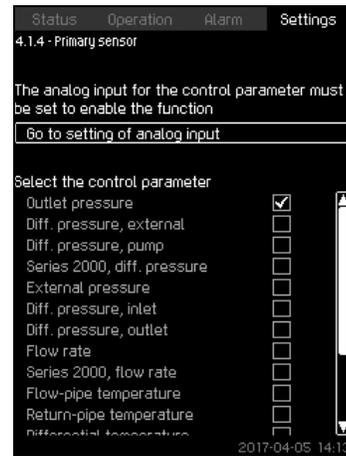

Fig. 51 Primary sensor

Description

You can select the control parameter of the system and set the sensor to measure the value.

Setting range

- Outlet pressure
- Diff. pressure, external
- Diff. pressure, pump
- Series 2000, diff. pressure
- External pressure
- Diff. pressure, inlet
- Diff. pressure, outlet
- Flow rate
- Series 2000, flow rate
- Flow-pipe temperature
- Return-pipe temperature
- Differential temperature
- Ambient temperature
- Return-pipe temp., external
- 0-100 % signal
- Not used.

Setting via the operating panel

- Settings > Primary controller > Primary sensor > Go to setting of analog input.
Display [Analog inputs \(4.3.8\)](#) appears.
1. Select analog input (AI) for the primary sensor and set the parameters.
 2. Press **↵**.
 3. Select control parameter for the primary sensor.

Factory setting

The primary parameter is the outlet pressure. The sensor is connected to AI1 (CU 352). Other primary parameters can be selected in the startup wizard.

9.7.8 Secondary sensor (4.1.5)

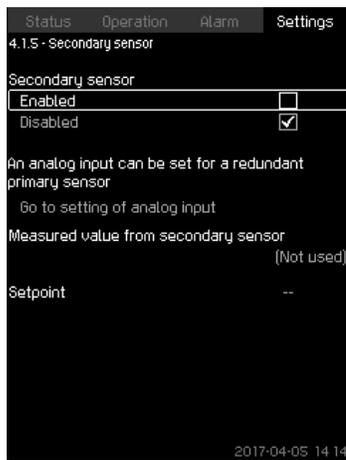

Fig. 52 Secondary sensor

Description

This function is designed for optimizing the constant-pressure control, where there is a high dynamic friction loss. The function enables the possibility of placing a primary sensor on the critical point in the system.

The sensor needs to be hardwired back to the controller, and will act as primary sensor hence utilizing the normal "Setpoint" setting.

The "Secondary sensor" is then the "local" sensor placed on the pump system manifold close to the control cabinet.

In case of a fault on the "Primary sensor", the "Secondary sensor" will automatically take over using its specified "Setpoint". The difference between the setpoint of the "Primary sensor" and the "Secondary sensor" is equal to the total pressure losses in between the two sensors at maximum flow.

Setting range

- Enabled or Disabled function
- 1. Setting of analog input
- 2. Setting of "Measured value from secondary sensor"
- 3. Setting of "Setpoint"

Settings via the operating panel

- Settings > Primary controller > Secondary sensor
- 1. Enable the function.
- 2. Define the analog input used for "Secondary sensor".
- 3. Define "Measured value from secondary sensor".
- 4. Define "Setpoint" for "Secondary sensor" operation.

9.7.9 Clock program (4.1.6)



Fig. 53 Clock program

Description

With this function, you can set setpoints and day and time for their activation. You can also set day and time for stop of the system.

If the clock program is disabled, the setpoint of the program will remain active.



Minimum two events are required when activating the clock program: one to start the system and one to stop the system.

Setting range

- Activation and setting of event.

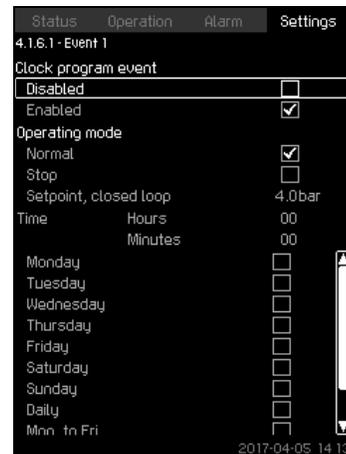

Fig. 54 Event 1

Setting via the operating panel

- Settings > Primary controller > Clock program.
1. Enable the function.
 2. Select and enable one of the ten events.
 3. Select: Normal or Stop. Skip step 4 if you select "Stop".
 4. Set: Setpoint, closed loop.
 5. Set: Time, Hours, Minutes.
 6. Select the day of week on which the settings are to be activated.
 7. Select: Enabled.
 8. Repeat steps 2 to 7 if several events are to be enabled.
Note: Up to ten events can be set.
 9. Press .
 10. Select: Enabled.

Factory setting

The function is disabled.

9.7.10 Proportional pressure (4.1.7)

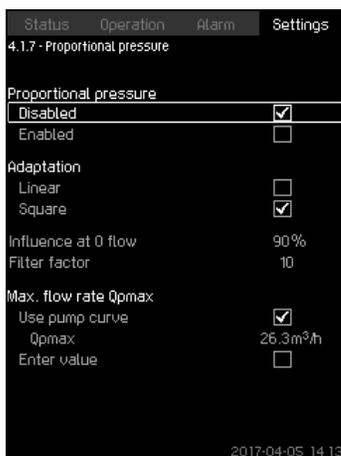
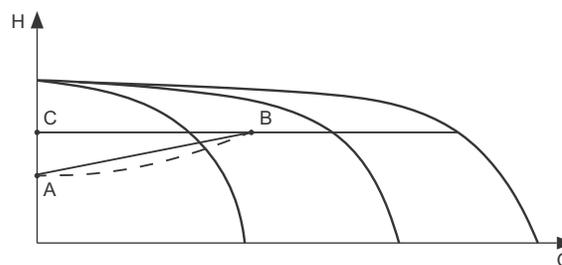

Fig. 55 Proportional pressure

Description

The function can only be enabled in pressure-controlled systems and it automatically adapts the setpoint to the actual flow rate to compensate for flow-dependent dynamic losses. As many systems are designed with extra flow capacity, the estimated maximum flow rate (Q_{pmax}) can be entered manually. In systems with CR pumps, the pump curves can be used to calculate the maximum flow rate at the selected setpoint. Set a filter factor to prevent fluctuation.

The adaptation can be linear or square. See fig. 55.



TM05 3005 0812

Fig. 56 Proportional pressure

Pos.	Description
A	Pressure at zero flow. Starting point of proportional-pressure control (influence at zero flow = x % of setpoint)
B	Q_{pmax}
C	Setpoint

The function has these purposes:

- to compensate for pressure losses
- to reduce the energy consumption
- to increase the comfort for the user.

Setting range

- Selection of control mode
- Influence at 0 flow
- Estimated flow rate
- Filter factor.

Setting via the operating panel

- Settings > Primary controller > Proportional pressure.
1. Select: Enabled.
 2. Select:
 - Adaptation
 - Linear or Square.
 3. Set: Influence at 0 flow.
 4. Set: Filter factor.
 5. Select: Use pump curve or Enter value.
 6. Set " Q_{pmax} " if you select "Enter value".

Factory setting

The function is disabled.

9.7.11 S-system configuration (4.1.8)

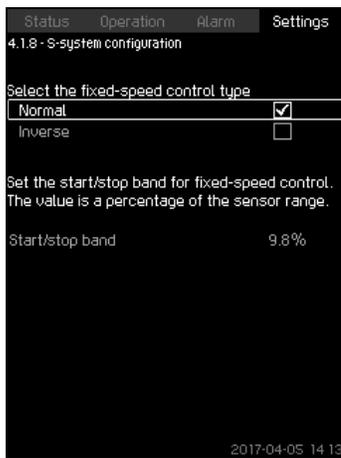

Fig. 57 S-system configuration

Description

The function allows you to invert the control of mains-operated pumps (MPC-S). That is, to set whether pumps are to be started or stopped depending on the actual value.

A start/stop band must be set in order to use this function. See fig. 58.

Normal

A pump is stopped when the value becomes higher than Hset + start/stop band. And a pump is started when the value becomes lower than Hset. See fig. 58.

Inverse

A pump is started when the value becomes higher than Hset + start/stop band. And a pump is stopped when the value becomes lower than Hset. See fig. 58.

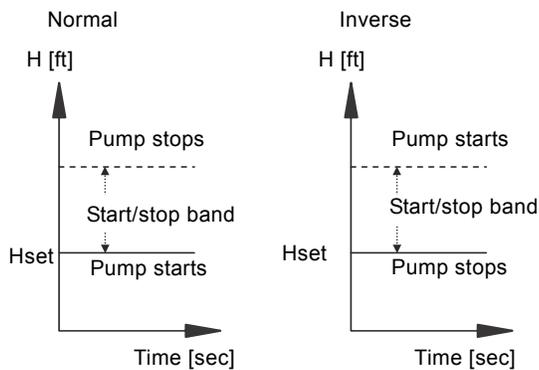

Fig. 58 Normal and inverse control

Setting range

- Selection of configuration (normal or inverse).
- Start/stop band.

Setting via the operating panel

- Settings > Primary controller > S-system configuration.
1. Select: Normal or Inverse.
 2. Set: Start/stop band.

Factory setting

Normal.

9.7.12 Setpoint ramp (4.1.9)

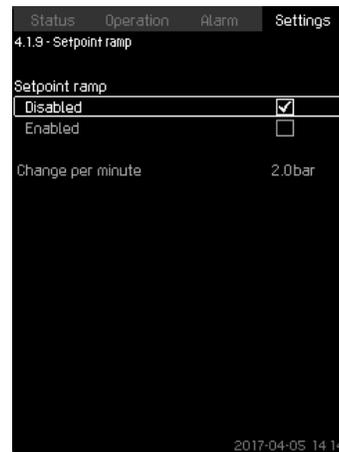

Fig. 59 Setpoint ramp

Description

When this function is enabled, setpoint changes are affected by the setpoint ramp, and the setpoint changes gradually over a period of time.

"Proportional pressure" or "Setpoint influence" are not affected by this function.

Setting range

The function can be enabled and "Change per minute" can be set.

Setting via the operating panel

- Settings > Primary controller > Setpoint ramp.
1. Select: Enabled.
 2. Set: Change per minute.

Factory setting

The function is disabled.

9.7.13 Pump cascade control (4.2)

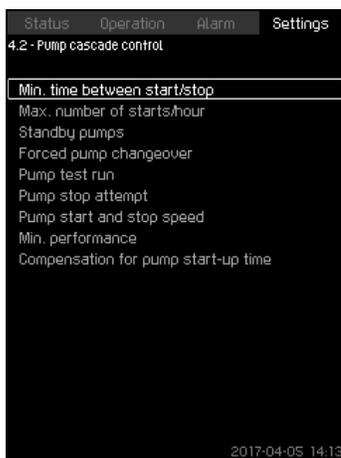

Fig. 60 Pump cascade control

In this menu, you can set the functions connected to pump cascade control.

The following menus can be selected:

- Min. time between start/stop
- Max. number of starts/hour
- Standby pumps
- Forced pump changeover
- Pump test run
- Pilot pump
- Pump stop attempt
- Pump start and stop speed
- Min. performance
- Compensation for pump start-up time.

9.7.14 Min. time between start/stop (4.2.1)

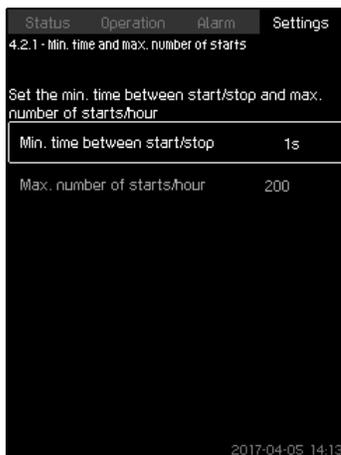

Fig. 61 Min. time between start/stop

Description

This function ensures a delay between the starting and stopping of one pump and the starting and stopping of another pump.

The purpose is to prevent hunting when pumps start and stop continuously.

Setting range

From 1 to 3600 seconds.

Setting via the operating panel

Settings > Pump cascade control > Min. time between start/stop.

Factory setting

The setting is done in the startup wizard and depends on the application.

9.7.15 Max. number of starts/hour (4.2.1)

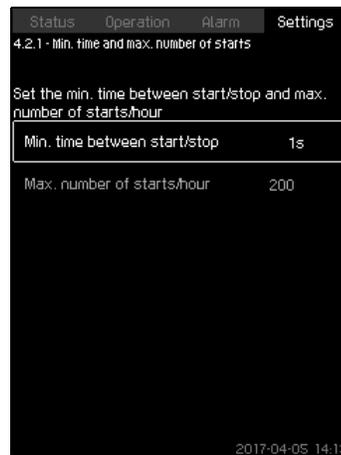

Fig. 62 Max. number of starts/hour

Description

This function limits the number of pump starts and stops per hour for the complete system. It reduces noise emission and improves the comfort of systems with mains-operated pumps.

Each time a pump starts or stops, CU 352 calculates when the next pump is allowed to start/stop in order not to exceed the permissible number of starts per hour.

The function always allows pumps to be started to meet the requirement, but pump stops will be delayed, if needed, in order not to exceed the permissible number of starts per hour.

The time between pump starts must be between the minimum time between start and stop, see section 9.7.14, and $3600/n$, n being the set number of starts per hour.

Setting range

1 to 1000 starts per hour.

Setting via the operating panel

- Settings > Pump cascade control > Max. number of starts/hour.
1. Set:
 - Min. time between start/stop.
 - Max. number of starts/hour.

Factory setting

MPC-E: 200 starts per hour
Other variants: 100 starts per hour



This function has no influence on [Stop function \(4.3.1\)](#).

9.7.16 Standby pumps (4.2.3)

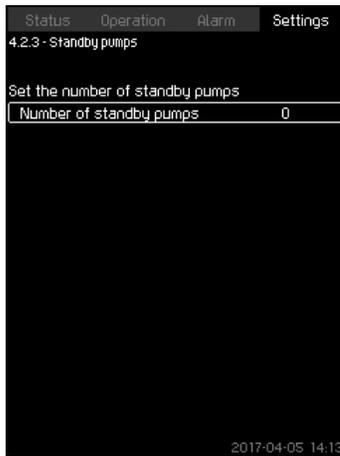

Fig. 63 Standby pumps

Description

This function allows you to limit the maximum performance of the system, by selecting one or more pumps as standby pumps.

If a three-pump system has one standby pump, maximum two pumps are allowed to be in operation at a time.

If one of the two pumps in operation has a fault and has stopped, the standby pump will be started. The performance of the system is thus not reduced.

The status as standby pump alternates between all pumps.

Setting range

The number of possible standby pumps in a system is equal to the total number of pumps in the system minus 1.

Setting via the operating panel

- Settings > Pump cascade control > Standby pumps.
- Set: Set the number of standby pumps.

Factory setting

The number of standby pumps is set to zero. The function is disabled.

9.7.17 Forced pump changeover (4.2.4)

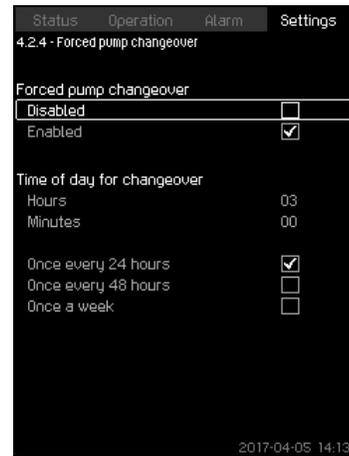

Fig. 64 Forced pump changeover

Description

This function ensures that the pumps run for the same number of operating hours.

In certain applications, the requirement remains constant for long periods and does not require all pumps to run. In such situations, pump changeover does not take place naturally, and forced pump changeover may thus be required.

Once every 24 hours, CU 352 checks if any pump running has a larger number of operating hours than pumps that are stopped. If this is the case, the pump will be stopped and replaced by a pump with a lower number of operating hours.

Setting range

You can enable and disable the function. You can set the hour of the day at which the changeover is to take place.

Setting via the operating panel

- Settings > Pump cascade control > Forced pump changeover.
1. Select: Enabled.
 2. Set: Time of day for changeover.
 3. Select interval for pump changeover.

Factory setting

The function is enabled. The time is set to 03:00.

9.7.18 Pump test run (4.2.5)

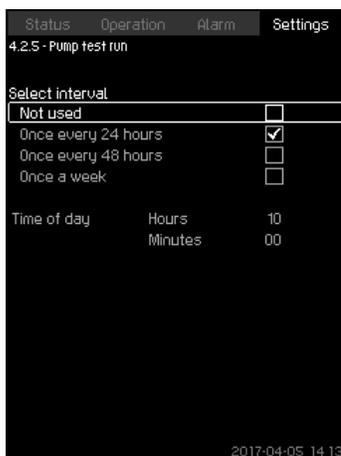

Fig. 65 Pump test run

Description

This function is primarily used in situations where the forced pump changeover is disabled, and/or if the system is set to operating mode "Stop", for instance in a period when the system is not needed. In such situations, it is important to test the pumps regularly.

Advantages of this function:

- Pumps do not seize up during a long standstill due to deposits from the pumped liquid.
- The pumped liquid does not decay in the pump.
- Trapped air is removed from the pump.

The pumps start automatically one by one and run for five seconds.



Pumps in operating mode "Manual" are not included in the test run. If there is an alarm, the test run will not be carried out.

Setting range

- Time of day
- Day of week
- Include pilot pump.

Setting via the operating panel

- Settings > Pump cascade control > Pump test run.
1. Select interval.
 2. Set:
 - Time of day
 - Minutes.
 3. Select the day of week if you select "Once a week".
 4. If the system is configured with a pilot or a backup pump, select "Include pilot pump".

Factory setting

The function is disabled.

9.7.19 Pump stop attempt (4.2.7)

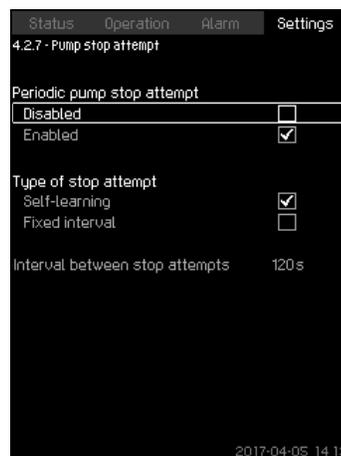

Fig. 66 Pump stop attempt

Description

The function allows you to set automatic stop attempts of a pump when several pumps are running. It ensures that the optimum number of pumps is always running, in terms of energy consumption. See section [9.7.20 Pump start and stop speed \(4.2.8\)](#). At the same time, the purpose is to avoid disturbances in connection with automatic stop of pumps.

Stop attempts can either take place with a fixed interval set under "Interval between stop attempts" or by self-learning. If self-learning is selected, the interval between stop attempts will be increased if repeated attempts to stop the pump fail.

Setting via the operating panel

- Settings > Pump cascade control > Pump stop attempt.
1. Select: Self-learning or Fixed interval.
 2. Set "Interval between stop attempts" if you select "Fixed interval".
 3. Select: Enabled.

Factory setting

The function is enabled, and "Self-learning" is selected.

9.7.20 Pump start and stop speed (4.2.8)

Description

The function controls the starting and stopping of pumps. There are two options:

1. Use calculated speed

This function ensures that the optimum number of pumps is always running at a desired duty point, in terms of energy consumption. CU 352 calculates the required number of pumps and their speed. This requires that the differential pressure of the pump is measured by a differential-pressure sensor or separate pressure sensors on the inlet and outlet side. If calculated speed has been selected, CU 352 ignores the percentages set.

2. Use fixed speed

The pumps are started and stopped at speeds set by the user.

1. Use calculated speed

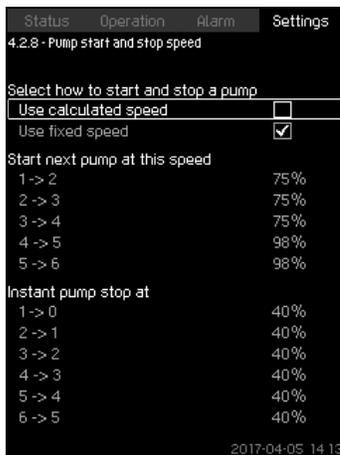

Fig. 67 Use calculated speed

Setting via the operating panel

- Settings > Pump cascade control > Pump start and stop speed > Use calculated speed.

2. Use fixed speed

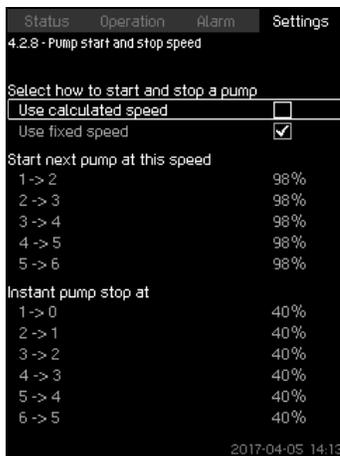

Fig. 68 Use fixed speed

Setting via the operating panel

- Settings > Pump cascade control > Pump start and stop speed.
- Select: Use fixed speed.
- Set: Start next pump at this speed > 1 -> 2.

- Set the speed as percentage.
- Set the other pumps in the same way.
- Select: Instant pump stop at > 1 -> 0.
- Set the speed as percentage.
- Set the other pumps in the same way.

Factory setting

The function is set to calculated speed.

9.7.21 Min. performance (4.2.9)

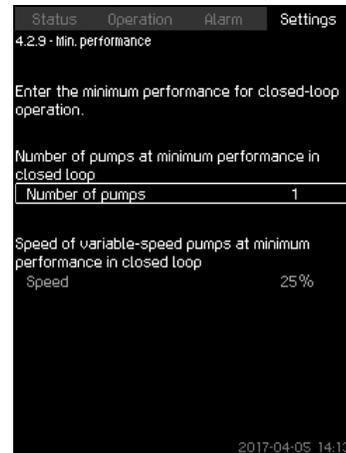

Fig. 69 Min. performance

Description

This function ensures circulation in a system. Note that the stop function, if enabled, can influence this function. See section [9.7.24 Stop function \(4.3.1\)](#). Examples:

- If zero pumps have been selected, the stop function can stop the pump if there is no or a very small consumption.
- If pumps have been selected, the stop function will not be active.

Setting via the operating panel

- Settings > Pump cascade control > Min. performance.
- Set:
 - Number of pumps
 - Speed.

Factory setting

The number of pumps is set to zero. The speed in closed loop is set to 25 %.

9.7.22 Compensation for pump start-up time (4.2.10)

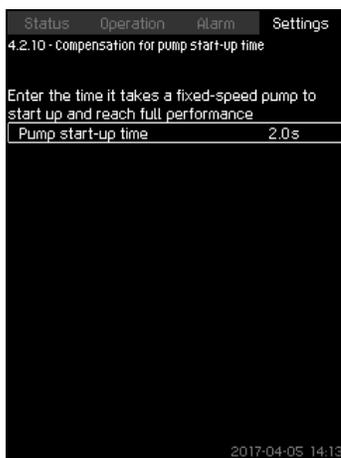

Fig. 70 Compensation for pump start-up time

Description

The function is used for MPC-F systems only.

The purpose is to avoid disturbances when a mains-operated pump with fixed speed is started. The function compensates for the time it takes a mains-operated pump to reach its full performance after start. The startup time of the mains-operated pump must be known.

Setting via the operating panel

- Settings > Pump cascade control > Compensation for pump start-up time.
- Set: Pump start-up time

Factory setting

The startup time is set to zero seconds.

9.7.23 Secondary functions (4.3)

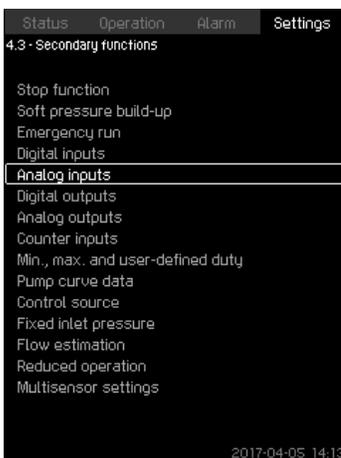

Fig. 71 Secondary functions

Description

In this display, you can set functions that are secondary in relation to the normal operation of the system. Secondary functions are functions that offer additional functionality.

The display allows you to open these specific displays:

- [Stop function \(4.3.1\)](#)
- [Soft pressure build-up \(4.3.3\)](#)
- [Digital inputs \(4.3.7\)](#)
- [Analog inputs \(4.3.8\)](#)
- [Digital outputs \(4.3.9\)](#)
- [Analog outputs \(4.3.10\)](#)
- [Counter inputs \(4.3.11\)](#)
- [Emergency run \(4.3.5\)](#)
- [Min., max. and user-defined duty \(4.3.14\)](#)
- [Pump curve data \(4.3.19\)](#)
- [Flow estimation \(4.3.23\)](#)
- [Control source \(4.3.20\)](#)
- [Fixed inlet pressure \(4.3.22\)](#)
- [Flow estimation \(4.3.23\)](#)
- [Reduced operation \(4.3.24\)](#)
- [Multisensor settings \(4.3.25\)](#)

9.7.24 Stop function (4.3.1)

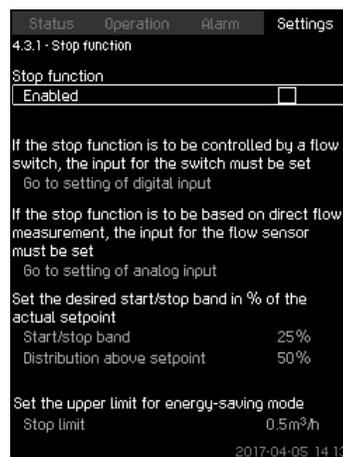

Fig. 72 Stop function

Description

This function is typically used in constant-pressure applications and allows you to stop the last pump if there is no or a very small consumption.

Purpose of the function:

- to save energy
- to prevent heating of shaft seal faces due to increased mechanical friction as a result of reduced cooling by the pumped liquid
- to prevent heating of the pumped liquid.

The description of the stop function applies to all pump systems with variable-speed pumps. MPC-S systems will have on/off control of all pumps as described in section 7. [Overview of control variants](#).

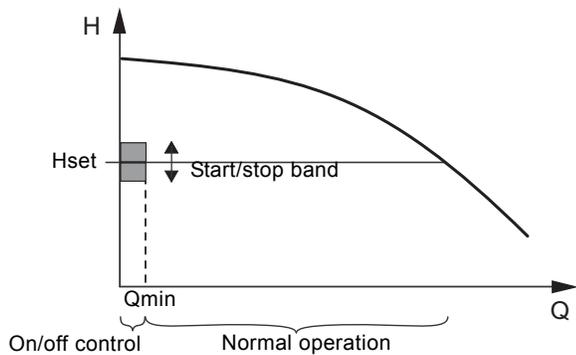

Fig. 73 Start/stop band

When the stop function is enabled, the operation is continuously monitored to detect a low flow rate. When CU 352 detects no or a low flow rate ($Q < Q_{min}$), it changes from constant-pressure operation to on/off control of the last pump in operation.

Before stopping, the pump increases the pressure to a value corresponding to H_{set} plus (distribution above setpoint / 100) x start/stop band. The pump is restarted when the pressure is H_{set} minus (100-distribution above setpoint) / 100 x start/stop band. See fig. 74. The start/stop band can be distributed around the setpoint.

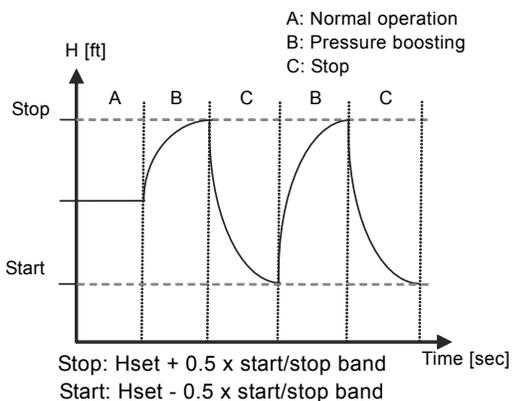

Fig. 74 On/off operation

The flow rate is estimated by CU 352 when the pump is in the stop period. As long as the flow rate is lower than Q_{min} , the pump will run on/off. If the flow rate is increased to above Q_{min} , the pump returns to normal operation, H_{set} . H_{set} is equal to the actual setpoint. See section 9.4.4 [Setpoint \(1.2.2\)](#).

Detection of low flow rate

Low flow rate can be detected in two ways:

- direct flow measurement with a flowmeter or flow switch
- estimation of flow rate by measurement of pressure and speed.

If the pump system is not connected to a flowmeter or flow switch, the stop function will use the estimating function.

If the detection of low flow rate is based on flow estimation, a diaphragm tank of a certain size and with a certain precharge pressure is required.

Selection of diaphragm tank size

Pump type	Recommended diaphragm tank size [gal (L)]		
	-E	-F	-S
CRI(E) 3	4.4 (17)	4.4 (17)	20 (76)
CRI(E) 5	4.4 (17)	4.4 (17)	34 (129)
CRI(E) 10	10.2 (39)	10.2 (39)	62 (235)
CRI(E) 15	34 (129)	34 (129)	211 (799)
CRI(E) 20	34 (129)	34 (129)	211 (799)
CR(E) 32	44 (167)	44 (167)	317 (1200)
CR(E) 45	86 (326)	86 (326)	528 (1999)
CR(E) 64	132 (500)	132 (500)	1056 (3997)
CR(E) 950	132 (500)	132 (500)	1056 (3997)
CR(E) 125	211 (799)	211 (799)	(2) x 1056 (3997)
CR(E) 155	211 (799)	211 (799)	(2) x 1056 (3997)

We recommend that the Hydro MPC CME pump sets are equipped with a diaphragm tank due to the stop function. Hydro MPC CME systems with the following pump types on system have the corresponding recommended diaphragm tank size:

Recommended diaphragm tank size [gal (L)]	
Pump type	Tank size
CME 3	4.4 (17)
CME 5	4.4 (17)
CME 10	10.3 (39)
CME 15	34 (129)
CME 25	34 (129)

Precharge pressure

Hydro MPC-E and -F: 0.7 x setpoint.

Hydro MPC-S: 0.9 x setpoint.

During each flow estimation (every 2 minutes), the estimating function will disturb the outlet pressure by $\pm 10\%$ of the setpoint. If this disturbance is not acceptable, the stop function must be based on direct flow measurement with a flowmeter or flow switch.

The minimum flow rate can be set, that is the flow rate at which the pump system changes to on/off control of the last pump in operation.

If both a flowmeter and a flow switch are connected, the changeover to on/off control will be determined by the unit first indicating low flow rate.

Setting range

Start/stop band:	5-30 %
Minimum flow rate:	2-50 % of the rated flow rate (Qnom) of one of the pumps. (It can only be set if direct flow measurement by means of flowmeter has been selected.)
Distribution above setpoint:	0-100 %.

Setting via the operating panel

System without flow switch or flowmeter

- Settings > Secondary functions > Stop function.
- Select: Enabled.
- 1. Set: Start/stop band.
- 2. Select: Go to setting of flow stop parameters. The display below appears.

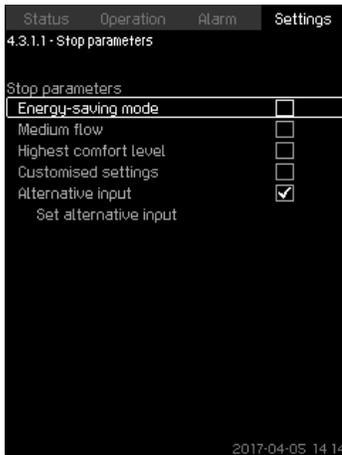

Fig. 75 Stop parameters

- 3. Select one of the stop parameters. If you select "Customised settings", you must set the parameters shown in fig. 76. See the examples below.

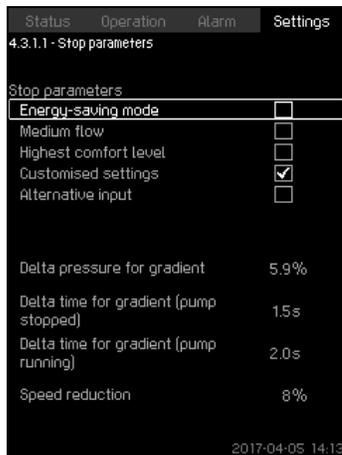

Fig. 76 Customised settings



Rule of thumb: Speed reduction = 2 x delta pressure for gradient.

Example 1: Increasing the stop limit, Qmin (high flow limit)

- Increase "Delta pressure for gradient".
- Reduce "Delta time for gradient (pump stopped)".
- Reduce "Delta time for gradient (pump running)".
- Increase "Speed reduction".

Example of increased stop limit

Parameter	Value
Delta pressure for gradient	6 %
Delta time for gradient (pump stopped)	1.5 seconds
Delta time for gradient (pump running)	2.0 seconds
Speed reduction	10 %

Example 2: Reducing the stop limit, Qmin (low flow limit)

- Reduce "Delta pressure for gradient".
- Increase "Delta time for gradient (pump stopped)".
- Increase "Delta time for gradient (pump running)".
- Reduce "Speed reduction".

Example of reduced flow limit

Parameter	Value
Delta pressure for gradient	3 %
Delta time for gradient (pump stopped)	15.0 seconds
Delta time for gradient (pump running)	25.0 seconds
Speed reduction	6 %



The stop limit depends on the tank size.

Alternative input

If you select "Alternative input", the controller calculates the stop parameters based on the following inputs:

- system set-point
- total tank volume
- precharge pressure
- desired stop flow.

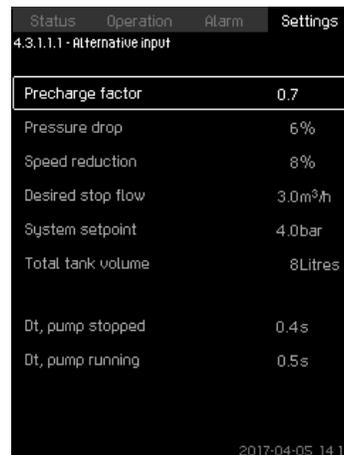

Fig. 77 Alternative input

System with flow switch

Make the following additional settings:

1. Select: Go to setting of digital input.
Display *Digital inputs (4.3.7)* appears.
2. Select the digital input where the flow switch is connected.
3. Select: Flow switch.
4. Press \leftarrow .



An open contact indicates low flow.

System with flowmeter

Make the following additional settings:

1. Select: Go to setting of analog input.
Display *Analog inputs (4.3.8)* appears.
2. Select the analog input where the flowmeter is connected.
3. Select: Flow rate.
4. Press \leftarrow x 2.
5. Set: Stop limit.



As standard, there is a 10-seconds detection hysteresis. It can be adjusted with PC-Tool E-products.

Factory setting

The function is enabled in pressure-boosting applications with the settings in the table.

Start/stop band:	25 %
Min. flow rate:	30 % of the rated flow rate of one pump
Distribution above setpoint:	50 %

The function is disabled in all other applications.

9.7.25 Soft pressure build-up (4.3.3)

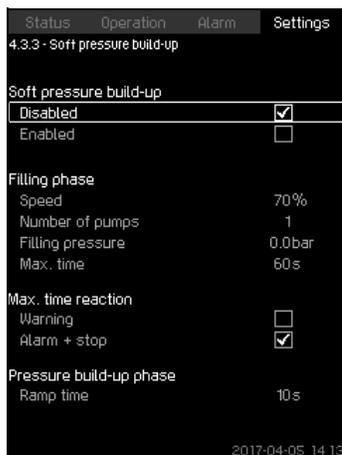

Fig. 78 Soft pressure build-up

Description

This function is typically used in pressure-boosting applications and ensures a smooth startup of systems with for instance empty pipes.

Startup takes place in two phases. See fig. 79.

1. Filling phase
The pipes are slowly filled with water. When the pressure sensor of the system detects that the pipes have been filled, phase two begins.
2. Pressure build-up phase
The system pressure is increased until the setpoint is reached. The pressure buildup takes place over a ramp time. If the setpoint is not reached within a given time, a warning or an alarm can be given, and the pumps can be stopped at the same time.

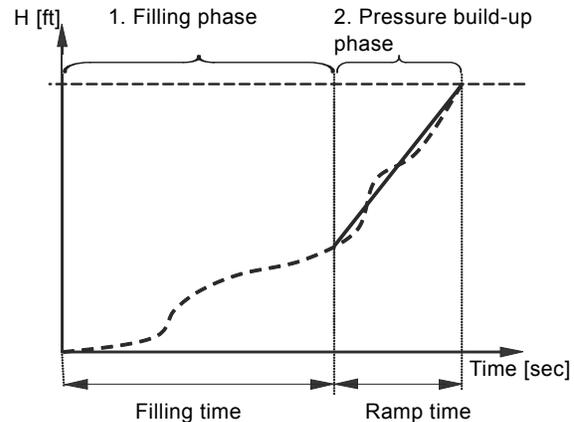

Fig. 79 Filling and pressure buildup phases

Setting range

- Pump speed
- Number of pumps
- Filling pressure
- maximum filling time
- Warning or Alarm + stop
- "Ramp time" for "Pressure build-up phase".

Setting via the operating panel

- Settings > Secondary functions > Stop function > Soft pressure build-up.
1. Select and set:
 - Speed
 - Number of pumps
 - Filling pressure
 - Max. time.
 2. Select: Warning or Alarm + stop.
 3. Set: Ramp time.
 4. Select: Enabled.

Factory setting

The function is disabled.

9.7.26 Emergency run (4.3.5)

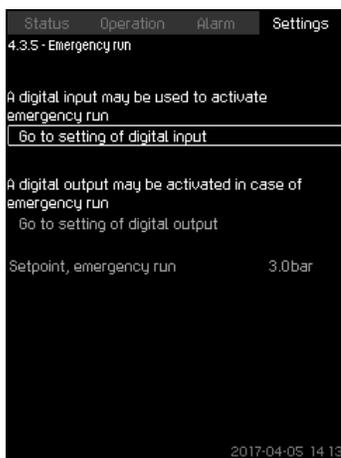

Fig. 80 Emergency run

Description

This function is used in boosting applications. When this function has been enabled, the pumps will keep running regardless of warnings or alarms. The pumps will run according to a setpoint set specifically for this function.



In case of sensor fault, both main and standby pumps will run at 100 % speed.

Setting range

- Setting of digital input ([9.7.27 Digital inputs \(4.3.7\)](#)).
- Setting of digital output ([9.7.32 Digital outputs \(4.3.9\)](#)).
- Setting of setpoint for emergency run.

Setting via the operating panel

- Settings > Secondary functions > Emergency run > Go to setting of digital input.
 1. Select digital input.
 2. Select: Emergency run.
 3. Press  x 2.
 4. Select: Go to setting of digital output.
 5. Select digital output.
 6. Select: Emergency run.
 7. Press  x 2.
 8. Set: Setpoint, emergency run.



When you have set this function described above, you can also enable it via the display [System operating mode \(2.1.1\)](#).

9.7.27 Digital inputs (4.3.7)

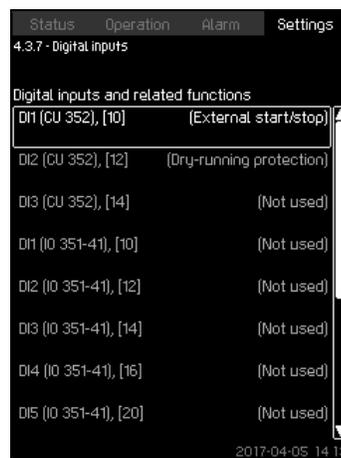

Fig. 81 Digital inputs

Description

In this menu, you can set the digital inputs of CU 352. Each input, except DI1, can be activated and related to a certain function.

As standard, the system has three digital inputs. If the system incorporates an IO 351B module (option), the number of digital inputs is 12.

All digital inputs are shown so that their physical position in the system can be identified.

Example

DI1 (IO 351-41), [10]:

DI1:	Digital input No 1
(IO 351-41):	IO 351, GENIbus number 41
[10]:	Terminal No 10

For further information on the connection of various digital inputs, see the wiring diagram supplied with the control cabinet.

Setting range



DI1 (CU 352) cannot be selected.

Setting via the operating panel

- Settings > Secondary functions > Digital inputs.

9.7.28 Functions of digital inputs (4.3.7.1)

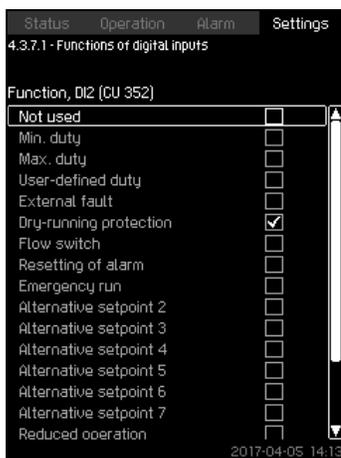

Fig. 82 Functions of digital inputs

Description

A function can be related to the digital inputs.

Setting range

You can select one function in each display:

Function	Contact activated
Not used	
Min. duty	= Operating mode "Min."
Max. duty	= Operating mode "Max."
User-defined duty	= Operating mode "User-defined"
External fault	= External fault
Dry-running protection	= Water shortage
Flow switch	= Flow
Resetting of alarm	= Alarms are reset
Emergency run	= Operating mode "Emergency run"
Fault, pilot pump	= Fault
Alternative setpoint 2-7	= The setpoint is selected
Reduced operation	= Activation of "Reduced operation"
Stop pump 1-6	= Forces the pump to stop
Stop pilot pump	= Forces the pump to stop



In the display, you can only select pumps defined in the system.

See the relevant sections for further information about the functions.

Generally, a closed contact activates the function selected.

Setting via the operating panel

- Settings > Secondary functions > Stop function > Go to setting of digital input.

Factory setting

Digital input	Function
DI1 (CU 352) [10]	External start/stop. Open contact = stop. Note: Input No 1 cannot be changed.
DI2 (CU 352) [12]	Monitoring of water shortage (dry-running protection). Open contact = water shortage (if the system is supplied with this option).



Monitoring of water shortage requires a pressure or level switch connected to the system.

9.7.29 Analog inputs (4.3.8)

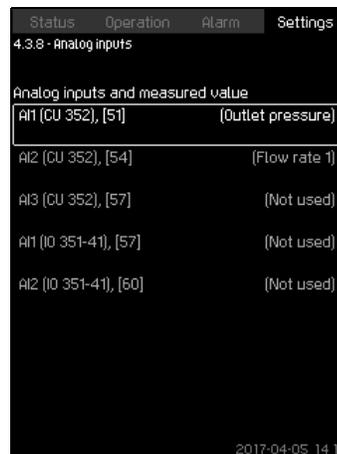

Fig. 83 Analog inputs

Description

Each analog input can be activated and related to a certain function.

As standard, the system has three analog inputs. If the system incorporates an IO 351B module (option), the number of analog inputs is 5.

All analog inputs are shown so that their physical position in the system can be identified. A redundant primary sensor can be fitted as backup for the primary sensor in order to increase reliability and prevent stop of operation.



If two sensors are to be redundant, each must have a separate analog input.

Example

AI1 (CU 352) [51]:

AI1:	Analog input No 1
(CU 352):	CU 352
[51]:	Terminal No 51

Setting via the operating panel

- Settings > Secondary functions > Stop function > Go to setting of analog input.

9.7.30 Analog inputs (4.3.8.1 to 4.3.8.7)

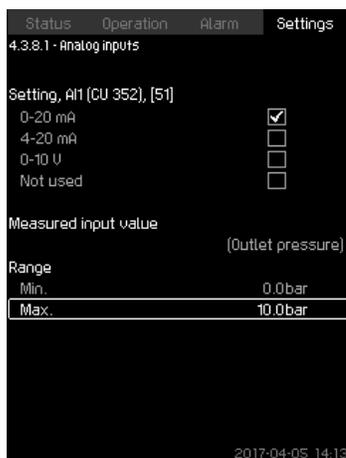

Fig. 84 Analog inputs

Description

In this menu, you can set "Analog inputs". Each display is divided into three parts:

- Setting of input signal, for instance 4-20 mA
- "Measured input value", for instance "Outlet pressure"
- Measuring range of the sensor/signal transmitter, for instance 0-232 psi (0-16 bar).

Setting range

You can set the following parameters in each display:

- Not used
- Range of input signal, 0-20 mA, 4-20 mA, 0-10 V
- Measured input value
- Sensor range.

Setting via the operating panel

- Settings > Secondary functions > Stop function > Go to setting of analog input.



If an analog input is deactivated, the display only shows the setting of the analog input.

If the input is activated, "Measured input value" is shown. This makes it possible to relate a function to the analog input in another display. When the analog input has been related to a function, CU 352 will return to the display for setting of analog inputs.

Factory setting

Pressure boosting	
Analog input	Function
AI1 (CU 352) [51]	Outlet pressure
Heating and cooling	
Analog input	Function
AI1 (CU 352) [51]	These are selected in the startup wizard

9.7.31 Analog inputs and measured value (4.3.8.1.1 - 4.3.8.7.1)

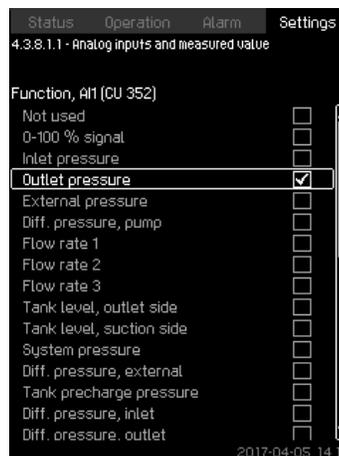

Fig. 85 Analog inputs and measured value

Description

A function can be related to the individual analog inputs.

Setting range

You can select one function per analog input. For further details, see the installation and operating instructions for Control MPC.

- Not used
- 0-100 % signal
- Inlet pressure
- Outlet pressure
- External pressure
- Diff. pressure, pump
- Flow rate 1-3
- Tank level, outlet side
- Tank level, suction side
- System pressure
- Diff. pressure, external
- Tank precharge pressure
- Diff. pressure, inlet
- Diff. pressure, outlet
- Return-pipe temp., external
- Flow-pipe temperature
- Return-pipe temperature
- Differential temperature
- Ambient temperature
- Power, pump 1-6
- Power, VFD
- Multisensor 1-6.

Setting via the operating panel



If more flow rates are used, the flow rate measured and shown is the sum of defined flow rates.

- Settings > Secondary functions > Go to setting of analog input.
 1. Select analog input.
 2. Select: Measured input value. Display 4.3.8.1.1 appears.
 3. Select input.
 4. Press ↵.
 5. Set the minimum and maximum sensor value.

9.7.32 Digital outputs (4.3.9)

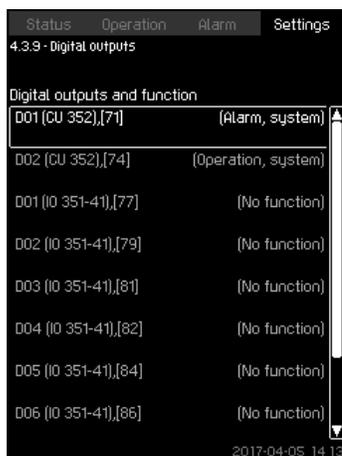

Fig. 86 Digital outputs

Description

Each digital output can be activated and related to a certain function.

As standard, the system has two digital outputs.

If the system incorporates an IO 351B module (option), the number of digital outputs is 9.

All digital outputs are shown so that their physical position in the system can be identified.

Example

DO1 (IO 351-41) [71]:

DO1	Digital output No 1
(IO 351-41)	IO 351B, GENibus number 41
[71]	Terminal No 71

For further information on the connection of various digital outputs, see the wiring diagram supplied with CU 352.

9.7.33 Function of digital outputs (4.3.9.1 - 4.3.9.16)

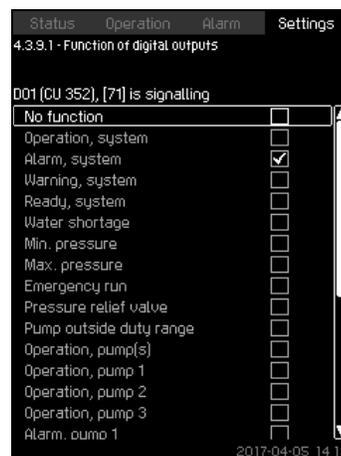

Fig. 87 Function of digital outputs

Description

A function can be related to the individual outputs.

Setting range

You can select one function in each display:

- No function
- Operation, system
- Alarm, system
- Warning, system
- Ready, system
- Water shortage
- Min. pressure
- Max. pressure
- Emergency run
- Operation, pilot pump
- Pressure relief valve
- Pump outside duty range
- Operation, pump(s)
- Operation, pump 1-6
- Alarm, pump 1
- Alarm, limit 1 exceeded
- Warning, limit 1 exceeded
- Alarm, limit 2 exceeded
- Warning, limit 2 exceeded
- Reduced operation.

Setting via the operating panel

- Settings > Secondary functions > Stop function > Go to setting of digital input.

Factory setting

Digital output	Function
DO1 (CU 352) [71]	Alarm, system
DO2 (CU 352) [74]	Operation, system

9.7.34 Analog outputs (4.3.10)

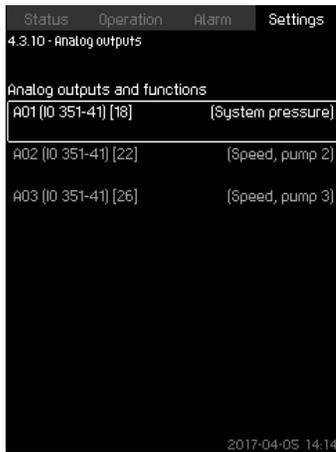

Fig. 88 Analog outputs



This display only appears if an IO 351B module is installed.

Description

CU 352 does not have analog outputs as standard, but the system can be fitted with an IO 351B module with three analog outputs.

Setting via the operating panel

- Settings > Secondary functions > Analog outputs.

9.7.35 Output signal (4.3.10.1 - 4.3.10.3)

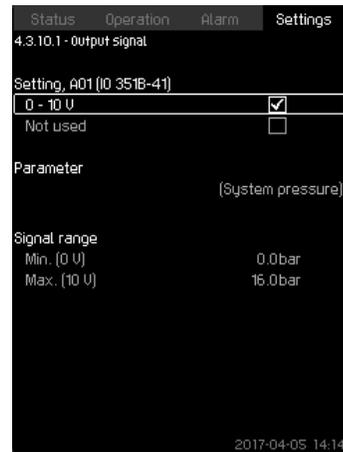

Fig. 89 Output signal

Description

You can select the parameters below.

Setting range

- 0-100 % signal
- Flow rate 1-6
- Inlet pressure
- Outlet pressure
- External pressure
- Diff. pressure, pump
- Tank level, outlet side
- Tank level, suction side
- System pressure
- Diff. pressure, external
- Tank precharge pressure
- Diff. pressure, inlet
- Diff. pressure, outlet
- Return-pipe temp., external
- Flow-pipe temperature
- Return-pipe temperature
- Differential temperature
- Ambient temperature
- System power
- Power, pump 1-6
- Power, pilot pump
- Power, VFD
- Speed, pump 1-6
- Speed, pilot pump
- Current, pump 1-6
- Current, pilot pump
- Specific energy

Setting via the operating panel

- Settings > Secondary functions > Go to setting of analog input.
 1. Select analog output and range.
 2. Select: Parameter.
Display 4.3.10.2 appears.
 3. Select output.
 4. Press .
 5. Set: Signal range.

9.7.36 Counter inputs (4.3.11)



Fig. 90 Counter inputs

Description

You can set CU 352 to accumulate a pumped volume from a digital water meter.

Setting via the operating panel

1. Select digital input for volume counter
2. Define unit (unit of volume per digital input pulse).
3. Define scaling of pulse counts.



This menu only appears if an IO351B module is connected to CU 352.

9.7.37 Min., max. and user-defined duty (4.3.14)

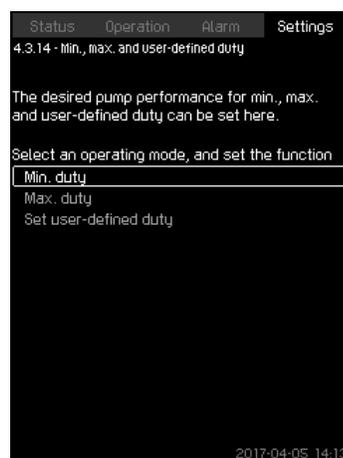

Fig. 91 Min., max. and user-defined duty

Description

This function allows you to let the pumps run in open loop at a set performance.

Setting range

CU 352 allows you to change between three operating modes:

1. [Min. duty \(4.3.14.1\)](#).
2. [Max. duty \(4.3.14.2\)](#).
3. [User-defined duty \(4.3.14.3\)](#).



For each of these operating modes, you can set the number of operating pumps and the pump performance (speed).

9.7.38 Min. duty (4.3.14.1)

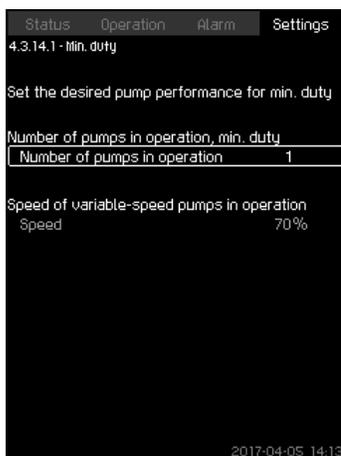

Fig. 92 Min. duty

Description

In all systems, apart from MPC-S systems, minimum duty is only possible for variable-speed pumps. In MPC-S systems, you can only set the number of pumps running at 100 % speed.

Setting range

- Number of pumps in operation.
- Speed as percentage (25 to 100 %) for variable-speed pumps.

Setting via the operating panel

- Settings > Secondary functions > Min., max. and user-defined duty > Min. duty.

Select and set:

- Number of pumps in operation, min. duty.
- Speed.

Factory setting

Number of pumps in operation during min. duty:	1
Speed as percentage for variable-speed pumps:	70

9.7.39 Max. duty (4.3.14.2)

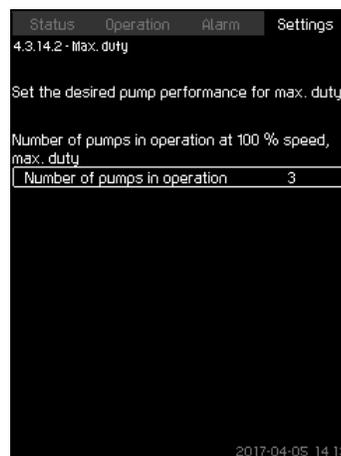

Fig. 93 Max. duty

Description

The function allows you to set a number of pumps to run at maximum performance when the function is enabled.

Setting range

You can set the number of pumps to run in the operating mode "Max.". All pumps run at 100 % speed.

Setting via the operating panel

- Settings > Secondary functions > Min., max. and user-defined duty > Max. duty.

Select and set:

- Number of pumps in operation at 100 % speed, max. duty.

Factory setting

Number of pumps in operation during max. duty:	All pumps (except standby pumps)
--	----------------------------------

9.7.40 User-defined duty (4.3.14.3)

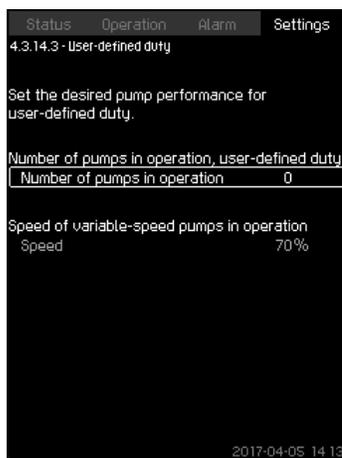

Fig. 94 User-defined duty

Description

You can set a user-defined performance, typically a performance between minimum and maximum duty.

The function allows you to set a pump performance by selecting the number of pumps to run and the speed of variable-speed pumps.

This function primarily selects the variable-speed pumps. If the number of selected pumps exceeds the number of variable-speed pumps, mains-operated pumps are started too.

Setting range

- Number of pumps in operation.
- Speed as percentage for variable-speed pumps.
Note: In systems with only variable-speed pumps, the speed can be set between 25 and 100 %; in systems with both variable-speed pumps and mains-operated pumps the speed can be set between 70 and 100 %.

Setting via the operating panel

- Settings > Secondary functions > Min., max. and user-defined duty > User-defined duty.

Select and set:

- Number of pumps in operation, user-defined duty.
- Speed.

Factory setting

The function is disabled as the following has been set:

Number of pumps in operation during user-defined duty: 0

9.7.41 Pump curve data (4.3.19)

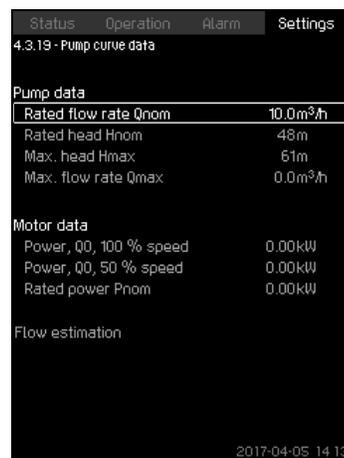

Fig. 95 Pump curve data

Description

CU 352 has a number of functions using these pump data:

- Rated flow rate Q_{nom} [gpm]
- Rated head H_{nom} [ft]
- Max. head H_{max} [ft]
- Max. flow rate Q_{max} [gpm]
- Power, Q_0 , 100 % speed [kW]
- Power, Q_0 , 50 % speed [kW]
- Rated power P_{nom} [kW]



Grundfos can supply hydraulic data for CR, CRI, CRE and CRIE pumps where GSC files can be downloaded to CU 352.

All other pump types require manual entering of hydraulic pump data.



Enter the electrical data, "Power, Q_0 , 100 % speed" and "Power, Q_0 , 50 % speed" manually for all pump types, including CR, CRI, CRE and CRIE.

For Grundfos E-pumps, enter the data of input power (P_1).

The data are read by means of the pump performance curves which can be found in Grundfos Product Center on Grundfos' homepage, www.grundfos.com. See the examples in figures 96 to 99.

If Grundfos Product Center is not accessible, try to bring a pump into the three duty points:

- Power, Q_0 , 100 % speed
- Power, Q_0 , 50 % speed
- Rated power P_{nom} .

Read the power values in displays 1.3 to 1.8, depending on the pump. See section 9.4.10 Pump 1-6, Pilot pump (1.3 - 1.10).

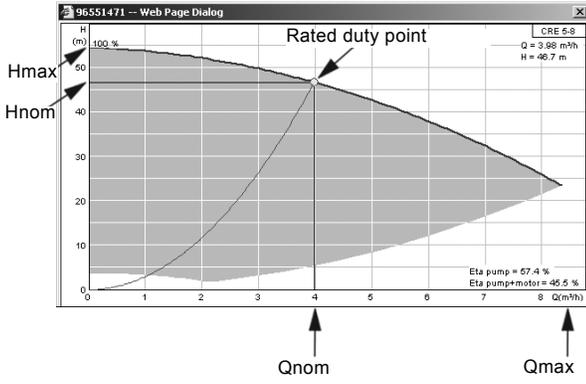

Fig. 96 Reading of Qnom, Hnom, Hmax and Qmax (Grundfos Product Center)

TM03 9993 4807

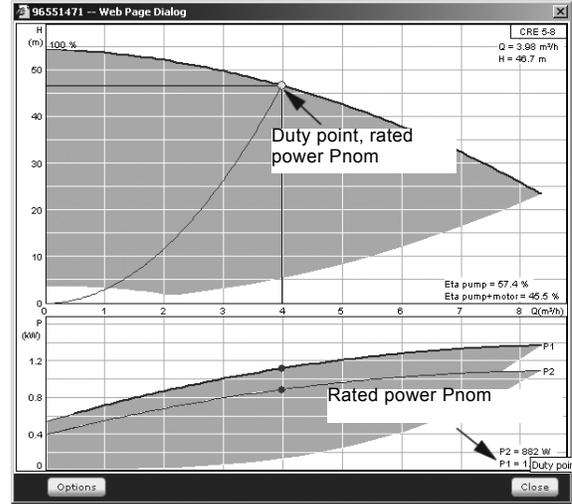

Fig. 99 Reading of rated power Pnom (Grundfos Product Center)

TM03 9996 4807



Qnom and Hnom are the rated duty point of the pumps and usually the duty point with the highest efficiency.

Setting via the operating panel

- Settings > Secondary functions > Pump curve data.
- Select and set:
 - Rated flow rate Qnom
 - Rated head Hnom
 - Max. head Hmax
 - Max. flow rate Qmax
 - Power, Q0, 100 % speed
 - Power, Q0, 50 % speed
 - Rated power Pnom.

TM03 9994 4807

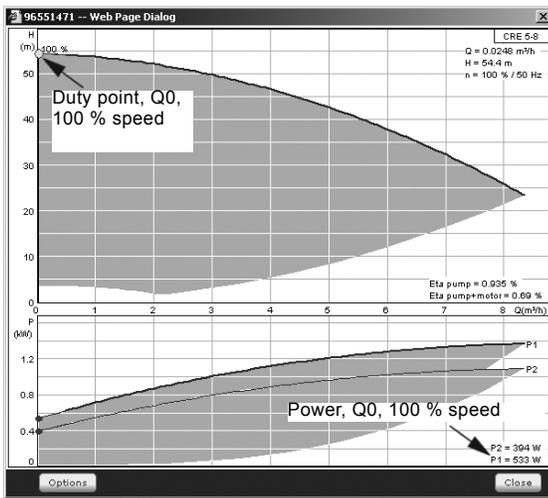

Fig. 97 Reading of power, Q0, 100 % speed (Grundfos Product Center)

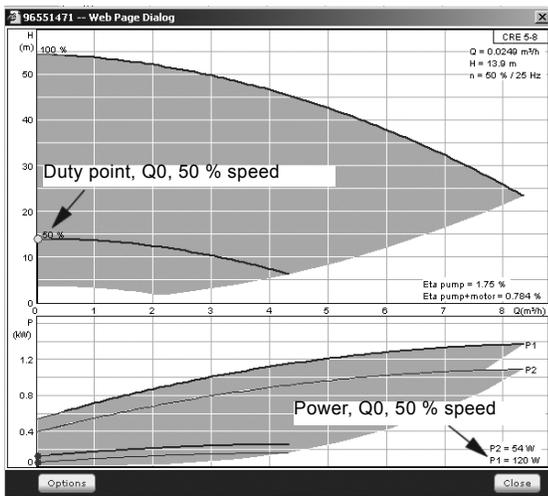

Fig. 98 Reading of power, Q0, 50 % speed (Grundfos Product Center)

TM03 9995 4807

9.7.42 Control source (4.3.20)

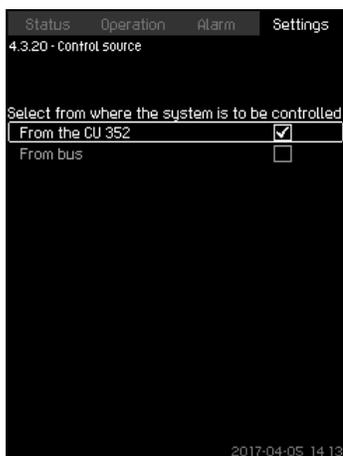

Fig. 100 Control source

Description

The system can be remote-controlled via an external bus connection (option). See section [9.8.2 GENibus](#). For further information, see section [9.8 Data communication](#). Select the control source, that is either CU 352 or the external bus connection.

Setting via the operating panel

- Settings > Secondary functions > Control source.

Factory setting

The control source is CU 352.

9.7.43 Fixed inlet pressure (4.3.22)



Fig. 101 Fixed inlet pressure

Description

This function is only used when no inlet-pressure sensor is fitted in the system and the inlet pressure is fixed and known.

If the pump system has a fixed inlet pressure, you can enter it in this display so that CU 352 can optimize the performance and control of the system.

Setting range

A fixed inlet pressure can be set, and the function can be enabled and disabled.

Setting via the operating panel

- Settings > Secondary functions > Fixed inlet pressure.
- Select: Enabled or Disabled.
- Set: Fixed inlet pressure.

Factory setting

The function is disabled.

9.7.44 Flow estimation (4.3.23)

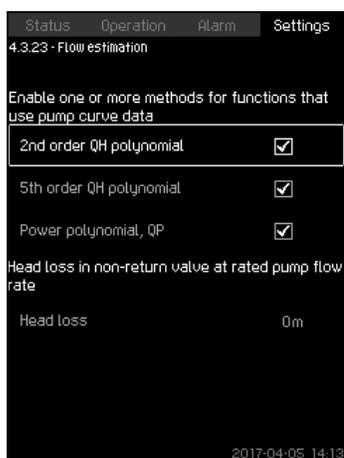

Fig. 102 Flow estimation

Description

As described in section [9.7.41 Pump curve data \(4.3.19\)](#), CU 352 can optimize operation according to performance curves and motor data. In this display, you can select the curve types which CU 352 uses for the optimization if they are available.

At large flow rates, there may be a considerable head loss between the pump outlet flange and the pressure sensor. The loss is caused by non-return valves and pipe bends. To improve the flow estimation of the system, it is necessary to compensate for the difference between the measured and the actual differential pressure across the pump. This is done by entering the head loss in non-return valves and pipe bends at the rated flow rate of one pump.

Setting range

- 2nd order QH polynomial
- 5th order QH polynomial
- Power polynomial, QP
- Head loss



It is possible to select several curve types, as CU 352 makes a priority based on the data available.

Setting via the operating panel

- Settings > Secondary functions > Flow estimation.

Factory setting

All polynomials are selected.

9.7.45 Reduced operation (4.3.24)

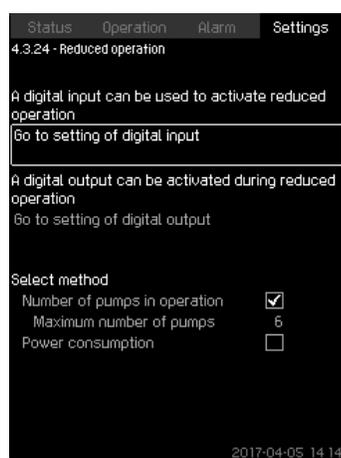

Fig. 103 Reduced operation

Description

This function allows you to limit the number of pumps in operation, or for MPC-E systems, to limit power consumption. The limit is activated by a digital input.

Setting range

- Setting of digital input ([9.7.27 Digital inputs \(4.3.7\)](#)).
- Setting of digital output ([9.7.32 Digital outputs \(4.3.9\)](#)).
- Maximum number of pumps in operation.
- Maximum power consumption.

Setting via the operating panel

- Settings > Secondary functions > Reduced operation.
 1. Select: Go to setting of digital input.
 2. Select digital input.
 3. Select: Reduced operation.
 4. Press **↵** x 2.
 5. Select: Go to setting of digital output.
 6. Select digital output.
 7. Select: Reduced operation.
 8. Press **↵** x 2.
 9. Set: Number of pumps in operation or Power consumption.

Factory setting

No digital input is selected (disabled).

9.7.46 Multisensor settings (4.3.25)

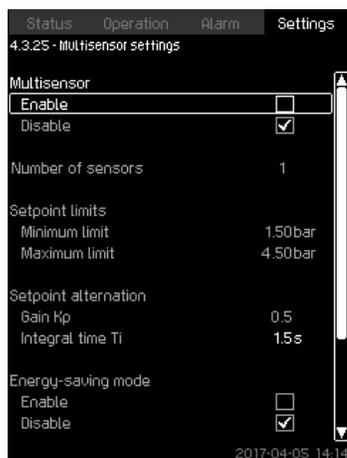

Fig. 104 Multisensor settings

Description

This function is designed for controlling up to six different zones in a HVAC system with a defined differential-pressure band. The function will if one of the "Multisensor" signals are outside the specific sensor limits (minimum/maximum) influence the setpoint (SP) up or down to insure that the specific sensor or zone is kept within its pressure band.

You can adjust the reaction of the setpoint influence by the means of dedicated "Setpoint alternation", Kp and Ti values.

In case more sensors are either under or above their limits, you can set a priority between the sensors. Furthermore, the system can optimize the actual setpoint if "Energy-saving mode" is activated, thus, the system will lower the actual setpoint until the minimum limit for one of the multisensors.

Setting range

- Number of sensors
- Setpoint limits:

The range with the function will operate the control setpoint up or down according to the "Multisensor" feedback.
- Setpoint alternation
 - Gain Kp
 - Integral time Ti
- Energy-saving mode

In this mode, the system ramps down the actual setpoint towards the minimum limit for one of the "Multisensor".
- Control mode
 - Minimum limit:

In this mode, the actual setpoint will be ramped up or down by the remote sensor with the highest priority if the remote sensor is outside its "Minimum limit" or "Maximum limit".
 - Minimum mode:

In this mode, the actual setpoint must be ramped up by the remote sensors if one or more of the remote sensors are below their "Minimum limit".

Settings via the operating panel

- Settings > Secondary functions > Multisensor settings.
 1. Select: Enable.
 2. Set: Number of sensors
 3. Set: Setpoint limits (Select minimum and maximum).
 4. Set: Setpoint alternation (Gain Kp and Integral Ti)
 5. Enable "Energy-saving mode" if requested
 6. Set: Control mode (Select Priority mode or Minimum mode).
 7. Press "Multisensor settings" to set the individual settings for each multisensor.

9.7.47 Multisensor settings (4.3.25.1)



Fig. 105 Multisensor settings

Description

Each "Multisensor" needs to be defined in order for the function to work correctly.

Setting range

- Name
- Sensor limits
- Sensor priority (1-6, High = 1)
- Filter factor [second] (time period where the remote sensor feedback signal is averaged over.)
- Sensor source

Local = AI

Bus = BUS communication

Setting via the operating panel

- Settings > Secondary functions > Multisensor settings > Multisensor settings.

9.7.48 Monitoring functions (4.4)

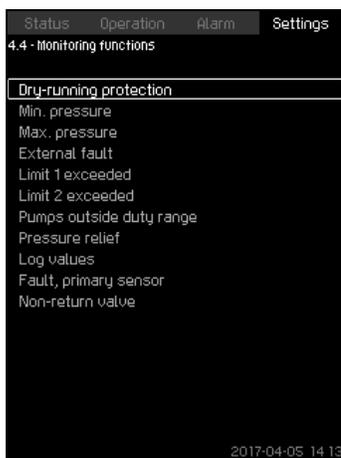

Fig. 106 Monitoring functions

Description

The system has a series of functions that constantly monitor the operation of the system.

The primary purpose of the monitoring functions is to ensure that faults do not damage pumps or the system.

Setting range

- [Dry-running protection \(4.4.1\)](#)
- [Min. pressure \(4.4.2\)](#)
- [Max. pressure \(4.4.3\)](#)
- [External fault \(4.4.4\)](#)
- [Limit 1 exceeded \(4.4.5 - 4.4.6\)](#)
- [Pumps outside duty range \(4.4.7\)](#)
- [Pressure relief \(4.4.8\)](#)
- [Log values \(4.4.9\)](#)
- [Fault, primary sensor \(4.4.10\)](#)

Setting via the operating panel

- Settings > Monitoring functions.

9.7.49 Dry-running protection (4.4.1)

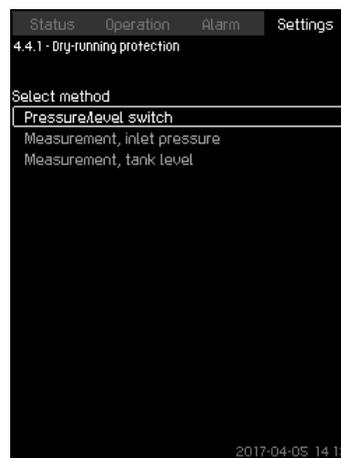

Fig. 107 Dry-running protection

Description

Dry-running protection is one of the most important monitoring functions, as the bearings and the shaft seal may be damaged if the pumps run dry. We thus always recommend that you use dry-running protection.

The function is based on monitoring of the inlet pressure or the level in a possible tank or pit on the inlet side.

Level switches, pressure switches or analog sensors signalling water shortage at a set level can be used.

There are three different methods for detection of water shortage:

- Pressure switch on inlet manifold or float switch/electrode relay in the supply tank. See section [9.7.50 Pressure/level switch \(4.4.1.1\)](#).
- Measurement of inlet pressure in the inlet manifold by means of an analog pressure transmitter. See section [9.7.51 Measurement, inlet pressure \(4.4.1.2\)](#).
- Measurement of level in the supply tank by means of an analog level transmitter. See section [9.7.52 Measurement, tank level \(4.4.1.3\)](#).

Setting via the operating panel

- Settings > Monitoring functions > Dry-running protection > Select method.

9.7.50 Pressure/level switch (4.4.1.1)

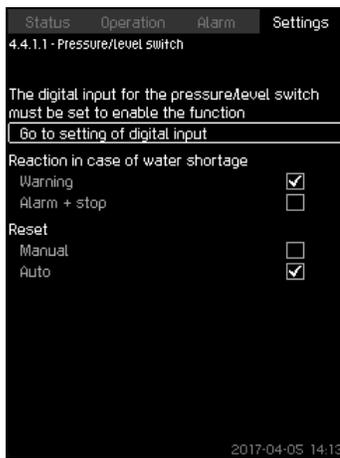

Fig. 108 Pressure/level switch

Description

This function is primarily used in boosting applications. Dry-running protection can take place by means of a pressure switch on the inlet manifold or a level switch in a tank on the inlet side.

When the contact is open, CU 352 registers water shortage after a time delay of approximately five seconds. You can set whether the indication is to be just a warning or an alarm stopping the pumps.

You can set restarting and resetting of alarms to be automatic or manual.

Setting range

- Selection of digital input for the function.
- Reaction in case of water shortage: Alarm + stop.
- Restarting: Manual or Auto.

Setting via the operating panel

- Settings > Monitoring functions > Dry-running protection > Pressure/level switch > Go to setting of digital input. Display [Digital inputs \(4.3.7\)](#) appears.

1. Set the input to dry-running protection.
2. Press ↵.
3. Select:
 - Warning or Alarm + stop.
 - Manual or Auto.

Factory setting

The setting is done in the startup wizard and depends on the application.

9.7.51 Measurement, inlet pressure (4.4.1.2)

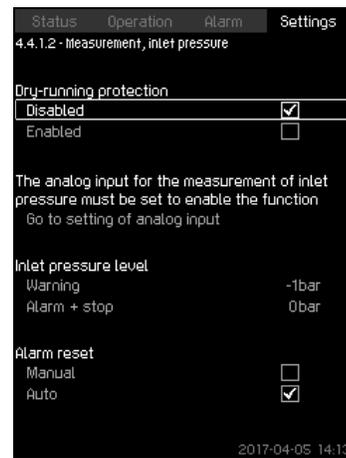

Fig. 109 Measurement, inlet pressure

Description

Dry-running protection can take place by means of a pressure transmitter measuring the inlet pressure.

You can set two levels:

- Warning
- Alarm + stop.

You can set restarting and resetting of alarms to be automatic or manual.

Setting range

- Selection of analog input for the function.
- Inlet pressure level for "Warning".
- Inlet pressure level for "Alarm + stop".
- Restarting: Manual or Auto.

Setting via the operating panel

- Settings > Monitoring functions > Dry-running protection > Measurement, inlet pressure > Go to setting of analog input. Display [Analog inputs \(4.3.8\)](#) appears.

1. Select: Inlet pressure.
2. Press ↵.
3. Select: Enabled.
4. Select and set the level:
 - Warning.
 - Alarm + stop.
5. Select resetting: Auto or Manual.



If one of the levels is not required, the level value must be the minimum value of the inlet-pressure transmitter. This disables the function.

Factory setting

The setting is done in the startup wizard and depends on the application.

9.7.52 Measurement, tank level (4.4.1.3)



Fig. 110 Measurement, tank level

Description

Dry-running protection can take place by means of a level transmitter measuring the level in a tank on the inlet side.

You can set two levels:

- Warning
- Alarm + stop.

You can set restarting and resetting of alarms to be automatic or manual.

Setting range

- Selection of analog input for the function.
- Tank level for "Warning".
- Tank level for "Alarm + stop".
- Restarting: Manual or Auto.

Setting via the operating panel

- Settings > Monitoring functions > Dry-running protection > Measurement, tank level > Go to setting of analog input. Display [Analog inputs \(4.3.8\)](#) appears.

1. Set the input to "Tank level, suction side".
2. Press **↵** x 3.
3. Select: Enabled.
4. Select and set the level:
 - Warning.
 - Alarm + stop.
5. Select alarm resetting: Manual or Auto.

Factory setting

The function is disabled.

9.7.53 Min. pressure (4.4.2)

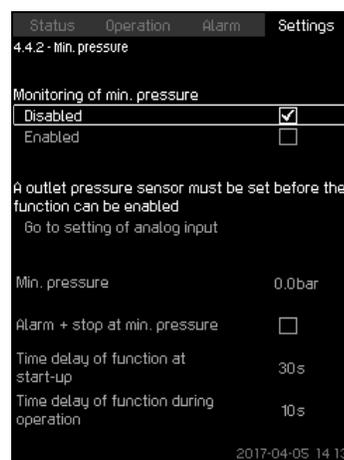

Fig. 111 Min. pressure

Description

The outlet pressure will be monitored if the application is pressure boosting. In all other applications, the system pressure will be monitored. CU 352 will react if the pressure becomes lower than a set minimum level for an adjustable time.

The minimum pressure can be monitored if a fault indication is required in situations where the outlet pressure becomes lower than the set minimum pressure.

You can set whether the indication is to be just a warning or an alarm stopping the pumps. This may be desirable if the system is used for an irrigation system where a very low outlet pressure may be due to pipe fracture and thus an extraordinarily high consumption and a very low counterpressure. In such situations, it is desirable that the system stops and indicates alarm. This situation requires manual resetting of alarms.

You can set a startup delay ensuring that the system can build up pressure before the function is enabled. You can also set a time delay, that is for how many seconds the outlet pressure may be lower than the set minimum pressure before the alarm is activated.

Setting range

- Minimum pressure level within the range of the primary sensor.
- Activation of stop when the pressure falls below the minimum pressure.
- Time delay of function at start-up.
- Time delay of function during operation.

Setting via the operating panel

- Settings > Monitoring functions > Min. pressure > Enabled.
1. Select and set: Min. pressure.
 2. Select: Alarm + stop at min. pressure.
 3. Set:
 - Time delay of function at start-up
 - Time delay of function during operation.

Factory setting

The function is disabled.

9.7.54 Max. pressure (4.4.3)

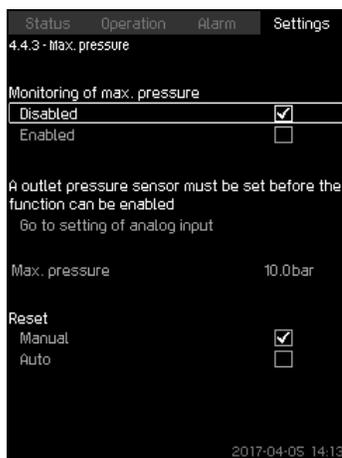

Fig. 112 Max. pressure

Description

The outlet pressure will be monitored if the application is pressure boosting. In all other applications, the system pressure will be monitored. CU 352 will react if the pressure becomes higher than a set maximum level.

In certain installations, a too high outlet pressure may cause damage. It may therefore be necessary to stop all pumps for a short period if the pressure is too high.

You can set whether the system is to restart automatically after the pressure has dropped below the maximum level, or if the system must be reset manually. Restarting will be delayed by an adjustable time. See section [9.7.14 Min. time between start/stop \(4.2.1\)](#).

Setting range

- Maximum pressure level within the range of the primary sensor.
- Manual or automatic restarting.

Setting via the operating panel

- Settings > Monitoring functions > Max. pressure > Enabled.
- 4. Set: Max. pressure.
- 5. Select resetting: Manual or Auto.

Factory setting

The function is disabled.

9.7.55 External fault (4.4.4)

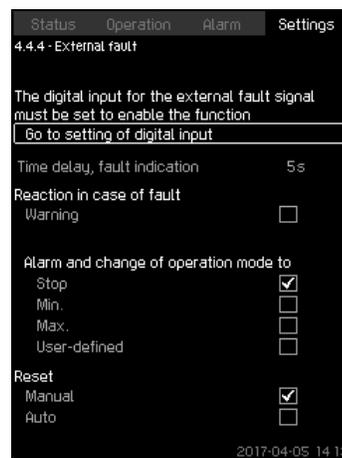

Fig. 113 External fault

Description

The function is used when CU 352 is to be able to receive a fault signal from an external contact. In case of external fault, CU 352 indicates warning or alarm. In case of alarm, the system changes to another manual operating mode, for instance "Stop".

Setting range

- Selection of digital input for the function.
- Setting of time delay from closing of the contact until CU 352 reacts.
- Reaction in case of external fault: Warning or alarm and change of operating mode.
- Restarting after alarm: Manual or Auto.

Setting via the operating panel

- Settings > Monitoring functions > External fault > Go to setting of digital input. Display [Digital inputs \(4.3.7\)](#) appears.
- 6. Set the input to "External fault".
- 7. Press \leftarrow .
- 8. Set: Time delay, fault indication.
- 9. If only a warning is required in case of external fault, select "Warning".
If the system is to give alarm and change operating mode in case of external fault, select operating mode "Manual" or "Auto".

Factory setting

The function is disabled. If the function is enabled, the following values have been set from factory:

- Time delay: 5 seconds.
- Operating mode in case of alarm: Stop.
- Restarting: Manual.

9.7.56 Limit 1 exceeded (4.4.5 - 4.4.6)

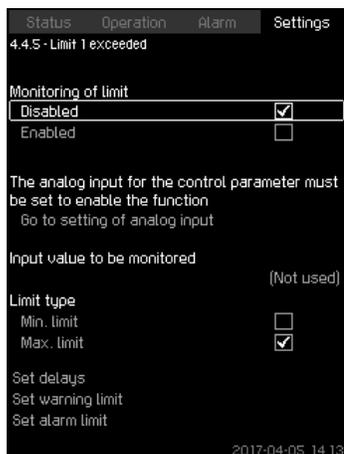

Fig. 114 Limit 1 exceeded

Description

With this function, CU 352 can monitor set limits of analog values. It will react if the values exceed the limits. Each limit can be set as a maximum or minimum value. For each of the monitored values, a warning limit and an alarm limit must be defined.

The function allows you to monitor two different locations in a pump system at the same time, for instance the pressure at a consumer and the pump's outlet pressure. This ensures that the outlet pressure does not reach a critical value.

If the value exceeds the warning limit, a warning is given. If the value exceeds the alarm limit, the pumps will be stopped.

You can set a delay between the detection of an exceeded limit and the activation of a warning or an alarm. You can also set a delay for resetting a warning or an alarm.

A warning can be reset automatically or manually.

You can set whether the system is to restart automatically after an alarm, or if the alarm must be reset manually. Restarting can be delayed by an adjustable time. You can also set a startup delay ensuring that the system reaches a steady state before the function becomes active.

Setting range

- Selection of analog input for the function
- Input value to be monitored
- Limit type (Min. limit and Max. limit)
- warning limit
- alarm limit.

Setting via the operating panel



Analog inputs must be correctly set before the function is enabled. See section [9.7.29 Analog inputs \(4.3.8\)](#).

- Settings > Monitoring functions > Limit 1 exceeded / Limit 2 exceeded > Go to setting of analog input.
 1. Select analog input.
 2. Select: Input value to be monitored. Display 4.3.8.1.1 appears.
 3. Select input.
 4. Press \leftarrow .
 5. Set the minimum and maximum sensor value.
 6. Press \leftarrow x 2.
 7. Select: Input value to be monitored.
 8. Select input.
 9. Press \leftarrow .
 10. Select:
 - Min. limit or Max. limit.
 - Set delays.
 11. Press \leftarrow .
 12. Select:
 - Set warning limit
 - Enabled.
 13. Set limit.
 14. Select resetting: Manual or Auto.
 15. Press \leftarrow .
 16. Select:
 - Set alarm limit
 - Enabled.
 17. Set limit.
 18. Select resetting: Manual or Auto.
 19. Press \leftarrow .
 20. Select: Enabled.

Factory setting

The function is disabled.

9.7.57 Pumps outside duty range (4.4.7)

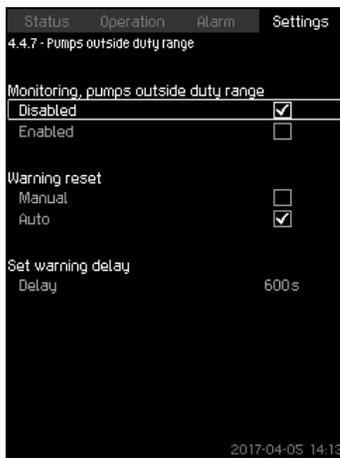

Fig. 115 Pumps outside duty range

Description

The function gives a warning if the duty point of the pumps moves outside the defined range. For instance, if the inlet pressure becomes lower than a minimum permissible value, thus causing a risk of cavitation for some pump types.

The warning is given with a set time delay. You can set whether the warning is to be reset automatically or manually when the duty point comes within the defined duty range. You can also set a relay output to be activated when the warning is given, and to be deactivated when the warning is reset.

This function requires that the outlet pressure and the inlet pressure (either measured or configured) or the differential pressure of the pumps is monitored, and that CU 352 contains valid pump data from either a GSC file or from manual input. See section [9.7.41 Pump curve data \(4.3.19\)](#).

Setting range

- Setting of manual or automatic resetting.
- Setting of warning delay.

Setting via the operating panel

- Settings > Monitoring functions > Pumps outside duty range > Manual / Auto > Set warning delay.

Factory setting

The function is disabled.

9.7.58 Pressure relief (4.4.8)



Fig. 116 Pressure relief

Description

The purpose of the function is to reduce the pressure in the pipes by opening a solenoid valve if it exceeds a set limit. If the pressure is not reduced within a given time, the solenoid valve will be closed, and a warning can be given.

- 1: Solenoid valve opens.
- 2: Solenoid valve closes.
- 3: Solenoid valve opens.
- 4: Warning is activated.
- 5: Solenoid valve closes, and warning is reset.

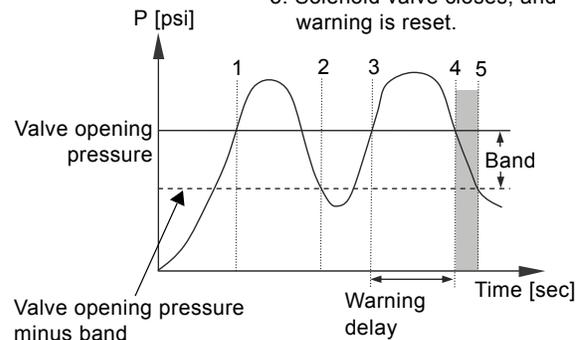

Fig. 117 Pressure relief

Setting range

- Setting of digital output.
- Setting of pressure to be monitored.
- Setting of valve opening pressure.
- Setting of band for valve opening pressure.
- Setting of warning or alarm.

Setting via the operating panel

- Settings > Monitoring functions > Pressure relief > Go to setting of digital output.
1. Select digital output.
 2. Select: Pressure relief valve.
 3. Press \leftarrow x 2.
 4. Select: Pressure to be monitored
 - Select: Outlet pressure, System pressure or External pressure.
 5. Press \leftarrow .
 6. Select and set:
 - Valve opening pressure
 - Band, valve opening pressure.
 7. Select: Warning > Disabled or Enabled.
 8. Set: Delay. (Only to be set if warning has been enabled).
 9. Select: Enabled.

Factory setting

The function is disabled.

9.7.59 Log values (4.4.9)

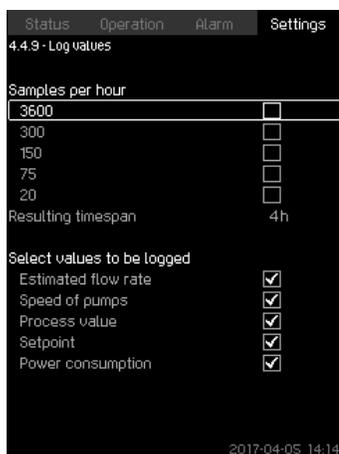

Fig. 118 Log values

Description

Select the values to be logged and the number of samples per hour. The resulting timespan is shown. When the timespan has elapsed, old logged values will be deleted and overwritten by the new ones.

Log values

- Estimated flow rate (only if no flowmeter is installed)
- Speed of pumps
- Process value
- Setpoint
- Power consumption (MPC-E systems)
- Inlet pressure (if an inlet-pressure sensor is installed).

Setting range

Samples per hour: 1-3600.

Setting via the operating panel

- Settings > Monitoring functions > Log values.
1. Set: Samples per hour.
 2. Select the values to be logged.

9.7.60 Fault, primary sensor (4.4.10)

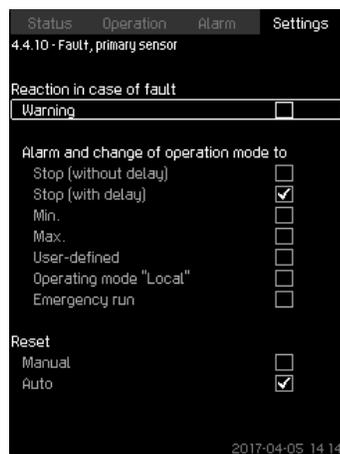

Fig. 119 Fault, primary sensor

Description

You can set how the system is to react if the primary sensor fails.

Setting range

- Stop (without delay)
- Stop (with delay)
- Min.
- Max.
- User-defined
- Operating mode "Local"
- Emergency run
- Reset: Manual or Auto.

Setting via the operating panel

- Settings > Monitoring functions > Fault, primary sensor.
1. Select reaction in case of a fault in the primary sensor.
 2. Select resetting: Manual or Auto.

9.7.61 Non-return valve (4.4.11)

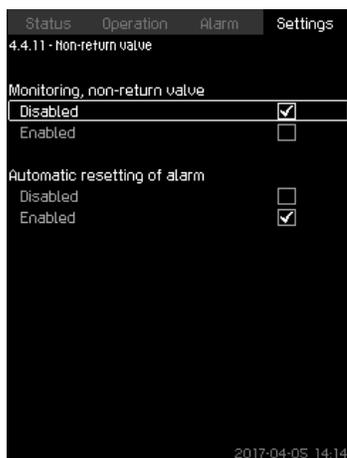

Fig. 120 Non-return valve

Description

This function enables CU 352 to detect if a "Non-return valve" is leaking or faulty. A small leakage will after five accumulated incidents result in a warning. A faulty NRV will instantly result in an alarm and pump stop. In this case the motor is not able to overcome the backflow through the pump with the faulty NRV.



The function is only valid for a MPC-E system with MLE motors model G, H, I or J.

Setting range

- Monitoring, non-return valve: Enabled or Disabled.
- Automatic resetting of alarm: Enabled or Disabled.

Setting via the operating panel

- Settings > Monitoring functions > Non-return valve
1. Enable the function.
 2. Select if "Automatic resetting of alarm" is to be "Disabled".

Factory setting

The function is "Enabled".

9.7.62 Functions, CU 352 (4.5)



Fig. 121 Functions, CU 352

Description

Make the basic settings of CU 352 in this submenu.

CU 352 comes with most of these settings, or they are made at startup and normally not to be changed.

The service language, English, can be selected for service purposes. If no buttons are touched for 15 minutes, the display returns to the language selected at startup or to the language set in [Display language \(4.5.1\)](#).



If the service language is selected, the symbol ↗ is to the right in the top line of all displays.

Setting range

- Activation of service language, British English.
- Re-activation of startup wizard. (After startup, the wizard is inactive.)
- Selection of "Display language".
- Selection of display units.
- Setting of "Date and time".
- Selection of password for menu "Operation" and "Settings".
- Setting of "Ethernet" communication.
- Setting of "GENIbus number".
- Reading of "Software status".

9.7.63 Display language (4.5.1)



Fig. 122 Display language

Description

Here you select the language for the CU 352 display.

Setting range

- English
- German
- Danish
- Spanish
- Finnish
- French
- Greek
- Italian
- Dutch
- Polish
- Portuguese
- Russian
- Swedish
- Chinese
- Korean
- Japanese
- Czech
- Turkish
- Hungarian
- Bulgarian
- Croatian
- Latvian
- Lithuanian
- Romania
- Slovak
- Slovenian
- Serbian Latin
- US English
- Indonesian
- Malay
- Estonian.

Setting via the operating panel

- Settings > Functions, CU 352 > Display language.

Factory setting

The display language is English. It can be changed at startup.

9.7.64 Units (4.5.2)

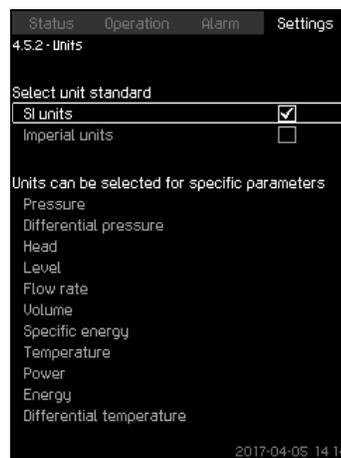

Fig. 123 Units

Description

Here you can select units for the various parameters.

Select between SI and imperial units. You can also select other units for the individual parameters.

Setting range

Parameter	Basic setting		Possible units
	SI	Imperial	
Pressure	bar	psi	kPa, MPa, mbar, bar, m, psi
Differential pressure	m	psi	kPa, MPa, mbar, bar, m, psi
Head	m	ft	m, cm, ft, in
Level	m	ft	m, cm, ft, in
Flow rate	m ³ /h	gpm	m ³ /s, m ³ /h, l/s, gpm, yd ³ /s, yd ³ /min, yd ³ /h
Volume	m ³	gal	l, m ³ , gal, yd ³
Specific energy	kWh/m ³	Wh/gal	kWh/m ³ , Wh/gal, Wh/kgal, BTU/gal, HPh/gal
Temperature	°C	°F	K, °C, °F
Differential temperature	K	K	K
Power	kW	HP	W, kW, MW, HP
Energy	kWh	kWh	kWh, MWh, BTU, HPh



If units are changed from SI to imperial or vice versa, all individually set parameters will be changed to the basic setting in question.

Setting via the operating panel

- Settings > Functions, CU 352 > Units.

Set unit standard, measuring parameter and specific unit. See the example in fig. 124.

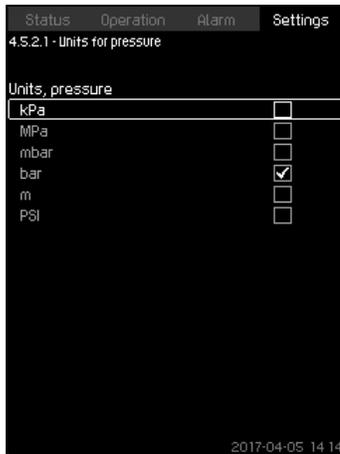

Fig. 124 Example of selection of units

Factory setting

The setting is done in the startup wizard and depends on the application.

9.7.65 Date and time (4.5.3)

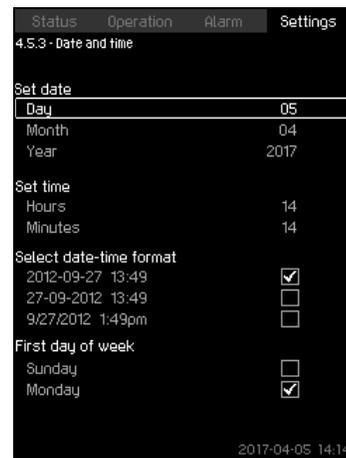

Fig. 125 Date and time

Description

You can set date and time as well as how they are to be shown in the display.

The clock has a built-in rechargeable voltage supply which can supply the clock for up to 20 days if the voltage supply to the system is interrupted.

If the clock is without voltage for more than 20 days, it must be set again.

Setting range

The date can be set as day, month and year. The time can be set as a 24-hour clock showing hours and minutes.

There are three formats.

Examples of format

2012-09-27 13:49

27-09-2012 13:49

9/27/2012 1:49 pm

You can also select if Sunday or Monday is to be the first day of week.

Setting via the operating panel

- Settings > Functions, CU 352 > Date and time.
1. Select and set:
 - Day, Month, Year, Hours, Minutes.
 2. Select format.
 3. Select "Sunday" or "Monday" under "First day of week".

Factory setting

Local time.



If the system has been without voltage for more than 20 days since it left the factory, the clock may have returned to the original setting: 01-01-2005 0:00.

Date and time may have been changed during the setting of system.

There is no automatic changeover to/from daylight-saving time.

9.7.66 Password (4.5.4)

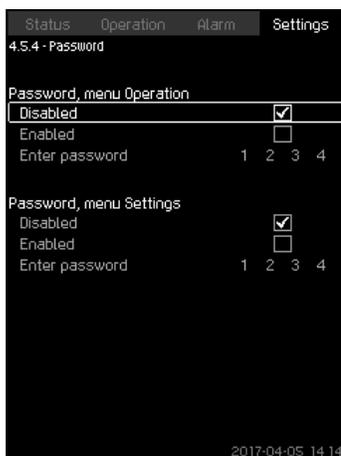

Fig. 126 Password

Description

You can limit the access to the menus "Operation" and "Settings" by means of a password. If the access is limited, it is not possible to view or set any parameters in the menus.

The password must consist of four digits and may be used for both menus.



If you have forgotten the password(s), contact Grundfos.

Setting via the operating panel

- Settings > Functions, CU 352 > Password.
1. Select the password to be enabled.
 2. Select: Enter password.
The first digit of the password is flashing.
 3. Select digit.
The second digit of the password is flashing.
 4. Repeat these steps if it is necessary to enable the other password.

Factory setting

Both passwords are disabled. If a password is enabled, the factory setting will be "1234".

9.7.67 Ethernet (4.5.5)

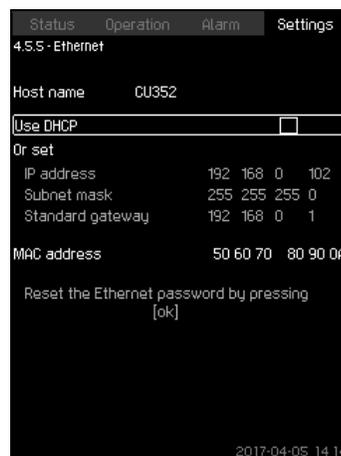

Fig. 127 Ethernet

Description

CU 352 is equipped with an Ethernet connection for communication with a computer, either direct or via Internet. See also section [9.8.1 Ethernet](#).

9.7.68 GENIbus number (4.5.6)

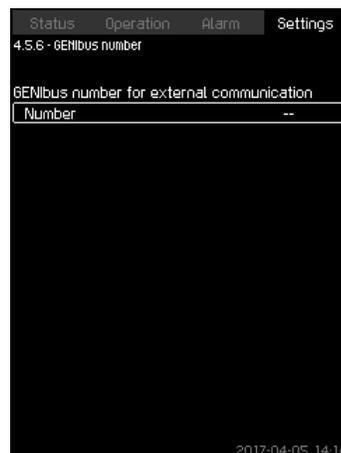

Fig. 128 GENIbus number

Description

CU 352 can communicate with external units via an RS-485 interface (option). For further information, see fig. [132](#) and section [7](#). [Click \[Apply\]](#).

Communication is carried out according to the Grundfos bus protocol, GENIbus, and enables connection to a building management system or another external control system.

Operating parameters, such as setpoint and operating mode, can be set via the bus signal. Furthermore, status about important parameters, such as actual value and input power, and fault indications can be read from CU 352.

Contact Grundfos for further information.

Setting range

The number can be set between 1 and 64.

Setting via the operating panel

- Settings > Functions, CU 352 > GENIbus number.

Factory setting

No number has been set.

9.7.69 Software status (4.5.9)

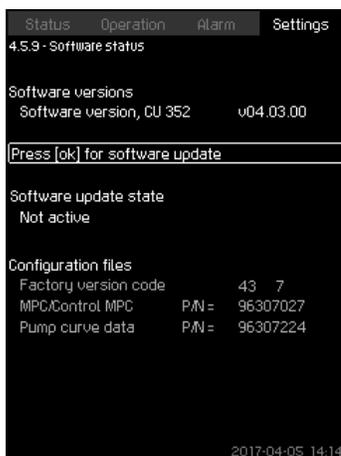

Fig. 129 Software status

Description

This display shows the status of the software installed in CU 352. Furthermore, the version code and the product numbers of configuration files (GSC) read into the unit are shown. You can also upgrade the software version. Contact Grundfos for further information.

9.7.70 Status display menu (4.6)

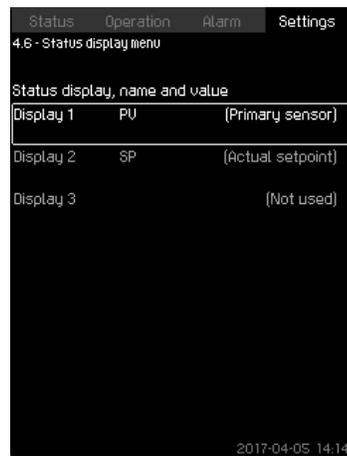

Fig. 130 Status display menu

Description

In the main status menu, you can have up to three status values displayed.

In this menu, you can define each status value to be displayed and define a short name for the value.

PV = Process Value

SP = Setpoint

Q = Flow

Setting range

Name of each display value

Function type for Display 1-3

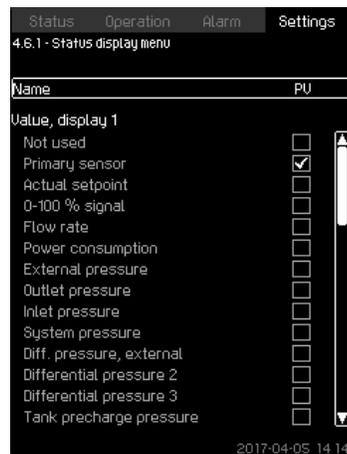

Fig. 131 Status display menu (4.6.1)

Setting in operating panel

- Settings > Status display menu
- 1. Select display 1, 2 or 3, press [OK].
- 2. Define a name for display.
- 3. Select the value for the display 1, 2 or 3.

Factory settings

Display 1: PV, Primary sensor

Display 2: SP, Actual setpoint

9.8 Data communication

CU 352 is equipped with a hardware enabling communication with external units, such as a computer, via an external GENIbus or ethernet connection.

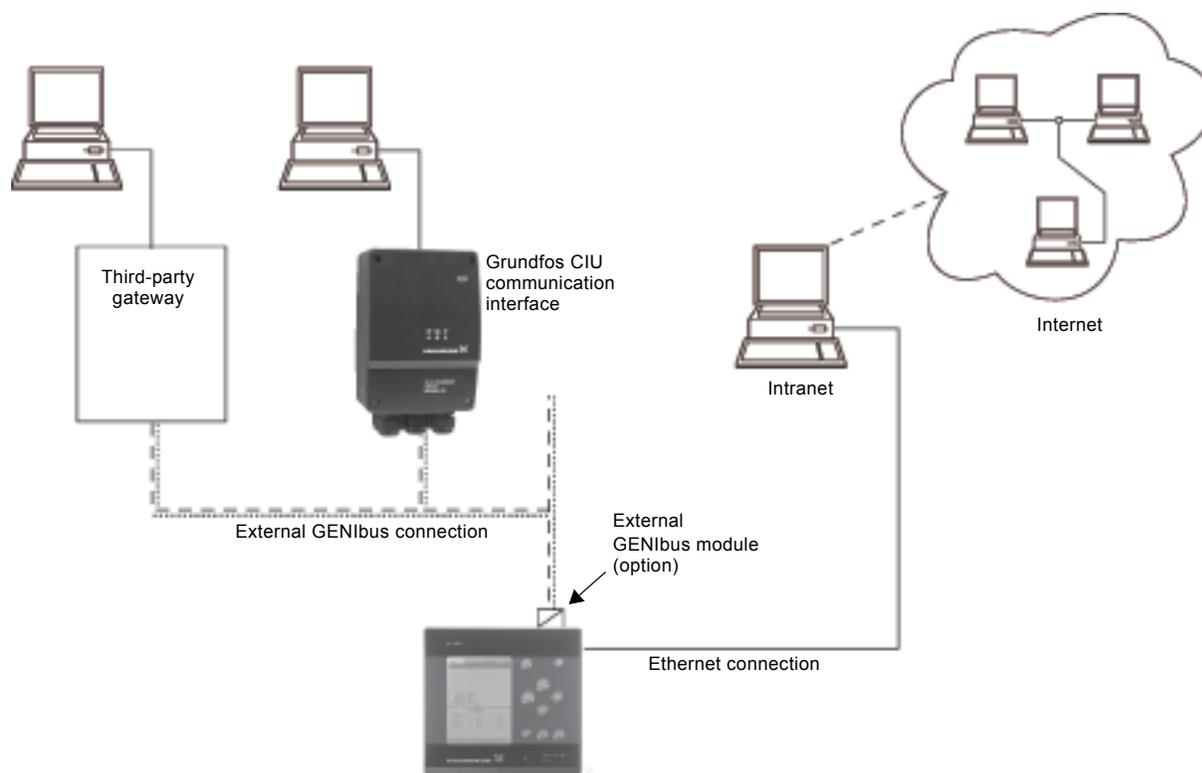

Fig. 132 Data communication via external GENIbus and ethernet connection

9.8.1 Ethernet

Ethernet is the most widely used standard for local networks (LAN). The standardization of this technology has created some of the easiest and cheapest ways of creating communication between electric units, for instance between computers or between computers and control units.

The webserver of CU 352 makes it possible to connect a computer to CU 352 via an ethernet connection. The user interface can thus be exported from CU 352 to a computer so that CU 352 and consequently the system can be monitored and controlled externally.



We recommend that you protect the connection to CU 352 according to your safety requirements in consultation with the system administrator.

In order to use the webserver, you must know the IP address of CU 352. All network units must have a unique IP address to communicate with each other. The IP address of CU 352 from factory is 192.168.0.102.

Alternatively to the factory-set IP address, it is possible to use a dynamic assignment of IP address. This is possible by activating a DHCP (Dynamic Host Configuration Protocol) in CU 352 or via the webserver. See the example in fig. 133.

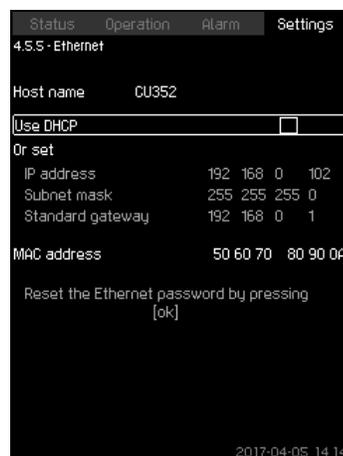

Fig. 133 Example of setting of Ethernet

Dynamic assignment of an IP address for CU 352 requires a DHCP server in the network. The DHCP server assigns a number of IP addresses to the electric units and makes sure that two units do not receive the same IP address.

A standard internet browser is used for connection to the webserver of CU 352.

If you want to use the factory-set IP address, no changes are required in the display. Open the internet browser and enter the IP address of CU 352.

If you want to use dynamic assignment, you must enable the function by selecting "Use DHCP" and clicking [ok]. A check mark shows that the function has been enabled.

Open the internet browser and enter the host name of CU 352 instead of the IP address. The internet browser will now try to connect to CU 352. The host name can be read in the display, but can only be changed by either a GSC file (configuration file) or via a webserver. See section *Change of network setting* on page 72.



A host name is required to use DHCP.

This is the first display shown when connecting to CU 352.



Fig. 134 Connection to CU 352

Factory setting

User name: admin
 Password: admin

When you have entered the user name and password, an application starts up in CU 352, provided that a Java Applet has been installed on the computer. If this is not the case, but the computer is connected to the internet, then use the link on the screen to download and install the Java Applet.

The application on CU 352 exports the Java Applet to your browser and gives you access to user interfaces such as display and operating panel.

The Java Applet installation in the browser must be accepted by the user. You can now monitor and control CU 352 from a computer.



Fig. 135 Network setting

Change of network setting

When connection to the webserver of CU 352 has been established, you can change the network setting.



Fig. 136 Change of network setting

1. Click [> Network admin].
2. Enter the changes.
3. Click [Submit] enable the changes.

TM03 2048 0517

TM05 3236 0517

TM03 2050 3505

Administrator configuration



TM03 2051 0517

Fig. 137 Change of user name and password

1. Click [Admin config].
2. Enter new user name if applicable.
3. Click [Apply].
4. Enter existing password.
5. Enter new password.
6. Repeat new password.
7. Click [Apply].

9.8.2 GENIbus

By installing a GENIbus module in CU 352, you can connect the system to an external network. The connection can take place via a GENIbus-based network or a network based on another fieldbus protocol via a gateway. See examples in fig. 132. For further information, contact Grundfos.

The gateway may be a Grundfos CIU communication interface or a third-party gateway. For further information on CIU, see Grundfos Product Center, or contact Grundfos.

10. Servicing the product

WARNING

Electric shock



- Death or serious personal injury
- Switch off the power supply before you start any work on the product.
 - Lock the main switch with a padlock to ensure that the power supply cannot be accidentally switched on.

10.1 Maintaining the product

10.1.1 Pumps

Pump bearings and shaft seal are maintenance-free.

10.1.2 CU 352

CU 352 is maintenance-free. Keep the unit clean and dry, and protect it against direct sunlight. For ambient temperature, see section 14. [Technical data](#).

10.1.3 Motor bearings

Motors without lubricating nipples are maintenance-free.

Lubricate motors with lubricating nipples with a high-temperature lithium-based grease. See the instructions on the fan cover of Grundfos motors.

In the case of seasonal operation where the motor is idle for more than six months of the year, we recommend that you grease the motor when you take the pump out of operation.

11. Protecting the product against frost

If pumps are not used during periods of frost, they must be drained to avoid damage.

Follow these instructions:

1. Loosen the vent screw in the pump head.
2. Remove the drain plug from the base.

WARNING



Electric shock

- Death or serious personal injury
- Make sure that the escaping hot or cold liquid does not cause injury to persons or damage to the equipment.

Do not tighten the vent screw and fit the drain plug until the pump is to be used again.

12. Taking the product out of operation

Switch off the main switch to take the pump system out of operation.

WARNING

Electric shock



- Death or serious personal injury
- Do not touch the conductors in front of the main switch as they are still energized.
 - Lock the main switch with a padlock to ensure that the power supply cannot be accidentally switched on.

Take individual pumps out of operation by switching off the corresponding motor-protective circuit breaker, automatic circuit breaker or fuse.

13. Fault finding

WARNING



Electric shock

Death or serious personal injury

- Switch off the power supply for at least five minutes before you start any work on the product.
- Make sure that the power supply cannot be accidentally switched on.

Fault	Possible cause	Remedy
1. The pumps are not running.	a) The actual pressure is higher than or equal to the setpoint.	Wait until the pressure has dropped, or lower the pressure on the outlet side of the pump system. Check that the pumps start.
	b) The power supply has been switched off.	Connect the power supply.
	c) The main switch has cut out.	Cut in the main switch.
	d) The main switch is defective.	Replace the main switch.
	e) The motor protection has been activated.	Contact Grundfos.
	f) The motor is defective.	Repair or replace the motor.
	g) The pressure transmitter is defective.	Replace the pressure transmitter. Transmitters with 0-20 mA or 4-20 mA output signals are monitored by the pump system.
	h) The cable is broken or short-circuited.	Repair or replace the cable.
2. The pumps start, but stop immediately. The operating pressure is not reached.	a) Water shortage or no inlet pressure.	Re-establish the supply of water to the pump system. When the inlet pressure has been re-established, the pumps will restart after 15 seconds.
3. The pump system has stopped and cannot restart.	a) The pressure transmitter is defective.	Replace the pressure transmitter. Transmitters with 0-20 mA or 4-20 mA output signals are monitored by the pump system.
	b) The cable is broken or short-circuited.	Repair or replace the cable.
	c) The power supply to CU 352 has been switched off.	Connect the power supply.
	d) CU 352 is defective.	Contact Grundfos.
4. Unstable water supply from the pump system.	a) The inlet pressure is too low.	Check the inlet pipe and the inlet strainer, if any.
	b) The inlet pipe, strainer or pumps are partly blocked by impurities.	Clean the inlet pipe, strainer or pumps.
	c) The pumps suck air.	Check the inlet pipe for leakages.
	d) The pressure transmitter is defective.	Replace the pressure transmitter.
5. The pumps are running, but deliver no water.	a) The valves are closed.	Open the valves.
	b) The inlet pipe or pumps are blocked by impurities.	Clean the inlet pipe or pumps.
	c) The non-return valve is blocked in the closed position.	Clean the non-return valve. Check that the non-return valve moves freely.
	d) The inlet pipe is leaky.	Check the inlet pipe for leakages.
	e) There is air in the inlet pipe or pumps.	Vent and prime the pumps. Check the inlet pipe for leakages.
6. The pump system is unable to reach the setpoint.	a) The consumption is too high.	<ul style="list-style-type: none"> • Reduce the consumption, if possible. • Install a bigger pump system.
	b) Too many standby pumps have been selected.	Reduce the number of standby pumps.
	c) There is a pipe fracture or a leakage in the system.	Check the system, and repair the damaged parts, if necessary.
7. Leakage from the shaft seal.	a) The shaft seal is defective.	Replace the shaft seal.
	b) The height adjustment of the pump shaft is inaccurate.	Readjust the shaft height.
8. Noise.	a) The pumps are cavitating.	Clean the inlet pipe or pumps and possibly the inlet strainer.
	b) The pumps do not rotate freely (frictional resistance) due to inaccurate height adjustment of the pump shaft.	Readjust the shaft height.
9. Very frequent starts and stops.	a) The diaphragm tank precharge pressure is not correct.	Set the correct precharge pressure.

14. Technical data

14.1 Pressure

Inlet pressure

The Hydro MPC pump systems can operate with a positive inlet pressure (precharged pressure system) or with a negative inlet pressure (vacuum at the inlet manifold).

We recommend that you calculate the inlet pressure in these cases:

- Water is drawn through long pipes.
- Water is drawn from depths.
- Inlet conditions are poor.



In this document, the term "inlet pressure" is defined as the pressure or vacuum which can be measured immediately before the pump system.

To avoid cavitation, make sure that there is a minimum inlet pressure on the inlet side of the pump system. The minimum inlet pressure in bar can be calculated as follows:

$$H = P_b - \text{NPSH} - H_f - H_v - H_s$$

P_b = Barometric pressure in feet (33.9 feet at sea level). In closed systems, P_b indicates system pressure in feet.

NPSH = **Net Positive Suction Head** in feet. NPSH can be read from the NPSH curve at the maximum capacity at which the pump will run. See the installation and operating instructions for CR, CRI, CRN.

H_f = Friction loss in inlet piping in feet at the highest flow the pump will be delivering.

H_v = Vapor pressure in feet.

H_s = Safety margin of minimum 2 ft head.

$$P \text{ (psi)} = H/2.31$$



If "H" is positive, the pump can operate at a suction lift of maximum "H" feet. If "H" is negative, an inlet pressure (psia) of minimum "H" feet is required.

Maximum inlet pressure

See the CR, CRI, CRN installation and operating instructions (96462123) delivered together with this pump system.

Operating pressure

As standard, the maximum operating pressure is 232 psi (16 bar) for Hydro MPC CR(E) and is 145 psi (10 bar) for Hydro MPC CME.

On request, Grundfos offers Hydro MPC pump systems with a maximum operating pressure higher than 16 bar.

14.2 Temperatures

Liquid temperature:

- for systems with CR(E) 3, CR(E) 5, CME 3 and CME 5 pump models 32 to 140 °F (0 to 60 °C).
- for all other pump models 32 to 180 °F (0-82 °C).

Ambient temperature: 0 to 104 °F (0 to 40 °C).

14.3 Relative humidity

Maximum: 95 %.

14.4 Sound pressure level

See the installation and operating instructions for the CR pumps.

The sound pressure level for a number of pumps can be calculated as follows:

$$L_{\text{max}} = L_{\text{pump}} + (n - 1) \times 3$$

L_{max} = Maximum sound pressure level

L_{pump} = Sound pressure level for one pump

n = Number of pumps

14.5 Electrical data

Supply voltage

See the nameplate.

Backup fuse

See the wiring diagram supplied with the system.

Digital inputs

Open-circuit voltage	24 VDC
Closed-circuit current	5 mA, DC
Frequency range	0-4 Hz



All digital inputs are supplied with PELV voltage (Protective Extra-Low Voltage).

Analog inputs

Input current and voltage	0-20 mA 4-20 mA 0-10 V
Tolerance	± 3.3 % of full scale
Repetitive accuracy	± 1 % of full scale
Input resistance, current	< 250 Ω
Input resistance, voltage, CU 352	50 kΩ ± 10 %
Input resistance, voltage, IO 351	> 50 kΩ ± 10 %
Supply to sensor	24 V, maximum 50 mA, short-circuit protected



All analog inputs are supplied with PELV voltage (Protective Extra-Low Voltage).

Digital outputs (relay outputs)

Maximum contact load	240 VAC, 2 A
Minimum contact load	5 VDC, 10 mA

All digital outputs are potential-free relay contacts.



Some outputs have a common C terminal. For further information, see the wiring diagram supplied with the pump system.

Inputs for PTC sensor or thermal switch

For PTC sensors to DIN 44082. Thermal switches can also be connected.

Open-circuit voltage	12 VDC \pm 15 %
Closed-circuit current	2.6 mA, DC



Inputs for PTC sensors are electrically separated from the other inputs and outputs of the pump system.

15. Related documents

You find further product information about the pump system in the following documents.

All documents are available in Grundfos Product Center:
www.grundfos.com > International website > Grundfos Product Center.

Title	Frequency [Hz]	Publication number
Data booklets		
Grundfos Hydro MPC CME	60	99537904
Installation and operating instructions		
CR, CRI, CRN	50/60	98419736
CRE, CRIE, CRNE, CRKE, SPKE, MTRE, CHIE*	60	98566351
Frequency converter**	50/60	-
Diaphragm tank	-	98817081
Service documentation		
Service instructions	50/60	96646712
Service kit catalogue	50/60	96488862
Other documentation		
***	-	-

* The instructions are only relevant for Hydro MPC-E, S pump systems.

** The instructions are only relevant for Hydro MPC pump systems with external frequency converter.

*** A wiring diagram is supplied with the pump system.

16. Disposing of the product

This product or parts of it must be disposed of in an environmentally sound way:

1. Use the public or private waste collection service.
2. If this is not possible, contact the nearest Grundfos company or service workshop.

GRUNDFOS Kansas City

9300 Loiret Blvd.
Lenexa, Kansas 66219
Phone: (913) 227-3400
Fax: (913) 227-3500

www.grundfos.us

GRUNDFOS Canada

2941 Brighton Road
Oakville, Ontario L6H 6C9 Canada
Phone: +1-905 829 9533
Telefax: +1-905 829 9512

www.grundfos.ca

GRUNDFOS México

Boulevard TLC No. 15
Parque Industrial Stiva Aeropuerto
C.P. 66600 Apodaca, N.L. México
Phone: 011-52-81-8144 4000
Fax: 011-52-81-8144 4010

www.grundfos.mx

L-BPQ-TL-01

99320238 0619

ECM: 1263661

Trademarks displayed in this material, including but not limited to Grundfos, the Grundfos logo and "be think innovate" are registered trademarks owned by The Grundfos Group. All rights reserved. © 2019 Grundfos Holding A/S, all rights reserved.