

1. Manifolds 4" ANSI Class 150 AISI 316SS Schedule 10s ASTM A312 or ϕ 114.3mm x2mm
 2. Base/Frame AISI 304SS
 3. Standard system layout : panel right facing suction
 4. Full port ball valve ASTM
 5. UL Type 3R/12 rated electrical panel
- Note: panel size will vary with options

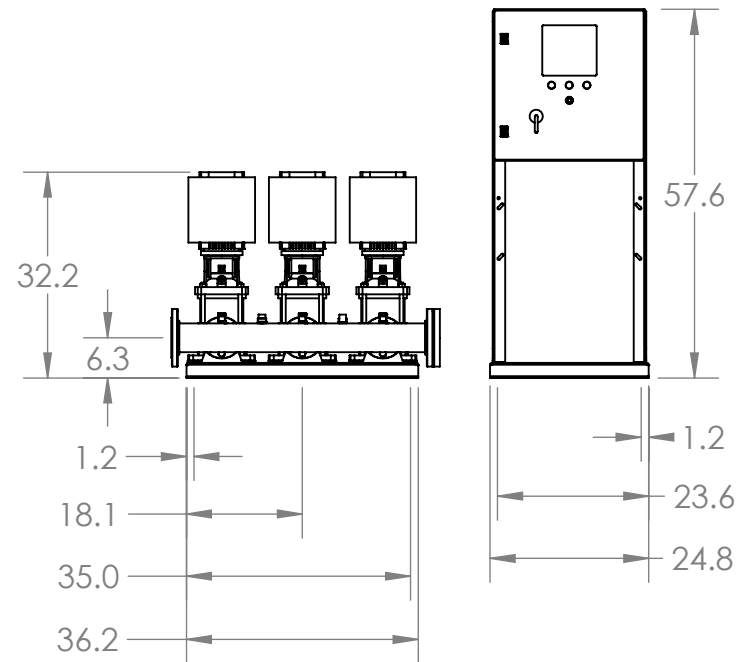
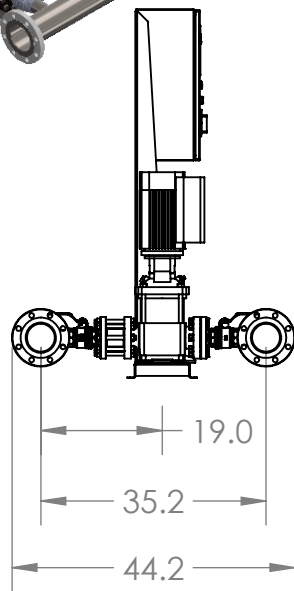
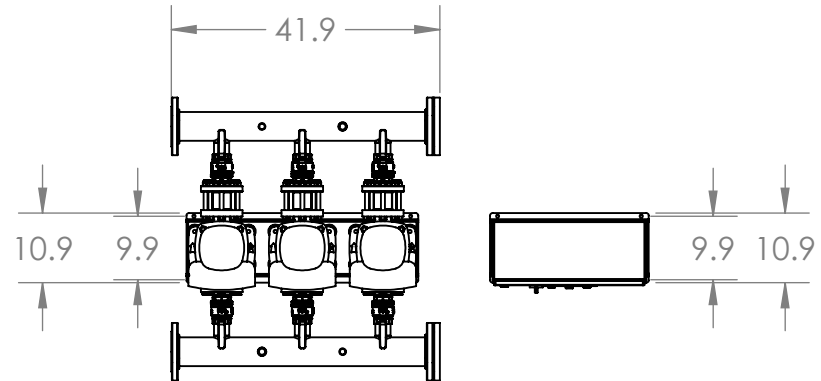
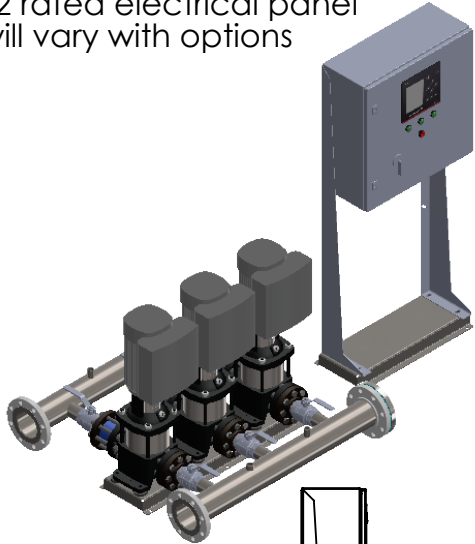

GRUNDFOS 
 FRESNO, CALIFORNIA 93727 USA

Note:
 All dimensions are $\pm 0.5"$
 Not for Construction
 All dimensions subject to
 changewithout notice.

BoosterpaQ Model: HYDRO MPC E 3CRE15-1

Power: 1x208-230 60HZ 3x2HP

Job:

Scale: 1:30

Dwg No:

Rev: 0

Date:

8/26/2019

Drawer

71999

Page:

1 of 1