

1. Manifolds 4" ANSI Class 150 AISI 316SS Schedule 10s ASTM A312 or  $\phi$  114.3mm x2mm
  2. Base/Frame AISI 304SS
  3. Standard system layout : panel right facing suction
  4. Full port ball valve ASTM
  5. UL Type 3R/12 rated electrical panel
- Note: panel size will vary with options

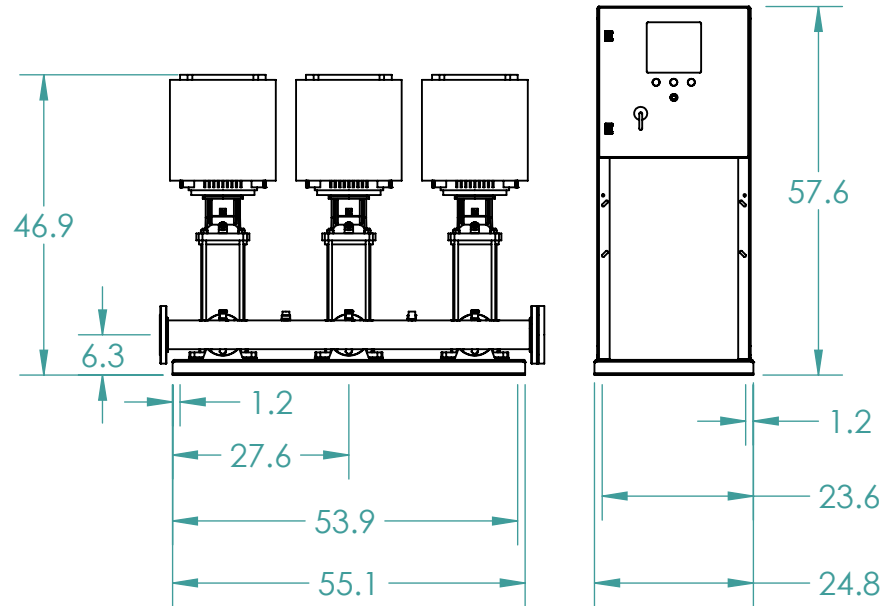
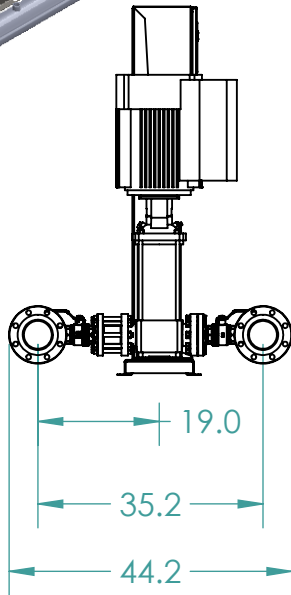
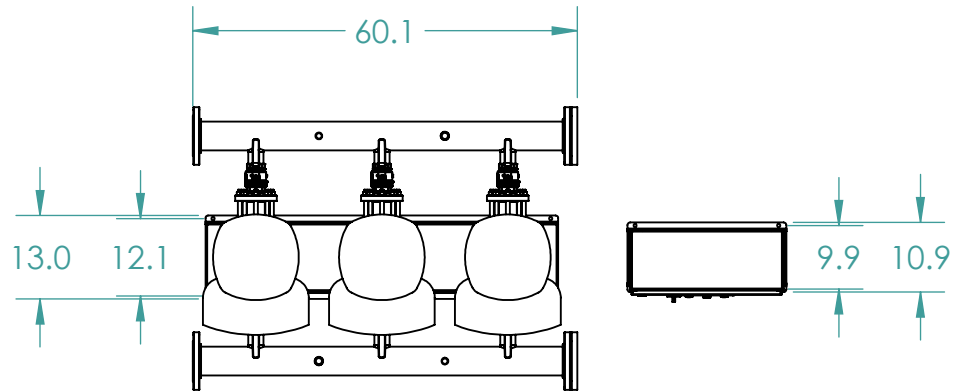
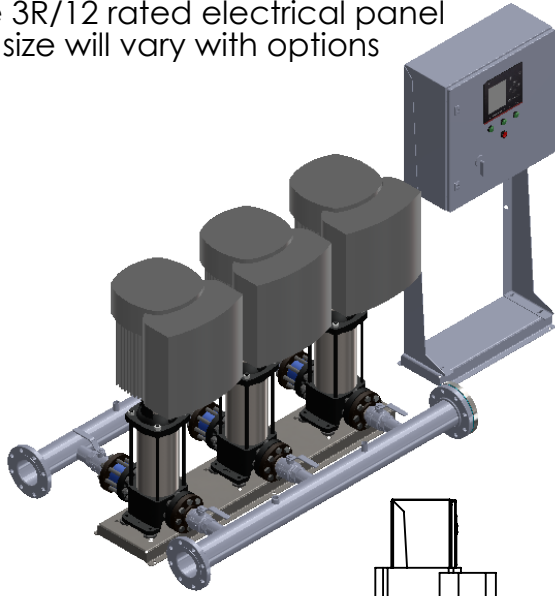

**GRUNDFOS**   
 FRESNO, CALIFORNIA 93727 USA

Note:  
 All dimensions are  $\pm 0.5"$   
 Not for Construction  
 All dimensions subject to  
 changewithout notice.

BoosterpaQ Model: HYDRO MPC E 3CRE20-5

Power: 3x460 60HZ 3x15HP

Job:

Scale: 1:30

Dwg No:

Rev: 0

Date:

5/21/2018

Drawer

71999

Page:

1 of 1