

1. Manifolds 2" NPT AISI 316SS Schedule 10s ASTM A312 or ϕ 60.3mm x2mm
2. Base/Frame AISI 304SS
3. Full port ball valve ASTM
4. UL Type 3R/12 rated electrical panel

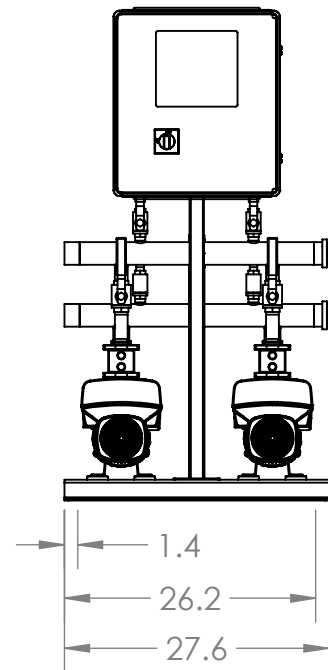
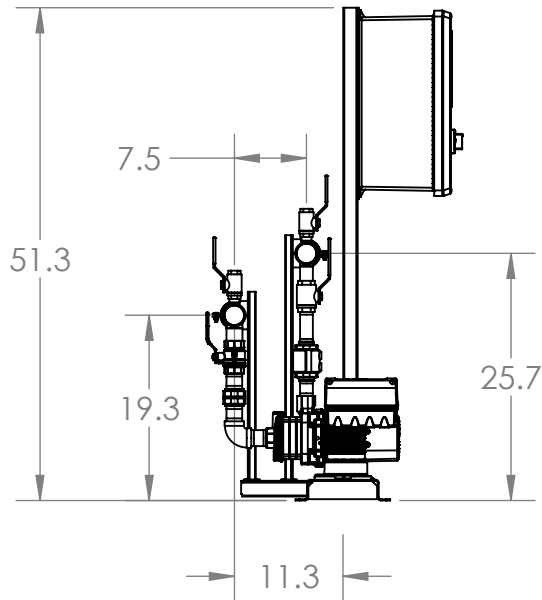
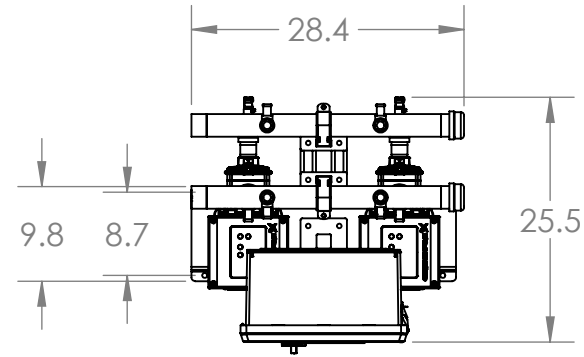
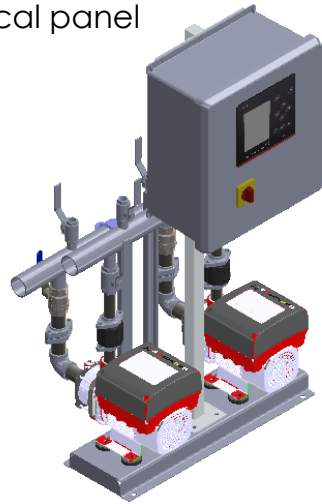

GRUNDFOS 
 FRESNO, CALIFORNIA 93727 USA

Note:
 All dimensions are $\pm 0.5"$
 Not for Construction
 All dimensions subject to
 changewithout notice.

BoosterpaQ Model: HYDRO MPC E 2CME5-4

Power: 3x460 60HZ 2x2HP

Job:

Scale: 1:20

Dwg No:

Rev: 0

Date: 6/18/2019

Drawer

71999

Page:

1 of 1