

1. Manifolds 4" ANSI Class 150 AISI 316SS Schedule 10s ASTM A312 or $\varnothing 114.3\text{mm} \times 2\text{mm}$
2. Base/Frame AISI 304SS
3. Full port ball valve ASTM
4. UL Type 3R/12 rated electrical panel

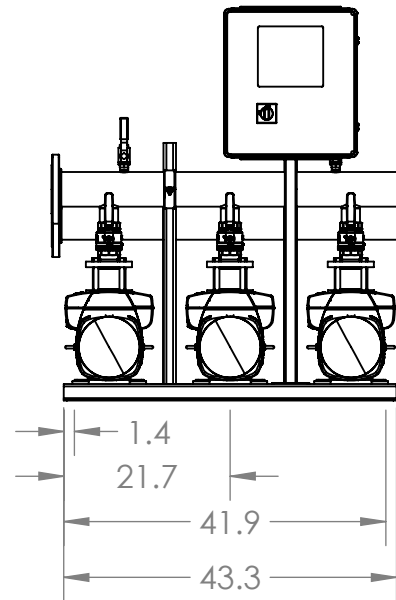
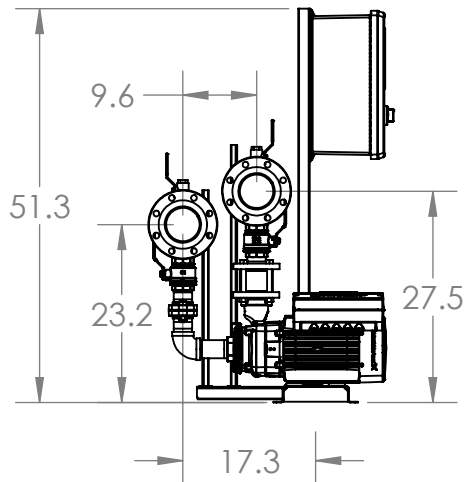
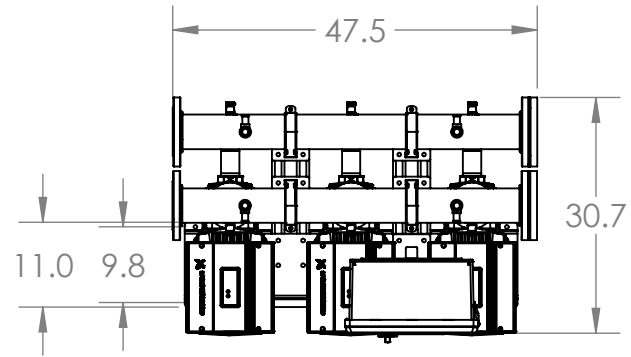
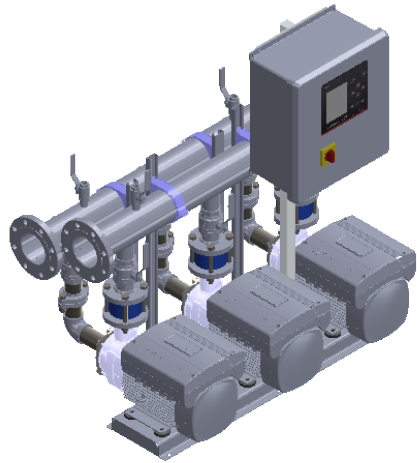

GRUNDFOS 
 FRESNO, CALIFORNIA 93727 USA

Note:
 All dimensions are $\pm 0.5"$
 Not for Construction
 All dimensions subject to
 changewithout notice.

BoosterpaQ Model: HYDRO MPC E 3CME15-2

Power: 3x208-230 60HZ 3x5HP

Job:

Scale: 1:25

Dwg No:

Rev: 0

Date:

6/20/2019

Drawer

71999

Page:

1 of 1