

1. Manifolds 2.5" NPT Class 150 AISI 316SS Schedule 10s ASTM A312 or  $\phi 76.1\text{mm} \times 2\text{mm}$
2. Base/Frame AISI 304SS
3. Full port ball valve ASTM
4. UL Type 3R/12 rated electrical panel

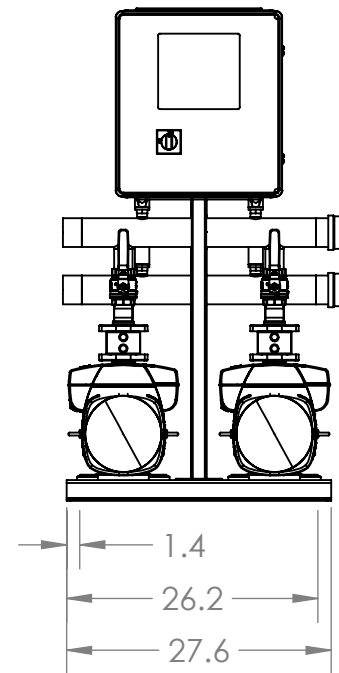
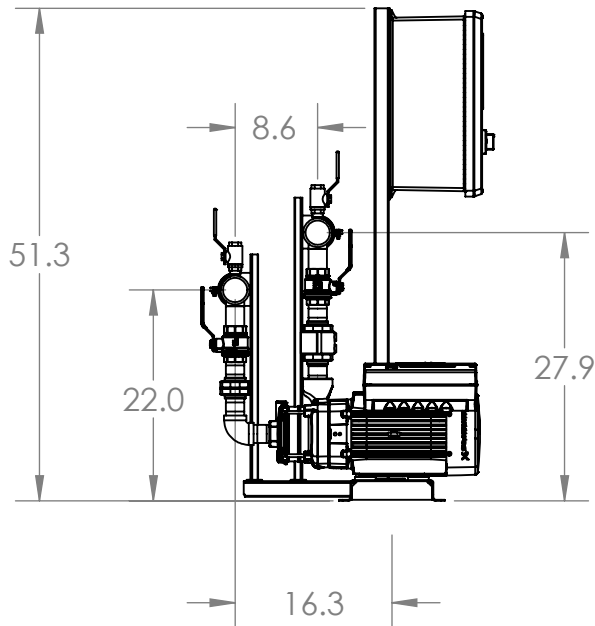
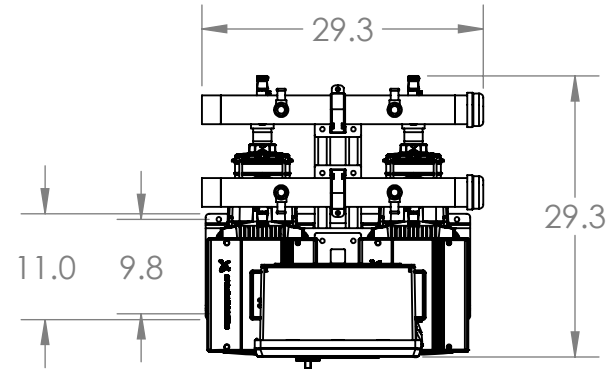
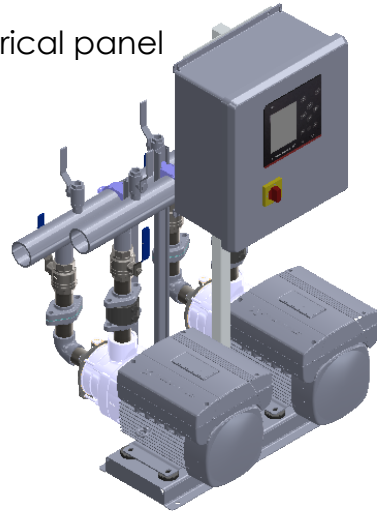

**GRUNDFOS**   
 FRESNO, CALIFORNIA 93727 USA

Note:  
 All dimensions are  $\pm 0.5"$   
 Not for Construction  
 All dimensions subject to  
 changewithout notice.

BoosterpaQ Model: HYDRO MPC E 2CME10-3

Power: 3x208-230 60HZ 2x5HP

Job:

Scale: 1:20

Dwg No:

Rev: 0

Date: 6/18/2019

Drawer

71999

Page:

1 of 1