

1. Manifolds 2.5" NPT Class 150 AISI 316SS Schedule 10s ASTM A312 or $\phi 76.1\text{mm} \times 2\text{mm}$
2. Base/Frame AISI 304SS
3. Full port ball valve ASTM
4. UL Type 3R/12 rated electrical panel

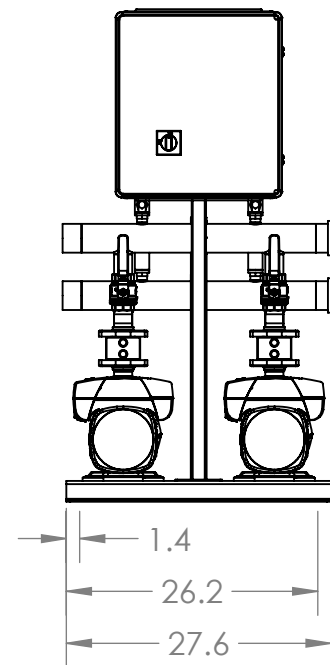
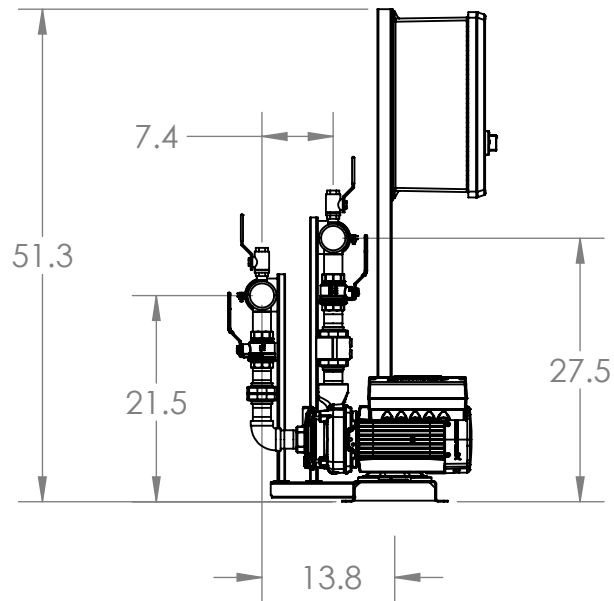
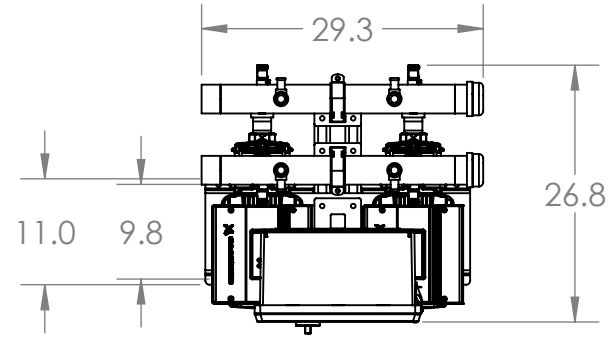
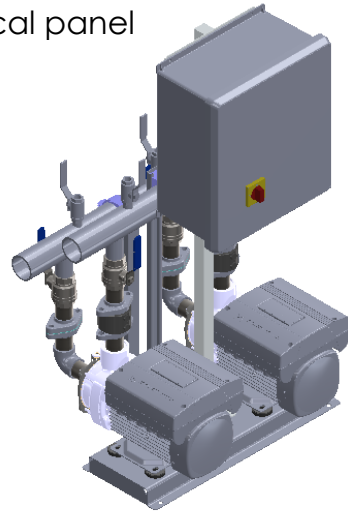

GRUNDFOS 
 FRESNO, CALIFORNIA 93727 USA

Note:
 All dimensions are $\pm 0.5"$
 Not for Construction
 All dimensions subject to
 changewithout notice.

BoosterpaQ Model: HYDRO MPC E 2CME10-2

Power: 3x208-230 60HZ 2x3HP

Job:

Scale: 1:20

Dwg No:

Rev: 0

Date: 6/18/2019

Drawer 71999

Page:

1 of 1