

1. Manifolds 2" NPT AISI 316SS Schedule 10s ASTM A312 or  $\phi$  60.3mm x2mm
2. Base/Frame AISI 304SS
3. Full port ball valve ASTM
4. UL Type 3R/12 rated electrical panel

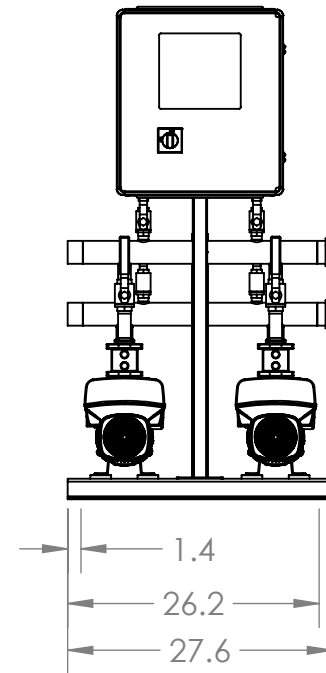
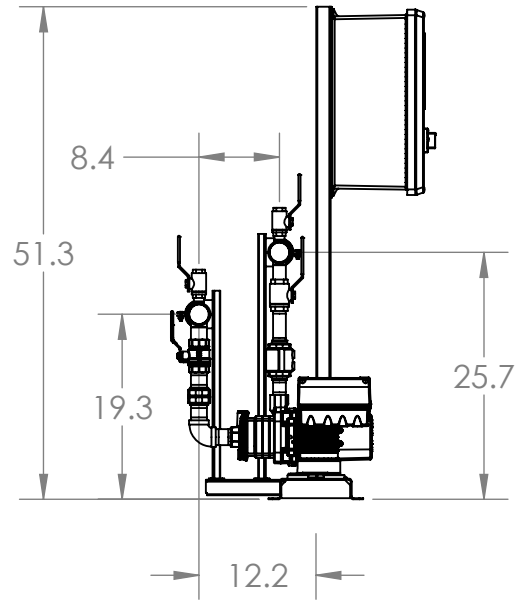
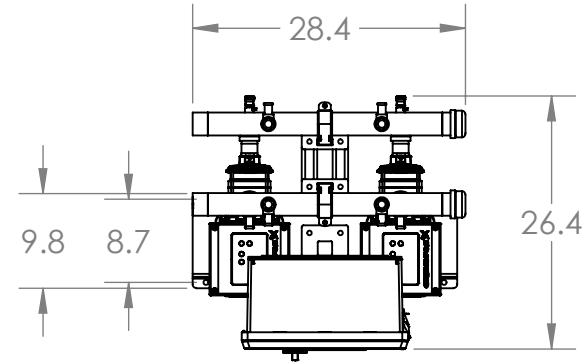
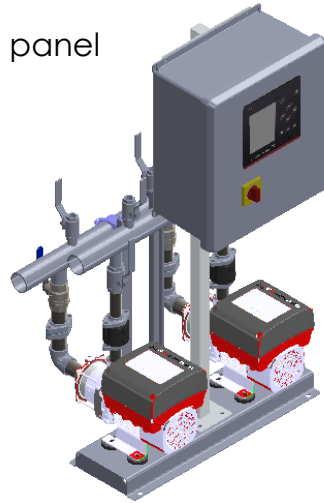

**GRUNDFOS**   
 FRESNO, CALIFORNIA 93727 USA

Note:  
 All dimensions are  $\pm 0.5"$   
 Not for Construction  
 All dimensions subject to  
 changewithout notice.

BoosterpaQ Model:		HYDRO MPC E 2CME5-5	
Power:		3x208-230 60HZ 2x2HP	
Job:		Scale: 1:20	
Dwg No:	Rev: 0	Date: 6/18/2019	Drawer 71999 Page: 1 of 1