

# 99034496 SLV.30.A30 .125.EX.2.60J.C 60 Hz

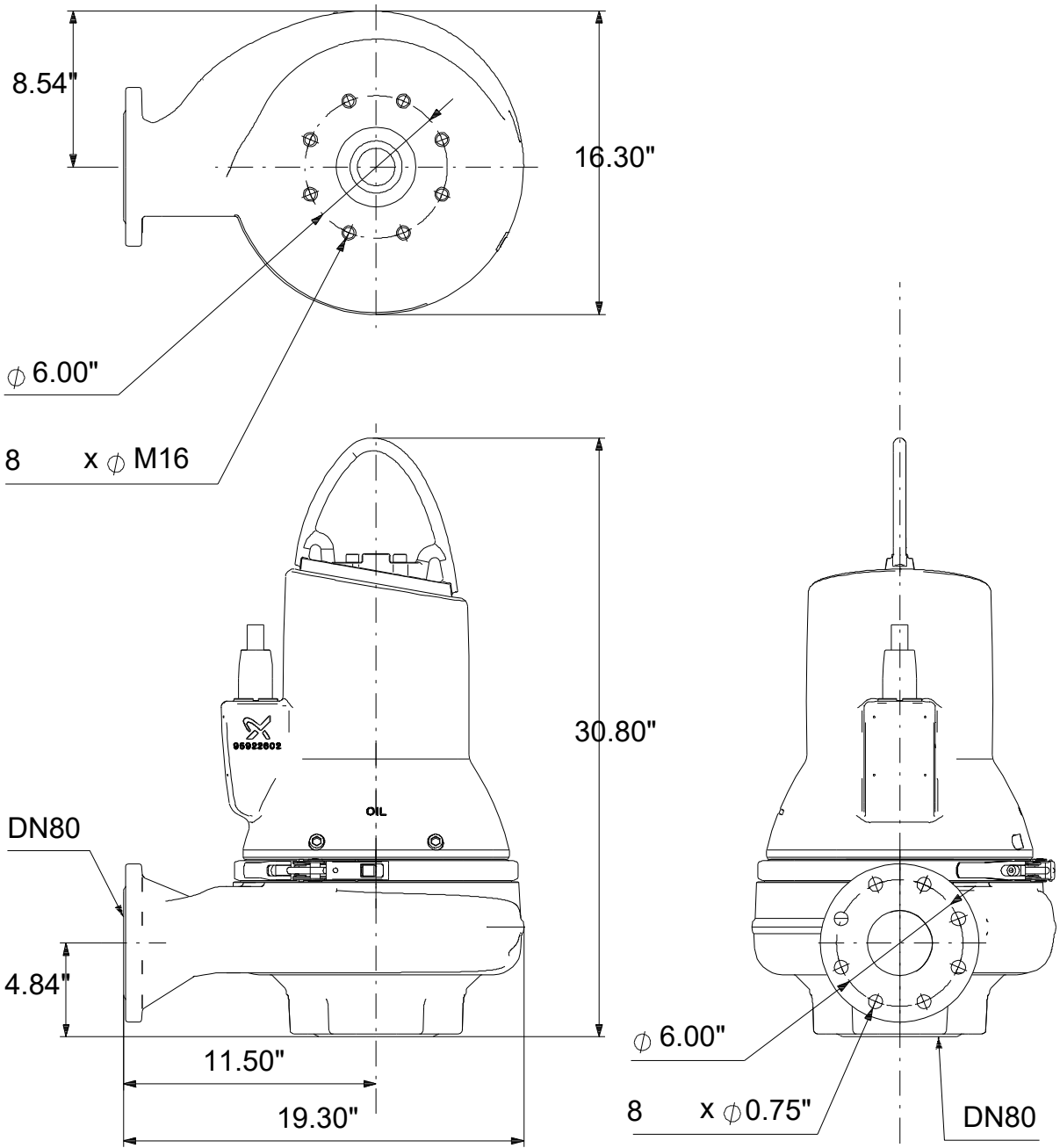

Note! All units are in [in] unless others are stated.  
Disclaimer: This simplified dimensional drawing does not show all details.

# 99034496 SLV.30.A30 .125.EX.2.60J.C 60 Hz

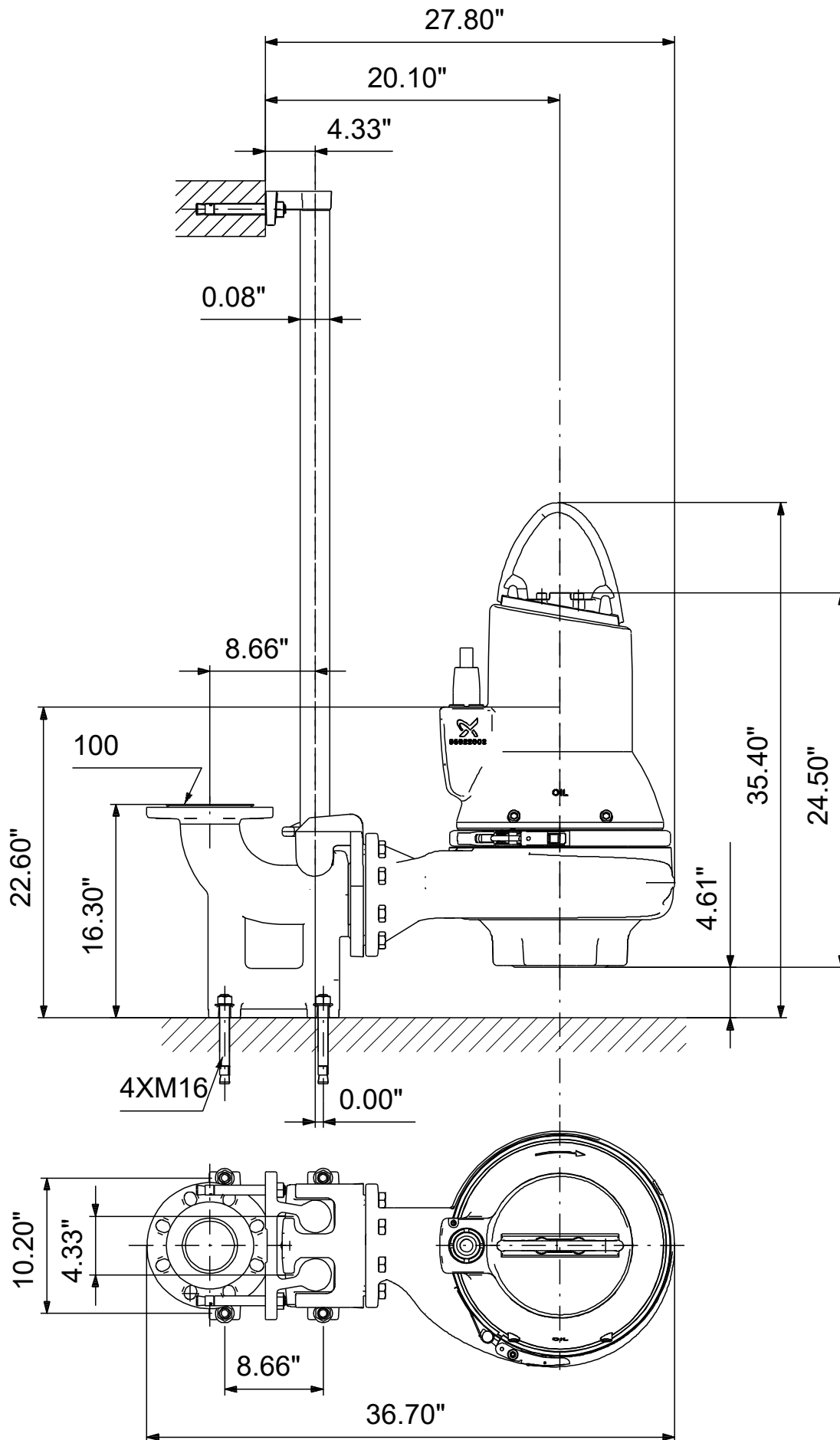

Note! All units are in [in] unless others are stated  
Disclaimer: This simplified dimensional drawing does not show all details.

99034496 SLV.30.A30 .125.EX.2.60J.C 60 Hz

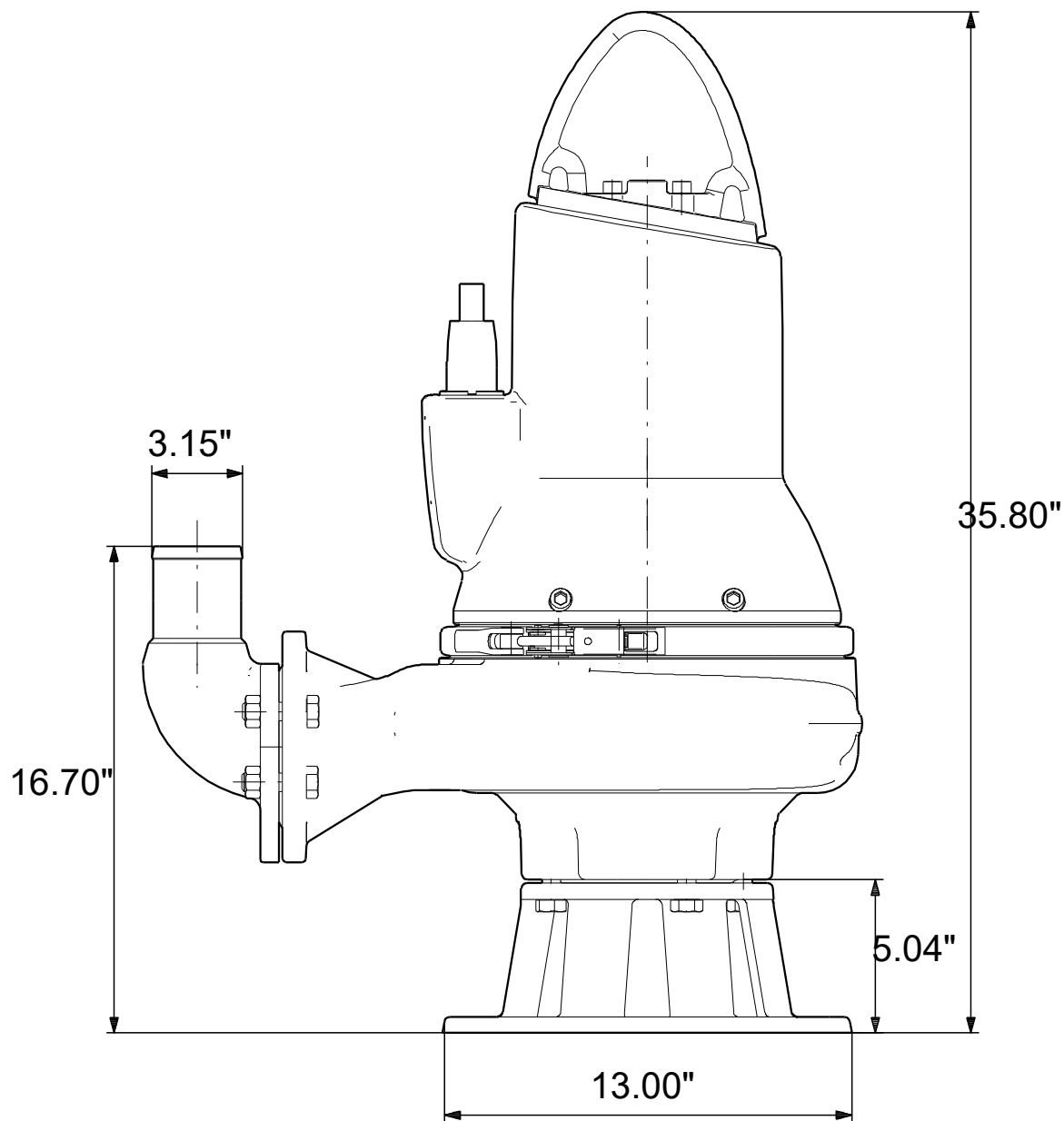
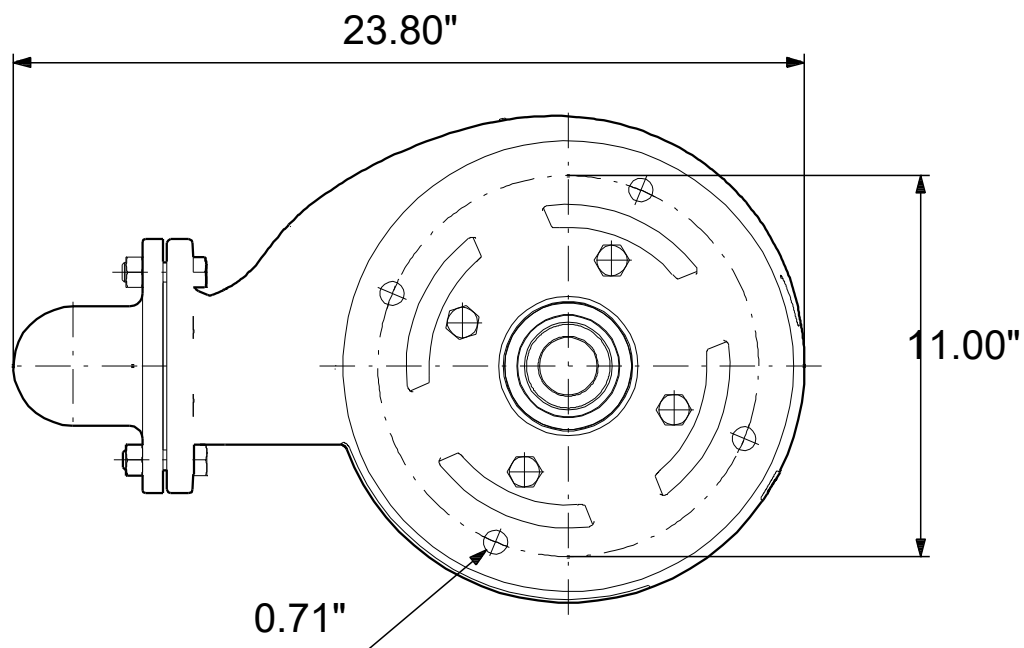

Note! All units are in [in] unless others are stated.  
Disclaimer: This simplified dimensional drawing does not show all details.