

# 99030273 SLV.30.A40 .80.EX.2.61R.C 60 Hz

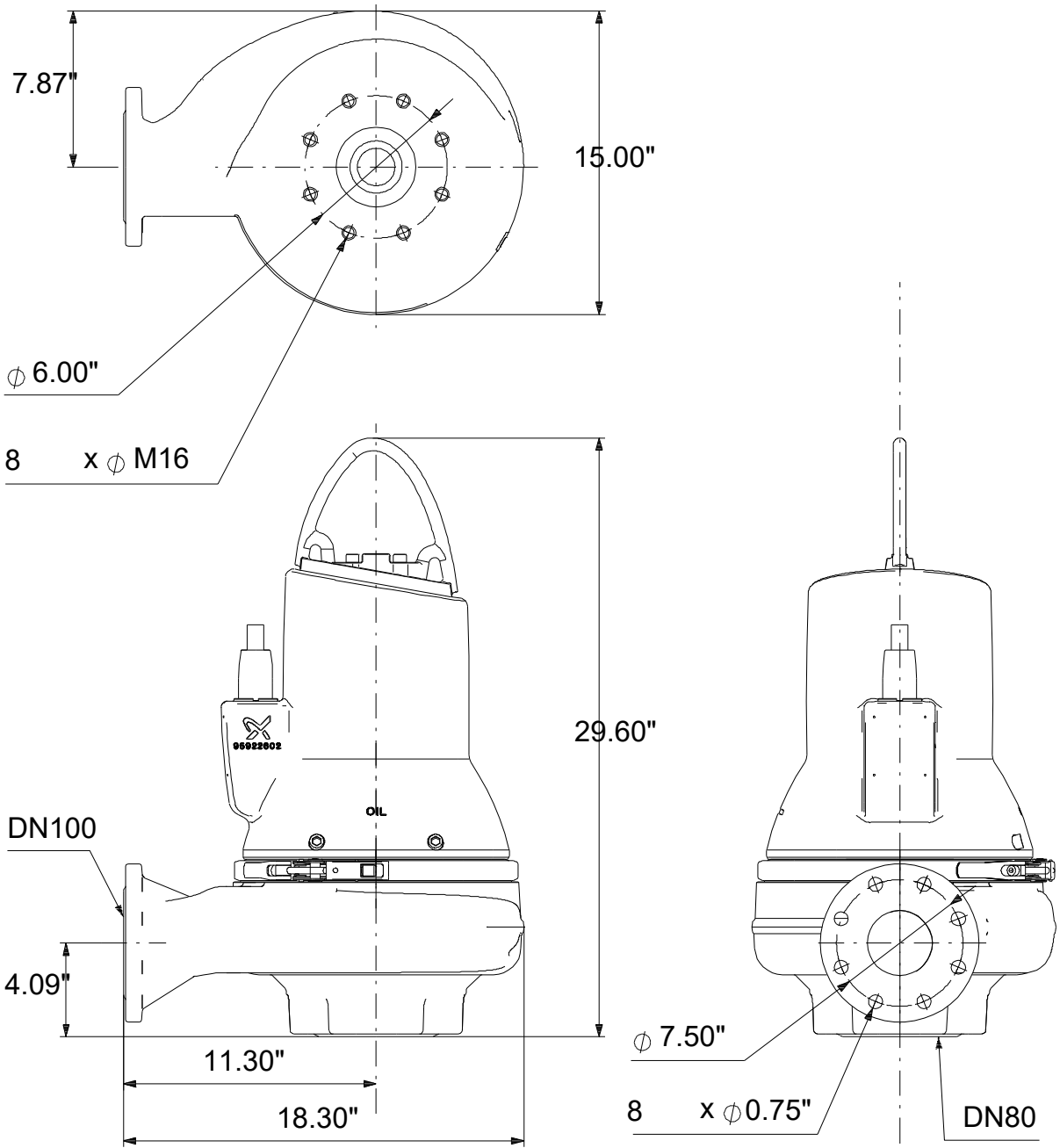

Note! All units are in [in] unless others are stated.  
Disclaimer: This simplified dimensional drawing does not show all details.

# 99030273 SLV.30.A40 .80.EX.2.61R.C 60 Hz

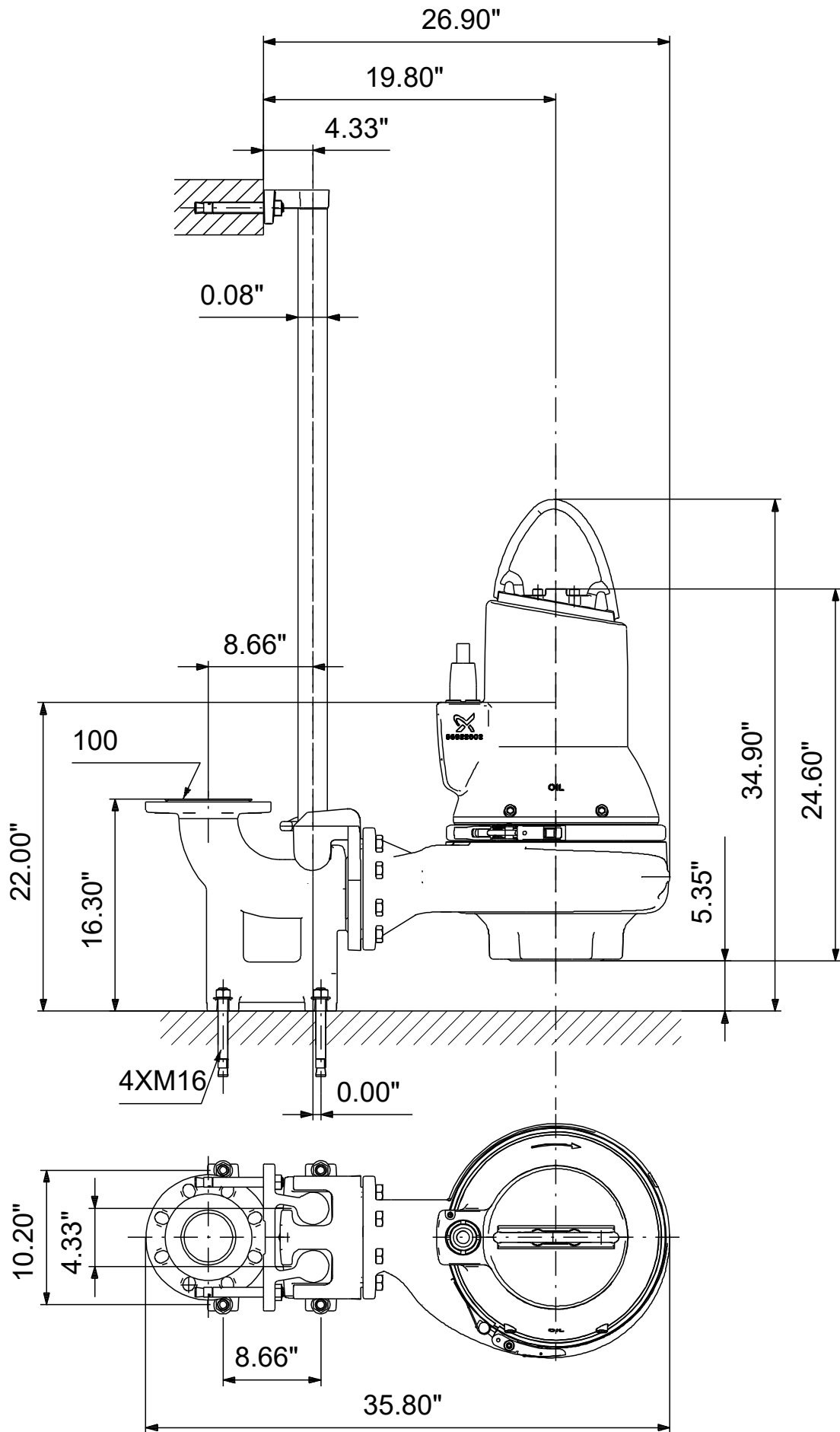

Note! All units are in [in] unless others are stated  
Disclaimer: This simplified dimensional drawing does not show all details.

99030273 SLV.30.A40 .80.EX.2.61R.C 60 Hz

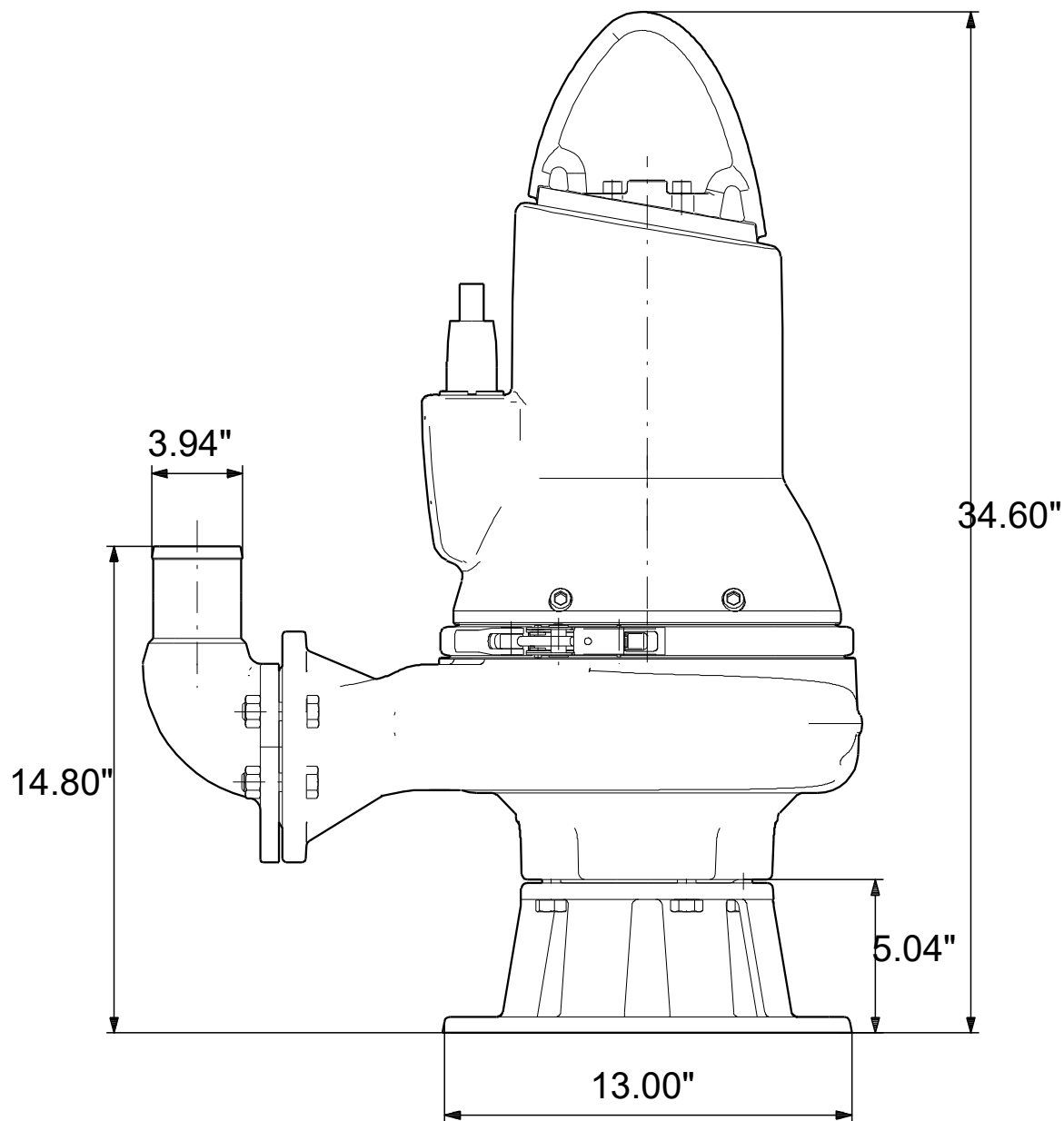
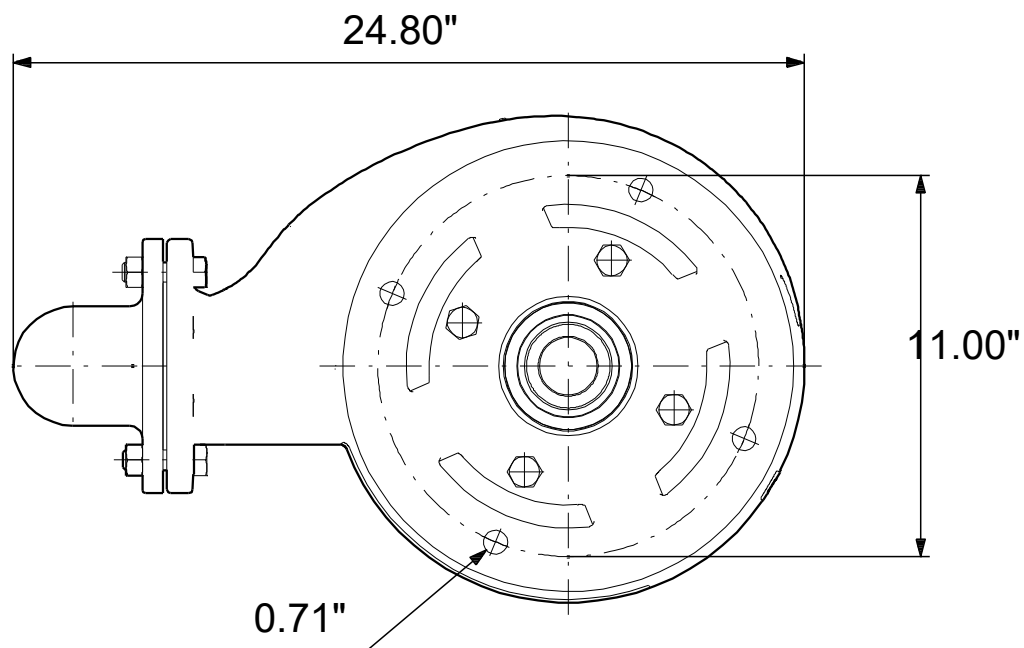

Note! All units are in [in] unless others are stated.  
Disclaimer: This simplified dimensional drawing does not show all details.