

99030259 SLV.25.A30 .55.EX.2.61R.C 60 Hz

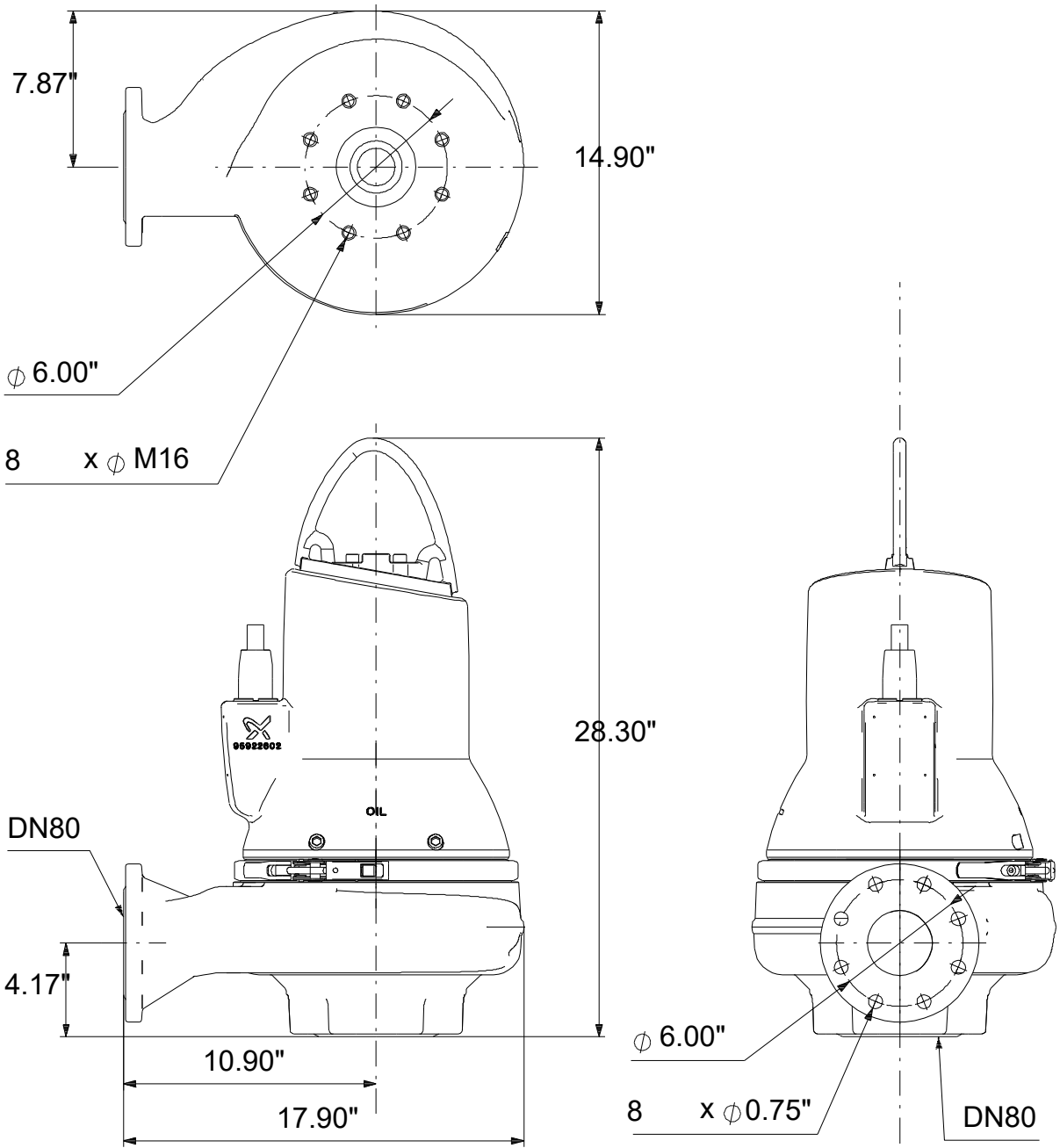

Note! All units are in [in] unless others are stated.
Disclaimer: This simplified dimensional drawing does not show all details.

99030259 SLV.25.A30 .55.EX.2.61R.C 60 Hz

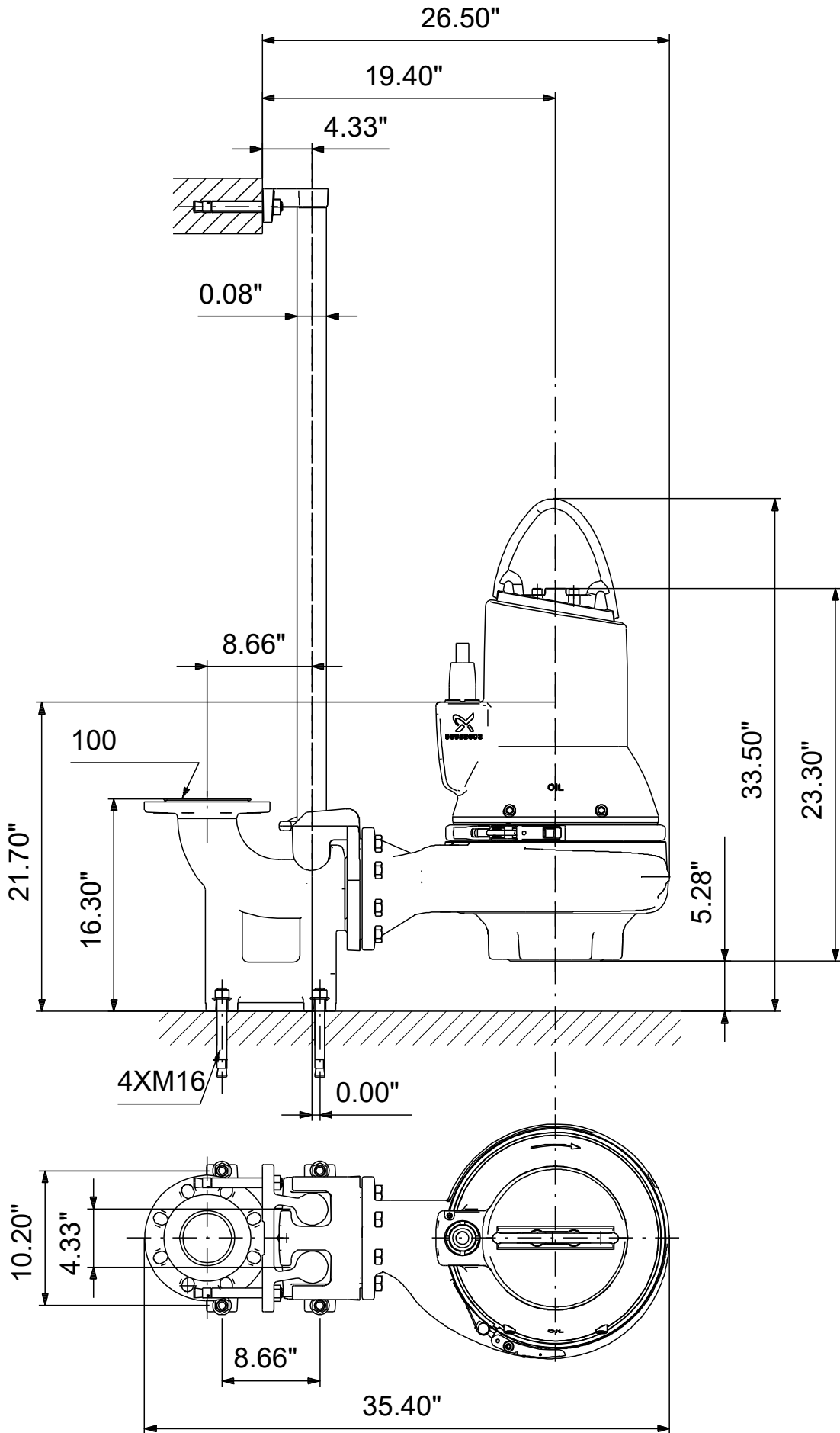

Note! All units are in [in] unless others are stated
 Disclaimer: This simplified dimensional drawing does not show all details.

99030259 SLV.25.A30 .55.EX.2.61R.C 60 Hz

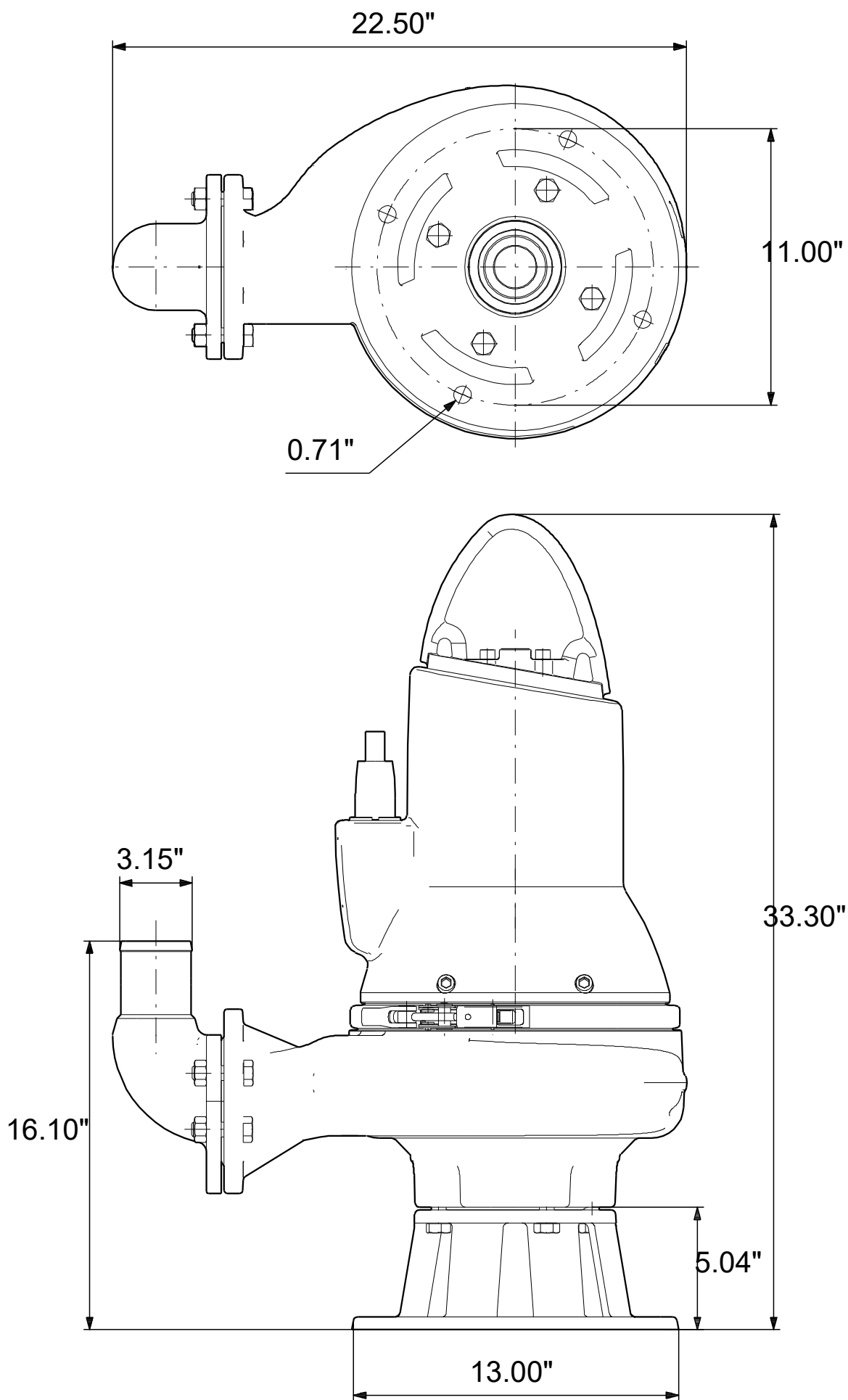

Note! All units are in [in] unless others are stated.
Disclaimer: This simplified dimensional drawing does not show all details.