

1. Manifolds 3" NPT Class 150 AISI 316SS Schedule 10s ASTM A312 or \varnothing 88.9mm x2mm
2. Base/Frame AISI 304SS
3. Full port ball valve ASTM
4. UL Type 3R Fuse Box

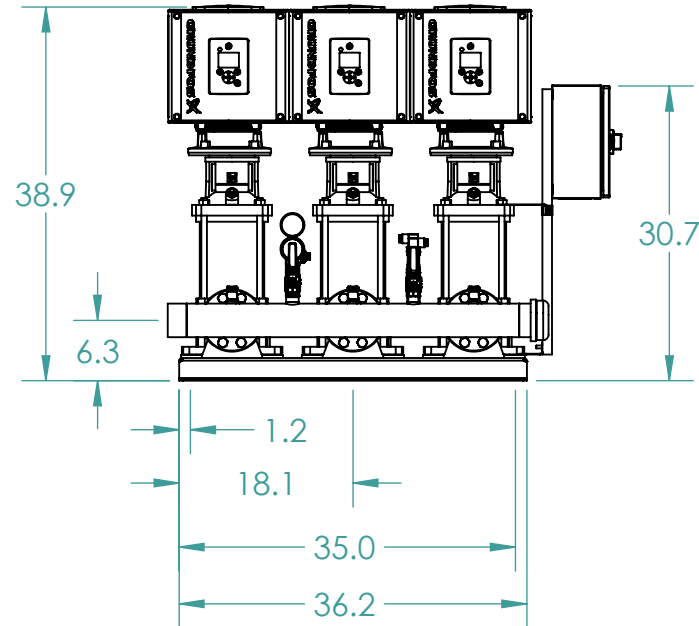
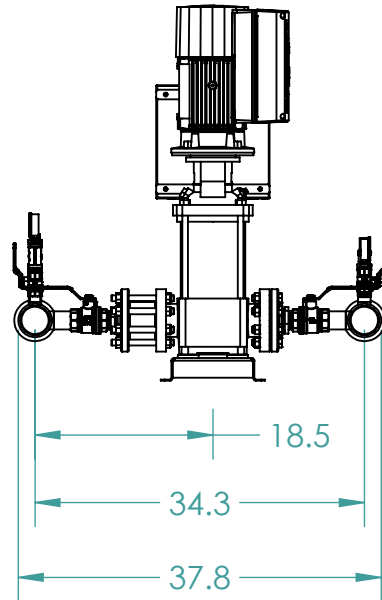
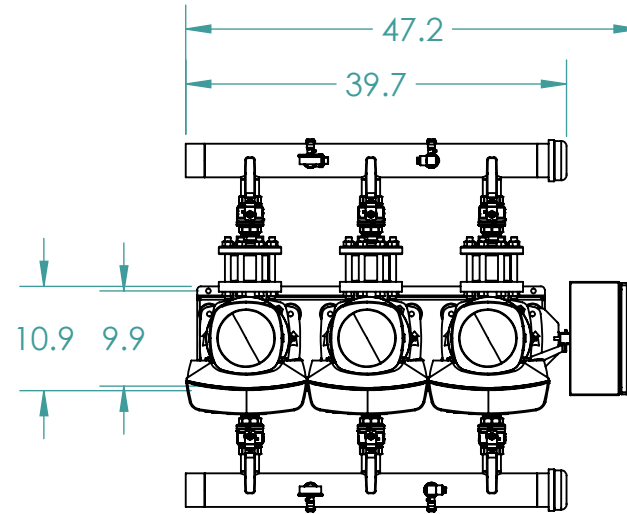
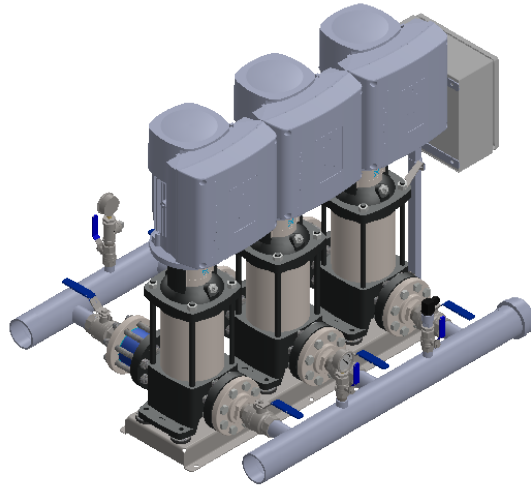

GRUNDFOS 
 FRESNO, CALIFORNIA 93727 USA

Note:
 All dimensions are $\pm 0.5"$
 Not for Construction
 All dimensions subject to
 changewithout notice.

BoosterpaQ Model: HYDRO MULTI-E 3CRE10-6

Power: 3x208-230 60HZ 3x5HP

Job:

Scale: 1:20

Dwg No: 99445656

Rev: 0

Date: 5/24/2018

Drawer 71999

Page: 1 of 1