

Manifolds 8" ANSI Class 150 AISI 316SS Schedule 10s ASTM A312 or  $\varnothing 219.1\text{mm} \times 2\text{mm}$   
 Base/Frame AISI 304SS  
 Standard system layout : panel right facing suction  
 4" lug style ANSI 150# class butterfly valve  
 UL Type 3R/12 rated electrical panel  
 Note: panel size will vary with options

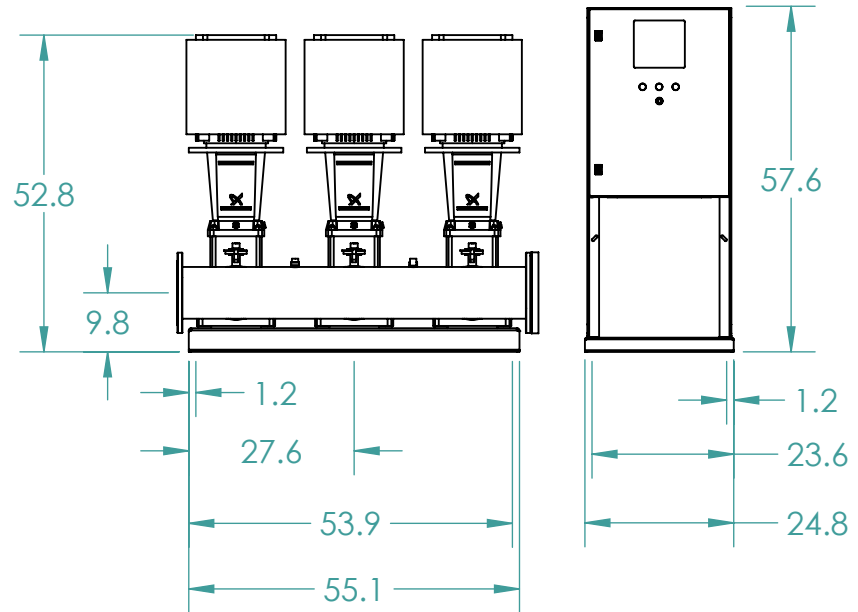
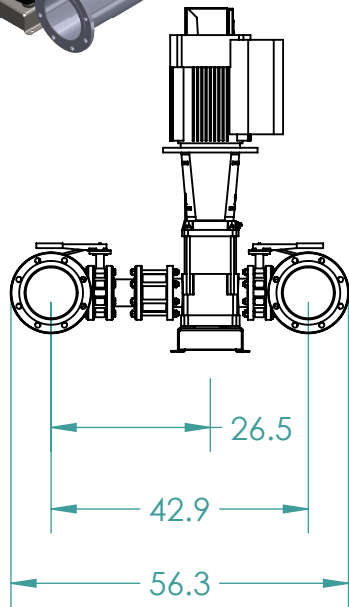
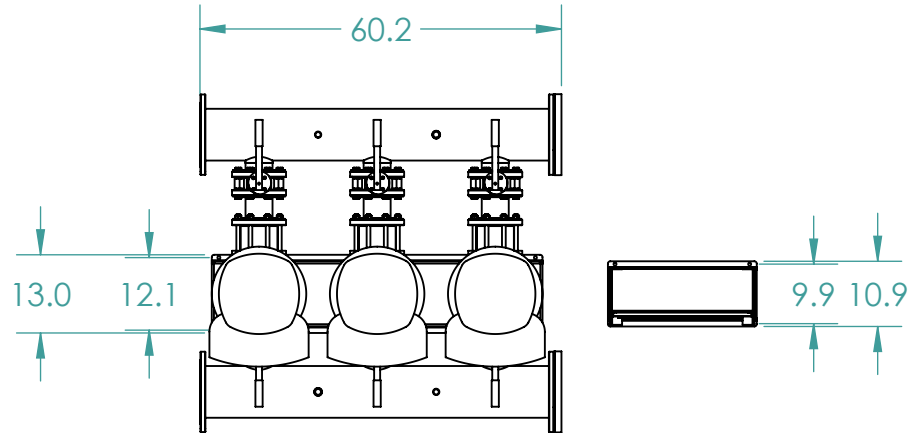
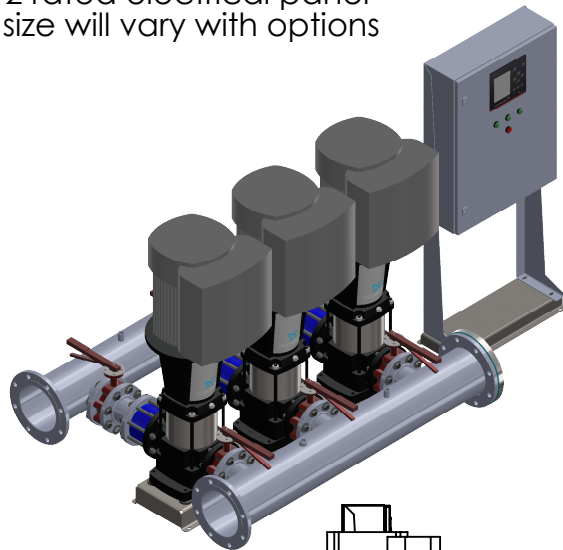

**GRUNDFOS**   
 FRESNO, CALIFORNIA 93727 USA

Note:  
 All dimensions are  $\pm 0.5"$   
 Not for Construction  
 All dimensions subject to  
 changewithout notice.

BoosterpaQ Model: HYDRO MPC E 3CRE64-2

Power: 3x460 60HZ 3x25HP

Job:

Scale: 1:32

Dwg No:

Rev: 0

Date:

3/23/2020

Drawer

58847

Page:

1 of 1